



**IZIAL DENTAL SURGICAL**

Manufacturer And Exporter Of Surgical Dental & Manicure

**Tools For Life**



**Surgical Instruments**

**[WWW.IZIALSURGICAL.COM](http://WWW.IZIALSURGICAL.COM)**

**Izial Dental Surgical. is a manufacturing & export company established in 2010 Sialkot 51310 Pakistan. It has a deep understanding and experience in the field of all types of all instrument manufacturing.**

**It has amassed substantial goodwill and a reputation globally as a leading Manicure, dental and Veterinary instruments supplier in Sialkot Pakistan. Our products portfolio contains more than 3000+ diverse range of our instruments that are used by oral health care professionals in their different roles and specialties and certain types of instruments are unique to various therapeutic procedures.**

**We have been supplying our high-quality dental instruments in Europe, America, and other international markets. We are always looking for a new distributor, interested distributing and import companies can touch with us. Izial Dental Surgical. manufactured high-quality instruments that provide premier performance and durability.**

**They are environmentally safe and very effective regarding the safety of patients in any clinical condition without any compromise.**

**As a leading supplier of dental, beauty instruments, we are committed to all products manufactured with the highest quality**



**IZIAL DENTAL SURGICAL**  
Manufacturer And Exporter Of Surgical Dental & Manicure

**Skalpellklingen, Skalpellgriffe, Messer**  
**Scalpel Blades, Scalpel Handles, Knives**  
**Hojas de bisturíes, Mangos de bisturíes, Cuchillos**  
**Lame per bisturi, Manici per bisturi, Coltelli**

Sterile Skalpelling, Skalpellinggriffe  
Sterile Scalpel Blades, Scalpel Handles  
Hojas de bisturíes estériles, Mangos de bisturíes  
Lame per bisturi sterili, Manici per bisturi



No. 3  
13,0 cm, 5"  
003-003-00



No. 3  
13,0 cm, 5"  
003-003-01



No. 3L  
21,0 cm, 8¼"  
003-003-02



No. 7  
16,5 cm, 6½"  
003-007-00



No. 7K  
13,0 cm, 5"  
003-007-01



**IZIAL DENTAL SURGICAL**  
Manufacturer And Exporter Of Surgical Dental & Manicure

**Sterile Skalpellklingen, Skalpellgriffe**  
**Sterile Scalpel Blades, Scalpel Handles**  
**Hojas de bisturíes estériles, Mangos de bisturíes**  
**Lame per bisturi sterili, Manici per bisturi**



**No. 4**  
13,5 cm, 5<sup>3</sup>/<sub>8</sub>"  
003-004-00



**No. 4L**  
21,0 cm, 8<sup>3</sup>/<sub>8</sub>"  
003-004-01



**No. 8**  
13,5 cm, 5<sup>3</sup>/<sub>8</sub>"  
003-008-00



**No. 9**  
14,5 cm, 5<sup>7</sup>/<sub>8</sub>"  
003-009-00

Einmal-Skalpelle, steril  
Disposable Scalpels, sterile  
Bisturios para uso único, estériles  
Bisturi monouso, sterili



Fig. 10  
003-050-10



Fig. 11  
003-050-11



Fig. 11s  
003-050-11S



Fig. 12  
003-050-12



Fig. 12d  
003-050-12D



Fig. 13  
003-050-13



Fig. 15  
003-050-15



Fig. 15c  
003-050-15C



**Fig. 18  
003-050-18**



**Fig. 19  
003-050-19**



**Fig. 20  
003-050-20**



**Fig. 21  
003-050-21**



**Fig. 22  
003-050-22**



**Fig. 23  
003-050-23**



**Fig. 24  
003-050-24**



Fig. 1 **003-066-01**  
Fig. 2 **003-066-02**  
Fig. 3 **003-066-03**



**OPERATION**  
17,0 cm, 6<sup>3</sup>/<sub>4</sub>"

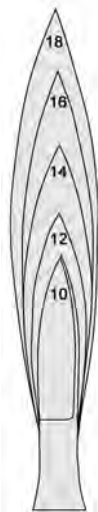


Fig. 10 **003-060-10**  
Fig. 12 **003-060-12**  
Fig. 14 **003-060-14**  
Fig. 16 **003-060-16**  
Fig. 18 **003-060-18**



**COLLIN**  
16,0 cm, 6<sup>1</sup>/<sub>4</sub>"



Fig. 4 **003-066-04**  
Fig. 5 **003-066-05**  
Fig. 6 **003-066-06**





Fig. 1 **003-070-01**  
Fig. 2 **003-070-02**  
Fig. 3 **003-070-03**  
Fig. 4 **003-070-04**  
Fig. 5 **003-070-05**



Fig. 1 **003-076-01**  
Fig. 2 **003-076-02**  
Fig. 3 **003-076-03**  
Fig. 4 **003-076-04**  
Fig. 5 **003-076-05**



Fig. 15 **003-078-15**



**DISSECTING**  
17,0 cm, 6¾"



Fig. 6 **003-070-06**  
Fig. 7 **003-070-07**  
Fig. 8 **003-070-08**  
Fig. 9 **003-070-09**  
Fig. 10 **003-070-10**



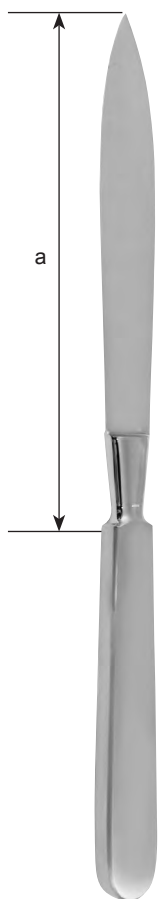
**DIEFENBACH**  
16,0 cm, 6¼"



Fig. 6 **003-076-06**  
Fig. 7 **003-076-07**  
Fig. 8 **003-076-08**  
Fig. 9 **003-076-09**

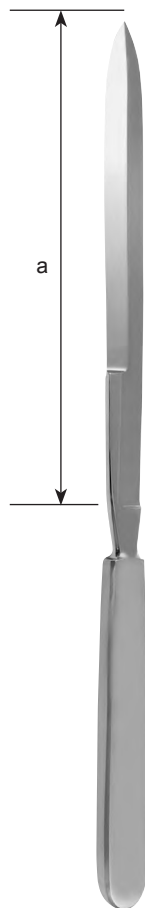


Fig. 16 **003-078-16**



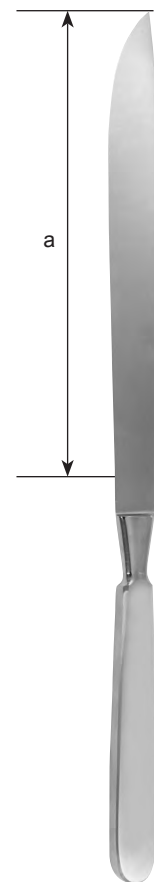
**COLLIN**

a	
13,0 cm, 5"	<b>003-080-13</b>
16,0 cm, 6 <sup>1</sup> / <sub>4</sub> "	<b>003-080-16</b>
19,0 cm, 7 <sup>1</sup> / <sub>2</sub> "	<b>003-080-19</b>
22,0 cm, 8 <sup>5</sup> / <sub>8</sub> "	<b>003-080-22</b>
28,0 cm, 11"	<b>003-080-28</b>



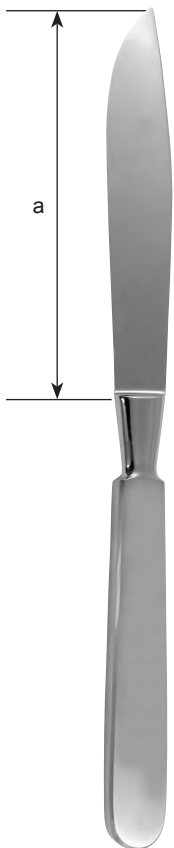
**CATLIN**

A	
16,0 cm, 6 <sup>1</sup> / <sub>4</sub> "	<b>003-082-16</b>
19,0 cm, 7 <sup>1</sup> / <sub>2</sub> "	<b>003-082-19</b>
22,0 cm, 8 <sup>5</sup> / <sub>8</sub> "	<b>003-082-22</b>

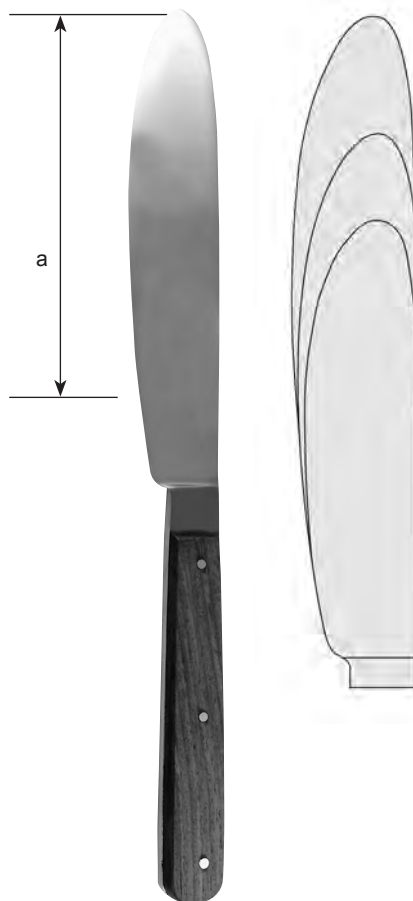


**LISTON**

A	
17,0 cm, 6 <sup>3</sup> / <sub>4</sub> "	<b>003-250-17</b>
20,0 cm, 8"	<b>003-250-20</b>
22,0 cm, 8 <sup>5</sup> / <sub>8</sub> "	<b>003-250-22</b>

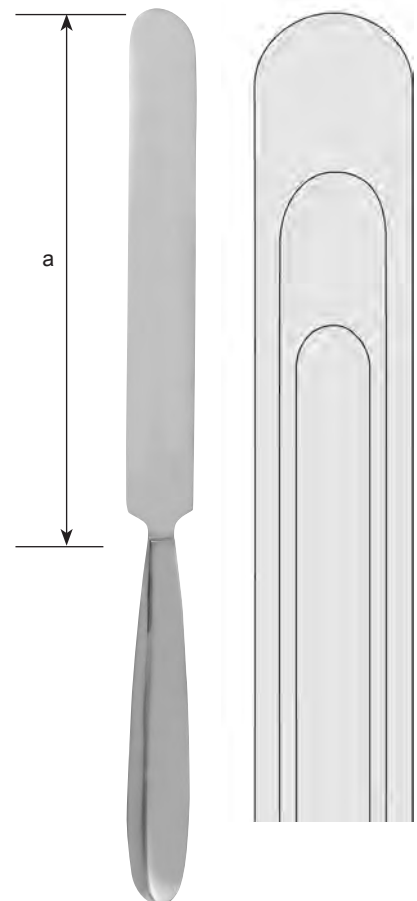


**LANGENBECK**  
003-280-12



**WALB**

A	
11,0 cm, 4 1/2"	<b>003-150-11</b>
14,0 cm, 5 1/2"	<b>003-150-14</b>
17,0 cm, 6 3/4"	<b>003-150-17</b>



**VIRCHOW**

A	
16,0 cm, 6 1/4"	<b>003-180-16</b>
20,0 cm, 8"	<b>003-180-20</b>
24,0 cm, 9 1/2"	<b>003-180-24</b>

Amputationsmesser, Dermatomye  
Amputation Knives, Dermatomyes  
Cuchillos para amputación, Dermátomos  
Coltelli per amputazione, Dermatomyi



**LANGENBECK**  
18,0 cm, 7"  
003-105-55



**CARTILAGE**  
17,5 cm, 6<sup>5</sup>/<sub>8</sub>"  
003-110-65

mit Schaber  
with raspatory  
con periostótomo  
con raschiatoio

Haut-Spannplatten  
Skin straightening plate  
Placa para extender la piel  
Placca per stendere la pelle



003-422-30



**003-401-19**  
Ersatzklinge  
Spare blade  
Hoja de repuesto  
Lama di ricambio



**SILVER**  
19 cm, 7 1/2"  
003-400-19

**003-411-30**  
Ersatzklinge  
Spare blade  
Hoja de repuesto  
Lama di ricambio



**BRAITHWAITE**  
30,0 cm, 12"  
003-410-30

**003-413-35**  
Ersatzklinge  
Spare blade  
Hoja de repuesto  
Lama di ricambio



**HUMBY**  
35,0 cm, 14"  
003-412-35

**003-421-30**  
Ersatzklinge  
Spare blade  
Hoja de repuesto  
Lama di ricambio



**SCHINK**  
30,0 cm, 12"  
003-420-30

**Scheren**

**Scissors**

**Tijeras**

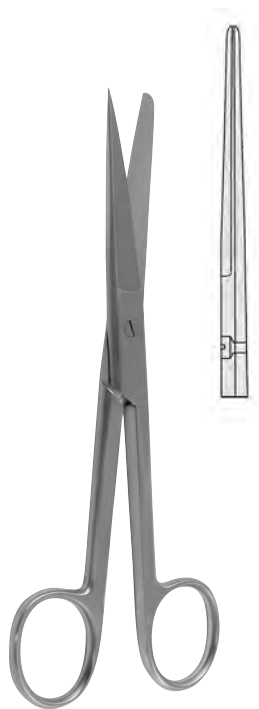
**Forbici**



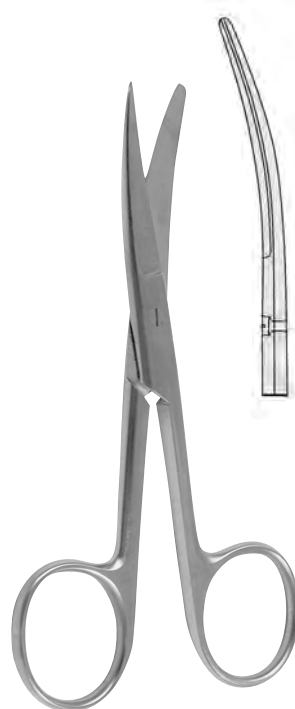
STANDARD	
10,5 cm, 4 <sup>1</sup> / <sub>4</sub> "	<b>010-000-10</b>
11,5 cm, 4 <sup>1</sup> / <sub>2</sub> "	<b>010-000-11</b>
13,0 cm, 5"	<b>010-000-13</b>
14,5 cm, 5 <sup>3</sup> / <sub>4</sub> "	<b>010-000-14</b>
15,5 cm, 6"	<b>010-000-15</b>
16,5 cm, 6 <sup>1</sup> / <sub>2</sub> "	<b>010-000-16</b>
17,5 cm, 6 <sup>5</sup> / <sub>8</sub> "	<b>010-000-17</b>
18,5 cm, 7 <sup>1</sup> / <sub>4</sub> "	<b>010-000-18</b>
20,0 cm, 8"	<b>010-000-20</b>



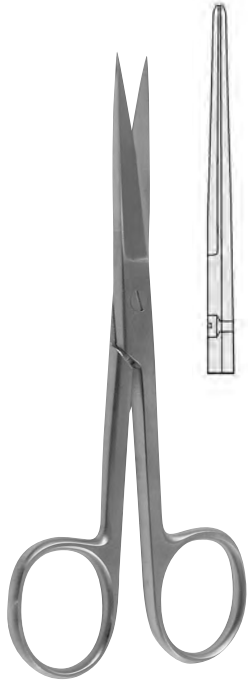
STANDARD	
10,5 cm, 4 <sup>1</sup> / <sub>4</sub> "	<b>010-001-10</b>
11,5 cm, 4 <sup>1</sup> / <sub>2</sub> "	<b>010-001-11</b>
13,0 cm, 5"	<b>010-001-13</b>
14,5 cm, 5 <sup>3</sup> / <sub>4</sub> "	<b>010-001-14</b>
15,5 cm, 6"	<b>010-001-15</b>
16,5 cm, 6 <sup>1</sup> / <sub>2</sub> "	<b>010-001-16</b>
17,5 cm, 6 <sup>5</sup> / <sub>8</sub> "	<b>010-001-17</b>
18,5 cm, 7 <sup>1</sup> / <sub>4</sub> "	<b>010-001-18</b>
20,0 cm, 8"	<b>010-001-20</b>



STANDARD	
10,5 cm, 4 <sup>1</sup> / <sub>4</sub> "	<b>010-002-10</b>
11,5 cm, 4 <sup>1</sup> / <sub>2</sub> "	<b>010-002-11</b>
13,0 cm, 5"	<b>010-002-13</b>
14,5 cm, 5 <sup>3</sup> / <sub>4</sub> "	<b>010-002-14</b>
15,5 cm, 6"	<b>010-002-15</b>
16,5 cm, 6 <sup>1</sup> / <sub>2</sub> "	<b>010-002-16</b>
17,5 cm, 6 <sup>5</sup> / <sub>8</sub> "	<b>010-002-17</b>
18,5 cm, 7 <sup>1</sup> / <sub>4</sub> "	<b>010-002-18</b>
20,0 cm, 8"	<b>010-002-20</b>

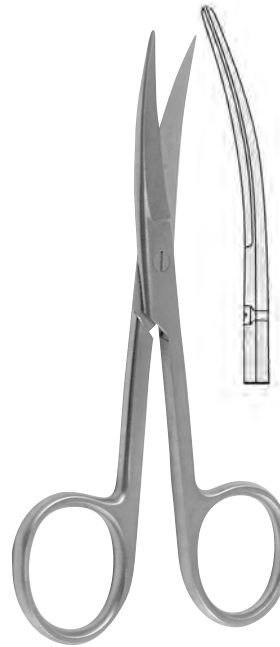


STANDARD	
10,5 cm, 4 <sup>1</sup> / <sub>4</sub> "	<b>010-003-10</b>
11,5 cm, 4 <sup>1</sup> / <sub>2</sub> "	<b>010-003-11</b>
13,0 cm, 5"	<b>010-003-13</b>
14,5 cm, 5 <sup>3</sup> / <sub>4</sub> "	<b>010-003-14</b>
15,5 cm, 6"	<b>010-003-15</b>
16,5 cm, 6 <sup>1</sup> / <sub>2</sub> "	<b>010-003-16</b>
17,5 cm, 6 <sup>5</sup> / <sub>8</sub> "	<b>010-003-17</b>
18,5 cm, 7 <sup>1</sup> / <sub>4</sub> "	<b>010-003-18</b>
20,0 cm, 8"	<b>010-003-20</b>



**STANDARD**

10,5 cm, 4 <sup>1</sup> / <sub>4</sub> "	<b>010-004-10</b>
11,5 cm, 4 <sup>1</sup> / <sub>2</sub> "	<b>010-004-11</b>
13,0 cm, 5"	<b>010-004-13</b>
14,5 cm, 5 <sup>3</sup> / <sub>4</sub> "	<b>010-004-14</b>
15,5 cm, 6"	<b>010-004-15</b>
16,5 cm, 6 <sup>1</sup> / <sub>2</sub> "	<b>010-004-16</b>
17,5 cm, 6 <sup>5</sup> / <sub>8</sub> "	<b>010-004-17</b>
18,5 cm, 7 <sup>1</sup> / <sub>4</sub> "	<b>010-004-18</b>
20,0 cm, 8"	<b>010-004-20</b>



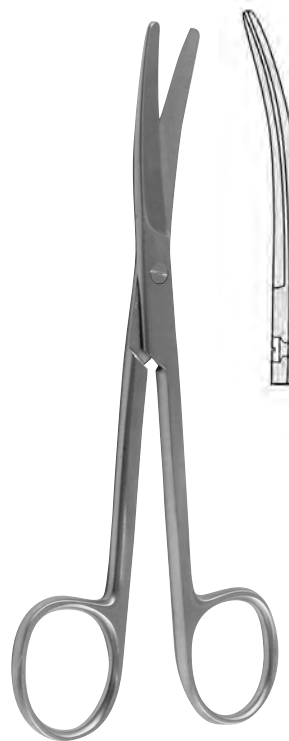
**STANDARD**

10,5 cm, 4 <sup>1</sup> / <sub>4</sub> "	<b>010-005-10</b>
11,5 cm, 4 <sup>1</sup> / <sub>2</sub> "	<b>010-005-11</b>
13,0 cm, 5"	<b>010-005-13</b>
14,5 cm, 5 <sup>3</sup> / <sub>4</sub> "	<b>010-005-14</b>
15,5 cm, 6"	<b>010-005-15</b>
16,5 cm, 6 <sup>1</sup> / <sub>2</sub> "	<b>010-005-16</b>
17,5 cm, 6 <sup>5</sup> / <sub>8</sub> "	<b>010-005-17</b>
18,5 cm, 7 <sup>1</sup> / <sub>4</sub> "	<b>010-005-18</b>
20,0 cm, 8"	<b>010-005-20</b>



**DEAVER**

12,0 cm, 4 <sup>3</sup> / <sub>4</sub> "	<b>010-050-12</b>
13,0 cm, 5"	<b>010-050-13</b>
14,5 cm, 5 <sup>3</sup> / <sub>4</sub> "	<b>010-050-14</b>

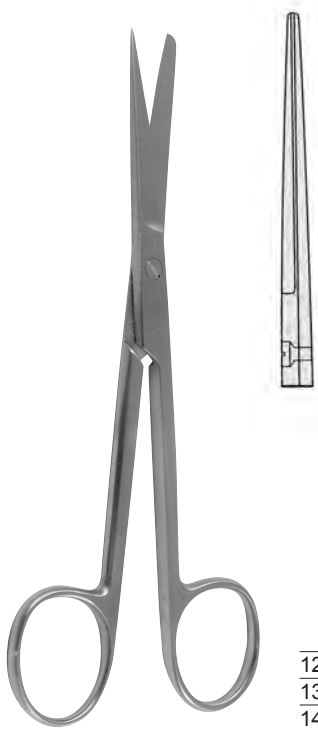


**DEAVER**

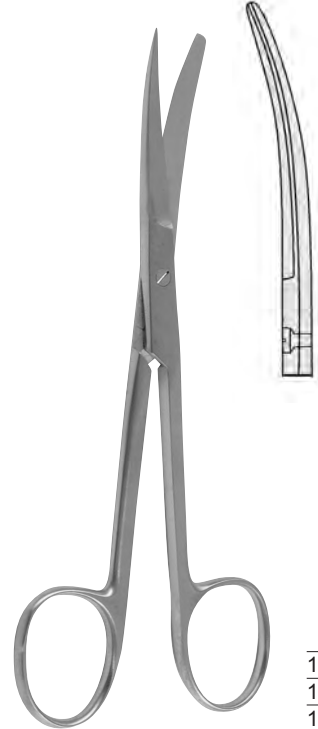
12,0 cm, 4 <sup>3</sup> / <sub>4</sub> "	<b>010-051-12</b>
13,0 cm, 5"	<b>010-051-13</b>
14,5 cm, 5 <sup>3</sup> / <sub>4</sub> "	<b>010-051-14</b>



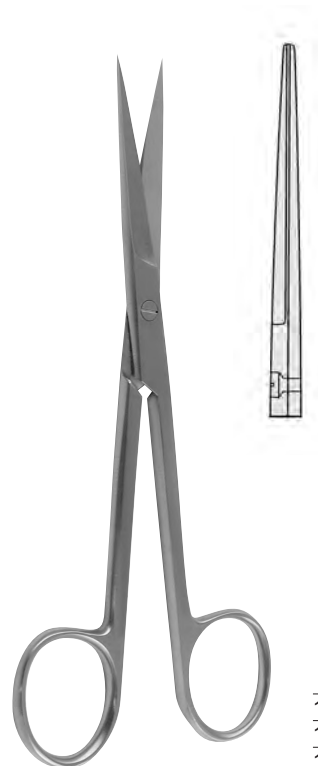
Präparierscheren  
 Dissecting Scissors  
 Tijeras de disección  
 Forbici per dissezione



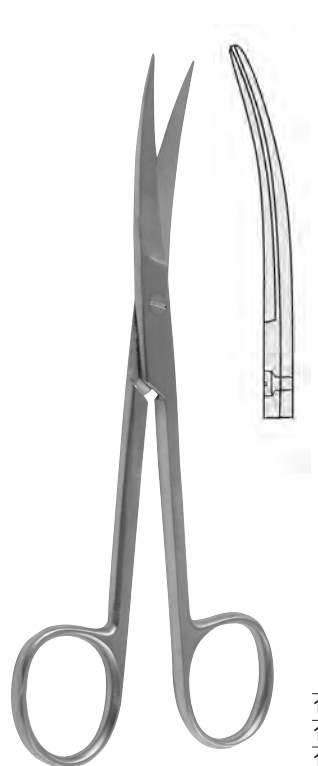
**DEAVER**  
 12,0 cm, 4<sup>3</sup>/<sub>4</sub>" **010-052-12**  
 13,0 cm, 5" **010-052-13**  
 14,5 cm, 5<sup>3</sup>/<sub>4</sub>" **010-052-14**



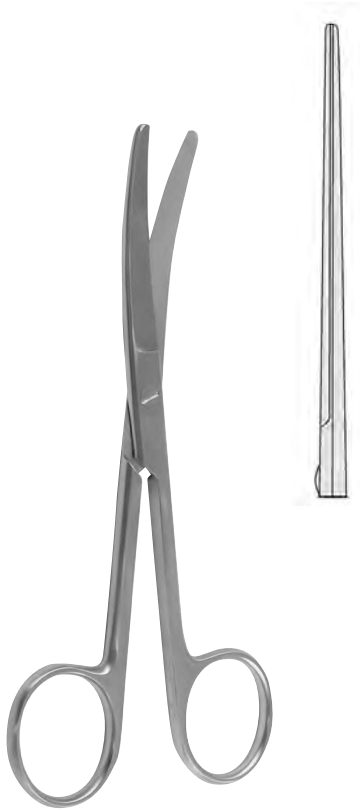
**DEAVER**  
 12,0 cm, 4<sup>3</sup>/<sub>4</sub>" **010-053-12**  
 13,0 cm, 5" **010-053-13**  
 14,5 cm, 5<sup>3</sup>/<sub>4</sub>" **010-053-14**



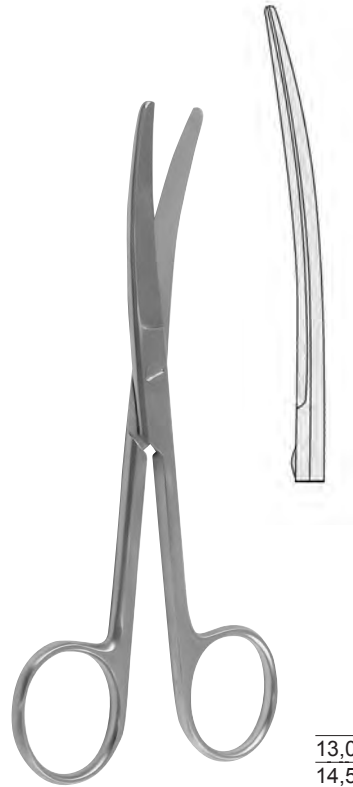
**DEAVER**  
 12,0 cm, 4<sup>3</sup>/<sub>4</sub>" **010-054-12**  
 13,0 cm, 5" **010-054-13**  
 14,5 cm, 5<sup>3</sup>/<sub>4</sub>" **010-054-14**



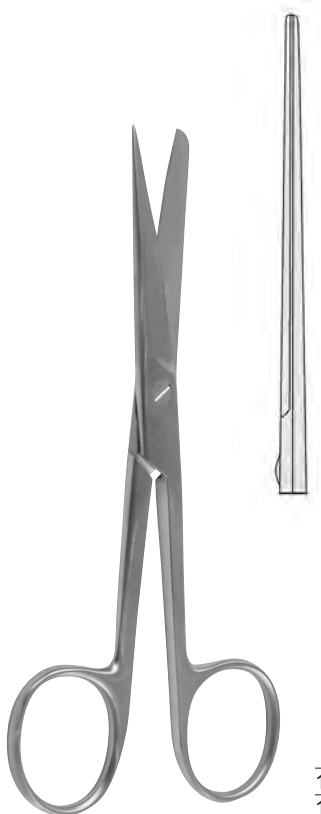
**DEAVER**  
 12,0 cm, 4<sup>3</sup>/<sub>4</sub>" **010-055-12**  
 13,0 cm, 5" **010-055-13**  
 14,5 cm, 5<sup>3</sup>/<sub>4</sub>" **010-055-14**



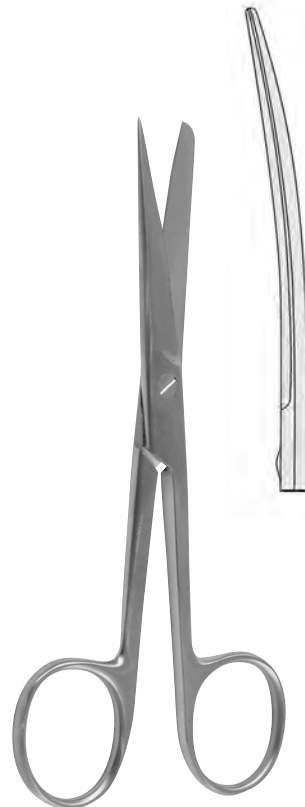
**GRAZIL**  
13,0 cm, 5"      **010-070-13**  
14,5 cm, 5<sup>3</sup>/<sub>4</sub>"      **010-070-14**



**GRAZIL**  
13,0 cm, 5"      **010-071-13**  
14,5 cm, 5<sup>3</sup>/<sub>4</sub>"      **010-071-14**

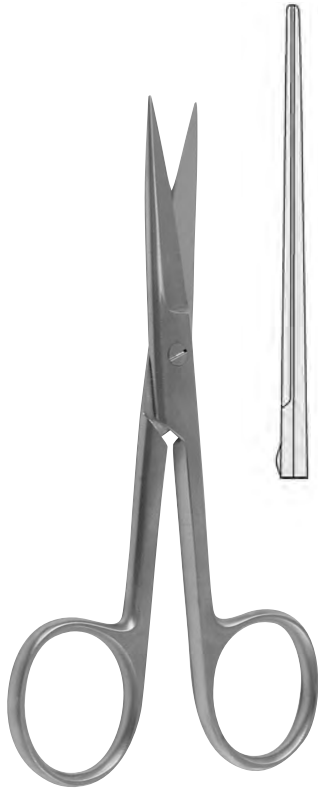


**GRAZIL**  
13,0 cm, 5"      **010-072-13**  
14,5 cm, 5<sup>3</sup>/<sub>4</sub>"      **010-072-14**

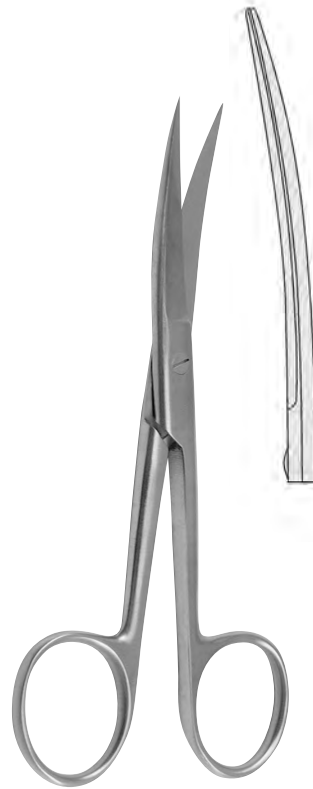


**GRAZIL**  
13,0 cm, 5"      **010-073-13**  
14,5 cm, 5<sup>3</sup>/<sub>4</sub>"      **010-073-14**

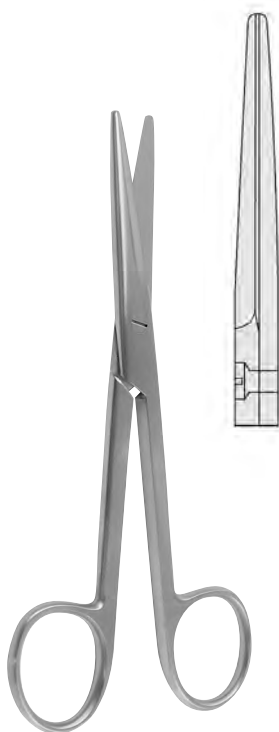
Präparierscheren  
 Dissecting Scissors  
 Tijeras de disección  
 Forbici per dissezione



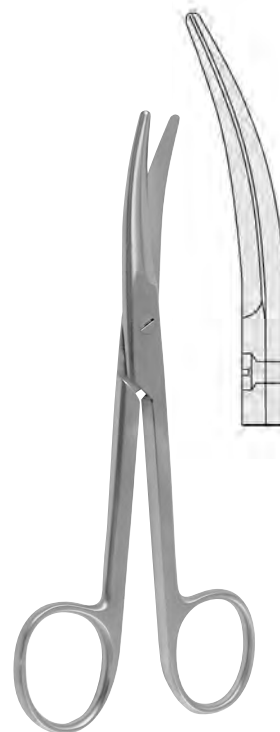
**GRAZIL**  
 13,0 cm, 5"      **010-074-13**  
 14,5 cm, 5<sup>3</sup>/<sub>4</sub>"      **010-074-14**



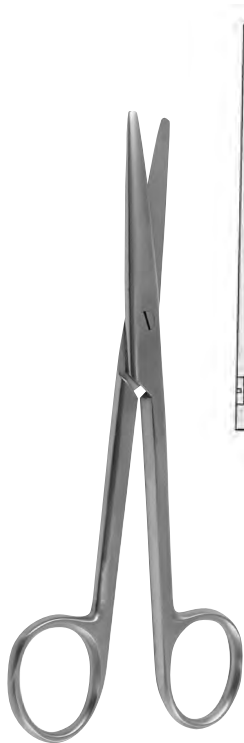
**GRAZIL**  
 13,0 cm, 5"      **010-075-13**  
 14,5 cm, 5<sup>3</sup>/<sub>4</sub>"      **010-075-14**



**MAYO**  
 14,5 cm, 5<sup>3</sup>/<sub>4</sub>"      **010-100-14**  
 17,0 cm, 6<sup>3</sup>/<sub>4</sub>"      **010-100-17**  
 23,0 cm, 9"      **010-100-23**  
 28,0 cm, 11"      **010-100-28**



**MAYO**  
 14,5 cm, 5<sup>3</sup>/<sub>4</sub>"      **010-101-14**  
 17,0 cm, 6<sup>3</sup>/<sub>4</sub>"      **010-101-17**  
 23,0 cm, 9"      **010-101-23**  
 28,0 cm, 11"      **010-101-28**



**MAYO-STILE**

15,0 cm, 6"	<b>010-102-15</b>
17,0 cm, 6 <sup>3</sup> / <sub>4</sub> "	<b>010-102-17</b>
19,5 cm, 7 <sup>3</sup> / <sub>4</sub> "	<b>010-102-19</b>
21,0 cm, 8 <sup>1</sup> / <sub>4</sub> "	<b>010-102-21</b>



**MAYO-STILE**

15,0 cm, 6"	<b>010-103-15</b>
17,0 cm, 6 <sup>3</sup> / <sub>4</sub> "	<b>010-103-17</b>
19,5 cm, 7 <sup>3</sup> / <sub>4</sub> "	<b>010-103-19</b>
21,0 cm, 8 <sup>1</sup> / <sub>4</sub> "	<b>010-103-21</b>



**010-104-17**



**010-105-17**

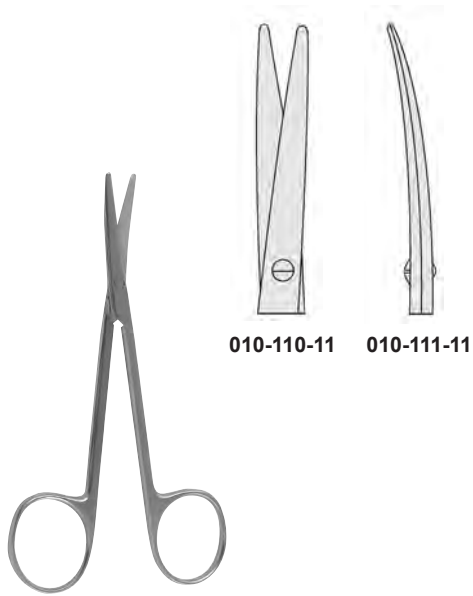
**MAYO-NOBLE**

17,0 cm, 6<sup>3</sup>/<sub>4</sub>"



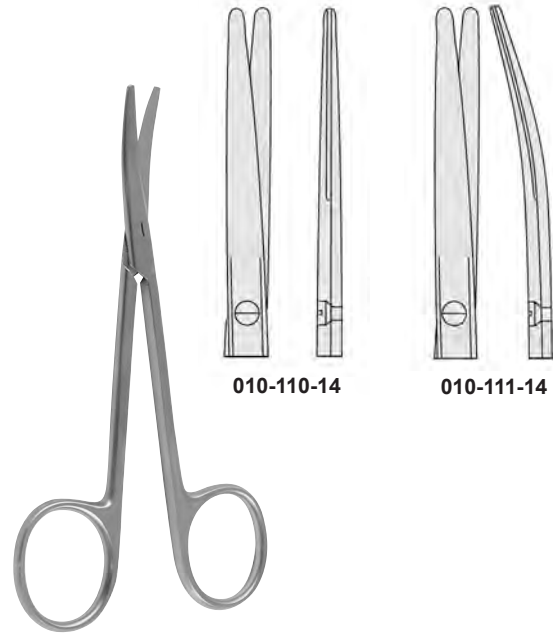
**FOMON**

13,5 cm, 5<sup>3</sup>/<sub>8</sub>" **010-009-13**



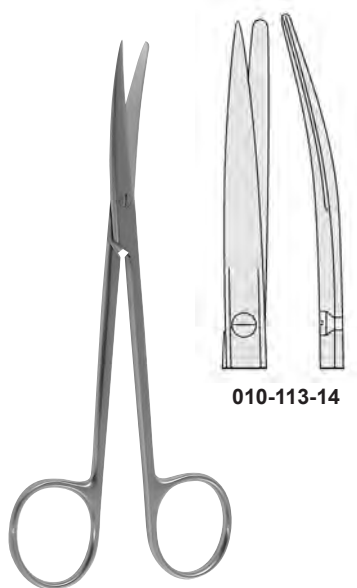
010-110-11 010-111-11

**BABY-METZENBAUM**  
11,5 cm, 4 1/2"



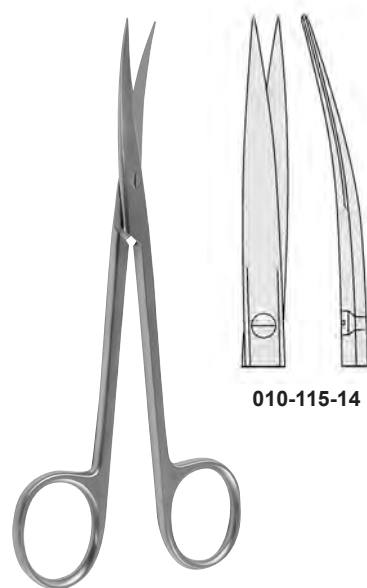
010-110-14 010-111-14

**METZENBAUM**  
14,5 cm, 5 3/4"



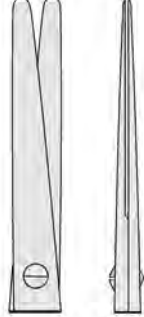
010-113-14

**METZENBAUM**  
14,5 cm, 5 3/4"



010-115-14

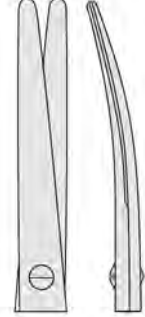
**METZENBAUM**  
14,5 cm, 5 3/4"



18,0 cm, 7"  
20,0 cm, 8"  
23,0 cm, 9"  
25,0 cm, 10"  
28,0 cm, 11"  
30,0 cm, 12"

**METZENBAUM**

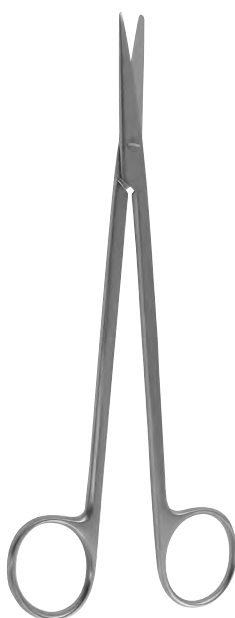
**010-110-18**  
**010-110-20**  
**010-110-23**  
**010-110-25**  
**010-110-28**  
**010-110-30**



18,0 cm, 7"  
20,0 cm, 8"  
23,0 cm, 9"  
25,0 cm, 10"  
28,0 cm, 11"  
30,0 cm, 12"

**METZENBAUM**

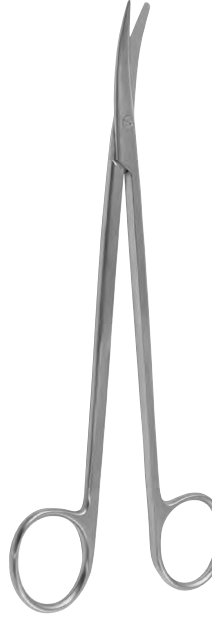
**010-111-18**  
**010-111-20**  
**010-111-23**  
**010-111-25**  
**010-111-28**  
**010-111-30**



18,0 cm, 7"  
20,0 cm, 8"  
23,0 cm, 9"  
25,0 cm, 10"  
28,0 cm, 11"  
30,0 cm, 12"

**METZENBAUM**

**010-112-18**  
**010-112-20**  
**010-112-23**  
**010-112-25**  
**010-112-28**  
**010-112-30**

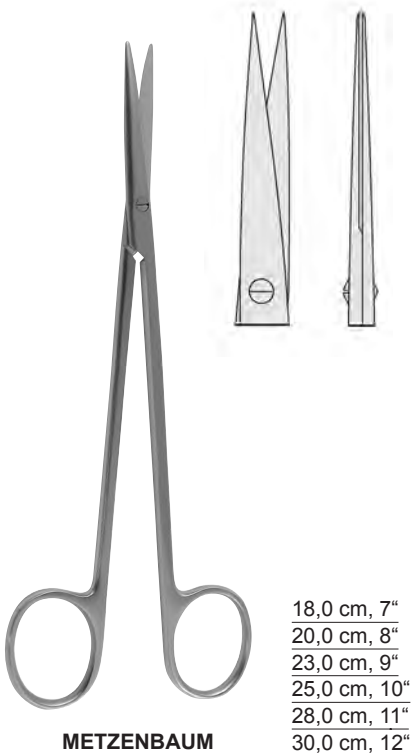


18,0 cm, 7"  
20,0 cm, 8"  
23,0 cm, 9"  
25,0 cm, 10"  
28,0 cm, 11"  
30,0 cm, 12"

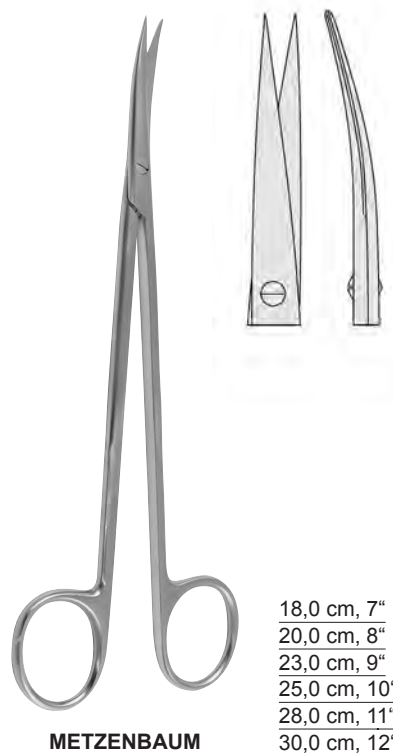
**METZENBAUM**

**010-113-18**  
**010-113-20**  
**010-113-23**  
**010-113-25**  
**010-113-28**  
**010-113-30**

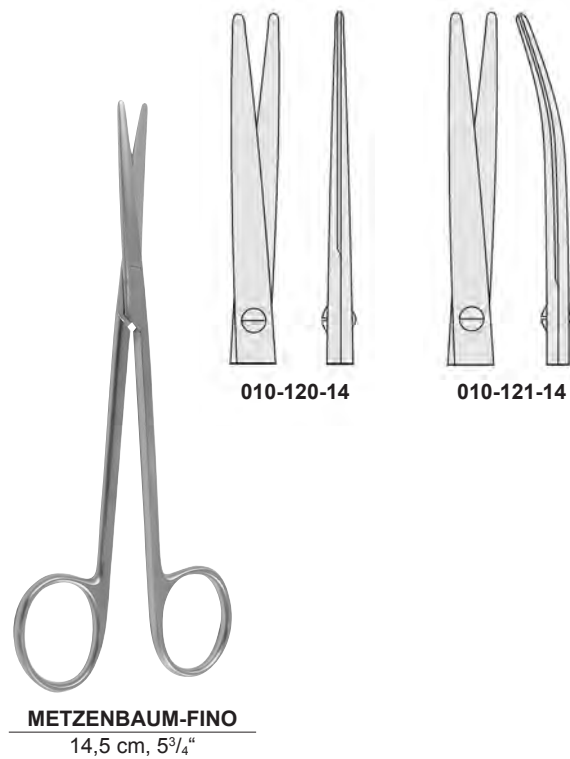
Präparierscheren  
Dissecting Scissors  
Tijeras de disección  
Forbici per dissezione



**010-114-18**  
**010-114-20**  
**010-114-23**  
**010-114-25**  
**010-114-28**  
**010-114-30**



**010-115-18**  
**010-115-20**  
**010-115-23**  
**010-115-25**  
**010-115-28**  
**010-115-30**

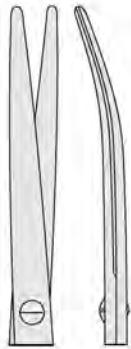
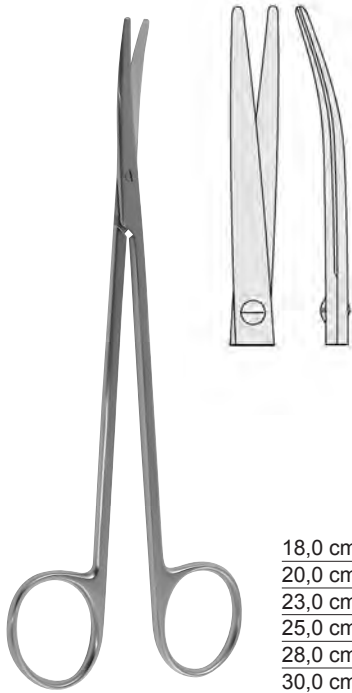


**010-120-14**

**010-121-14**



**010-120-18**  
**010-120-20**  
**010-120-23**  
**010-120-25**  
**010-120-28**  
**010-120-30**



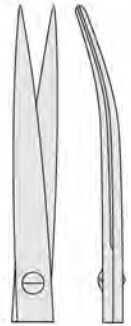
18,0 cm, 7"  
20,0 cm, 8"  
23,0 cm, 9"  
25,0 cm, 10"  
28,0 cm, 11"  
30,0 cm, 12"

**METZENBAUM-FINO**

**010-121-18**  
**010-121-20**  
**010-121-23**  
**010-121-25**  
**010-121-28**  
**010-121-30**

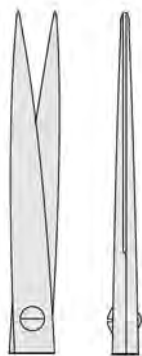


**010-124-14**



**010-125-14**

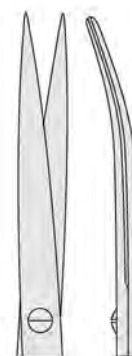
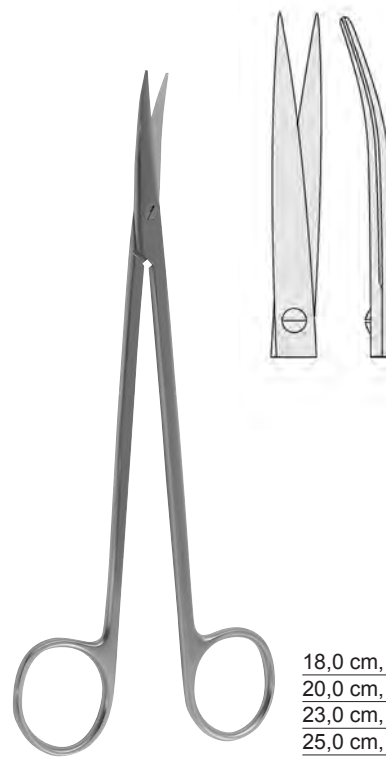
**METZENBAUM-FINO**  
14,5 cm, 5<sup>3</sup>/<sub>4</sub>"



18,0 cm, 7"  
20,0 cm, 8"  
23,0 cm, 9"  
25,0 cm, 10"  
28,0 cm, 11"  
30,0 cm, 12"

**METZENBAUM-FINO**

**010-124-18**  
**010-124-20**  
**010-124-23**  
**010-124-25**  
**010-124-28**  
**010-124-30**

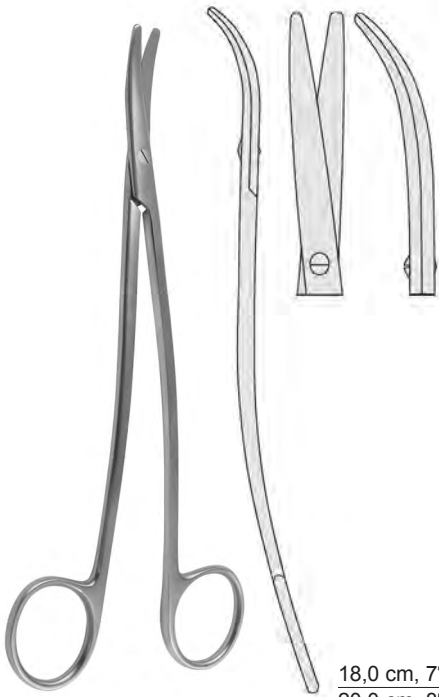


18,0 cm, 7"  
20,0 cm, 8"  
23,0 cm, 9"  
25,0 cm, 10"  
28,0 cm, 11"  
30,0 cm, 12"

**METZENBAUM-FINO**

**010-125-18**  
**010-125-20**  
**010-125-23**  
**010-125-25**  
**010-125-28**  
**010-125-30**

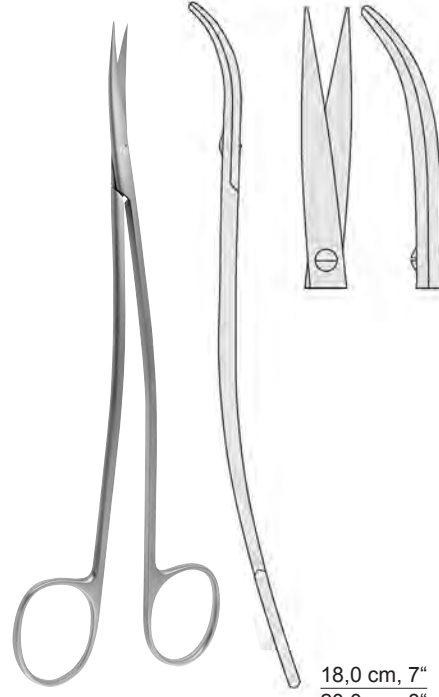




**METZENBAUM-FINO S**

18,0 cm, 7"  
 20,0 cm, 8"  
 23,0 cm, 9"

010-127-18  
 010-127-20  
 010-127-23



**METZENBAUM-FINO S**

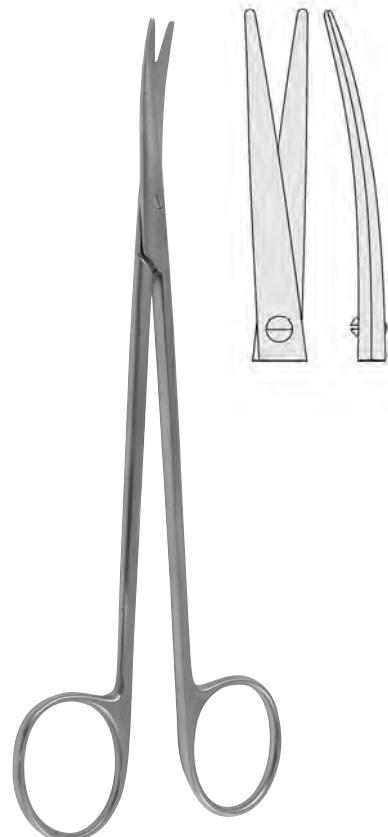
18,0 cm, 7"  
 20,0 cm, 8"  
 23,0 cm, 9"

010-129-18  
 010-129-20  
 010-129-23



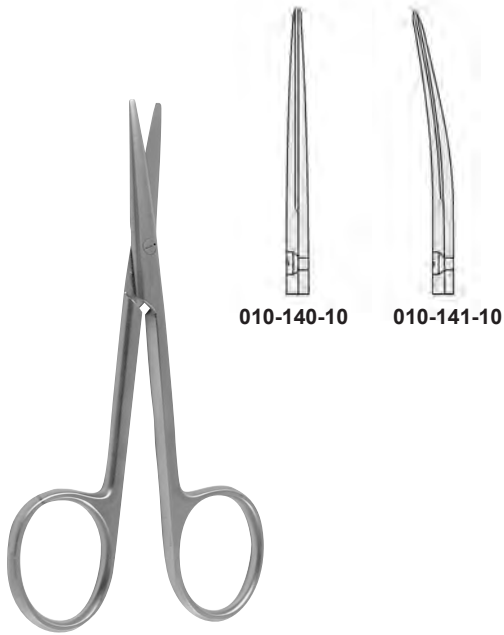
**METZENBAUM-LAHEY**

14,0 cm, 5 1/2"      010-137-14

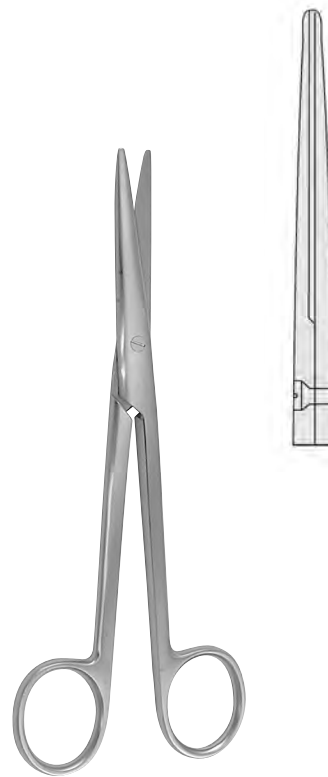


**TOENNIS-ADSON**

17,0 cm, 6 3/4"      010-139-17

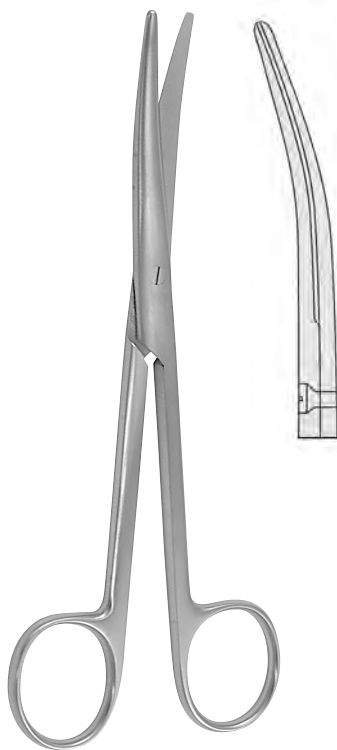


**BABY-LEXER**  
10,0 cm, 4"



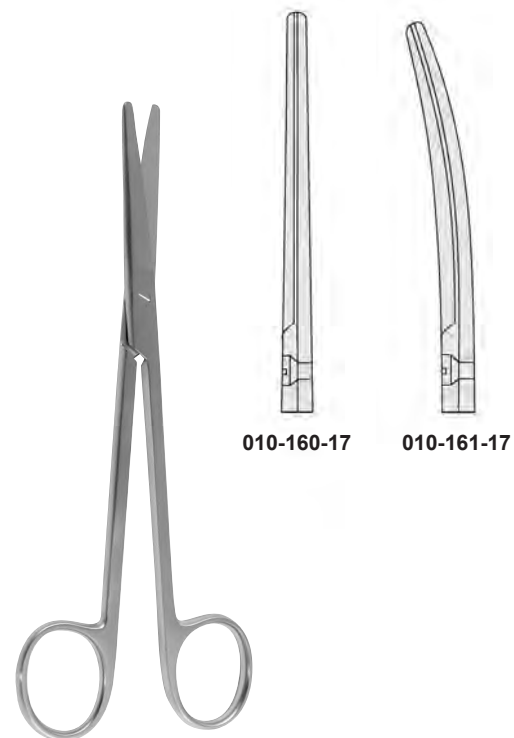
16,0 cm, 6<sup>1</sup>/<sub>4</sub>" **010-140-16**  
21,0 cm, 8<sup>1</sup>/<sub>4</sub>" **010-140-21**

**LEXER**



16,0 cm, 6<sup>1</sup>/<sub>4</sub>" **010-141-16**  
21,0 cm, 8<sup>1</sup>/<sub>4</sub>" **010-141-21**

**LEXER**



**010-160-17** **010-161-17**

**MIXTER**

17,0 cm, 6<sup>3</sup>/<sub>4</sub>"

Präparierscheren, feine chirurgische Scheren  
 Dissecting Scissors, fine surgical scissors  
 Tijeras de disección, tijeras finas para cirugía  
 Forbici per dissezione, forbici fine per chirurgia



12,0 cm, 4 <sup>3</sup> / <sub>4</sub> "	<b>010-200-12</b>
15,0 cm, 6"	<b>010-200-15</b>
18,0 cm, 7"	<b>010-200-18</b>
20,0 cm, 8"	<b>010-200-20</b>

**KILNER (RAGNELL)**



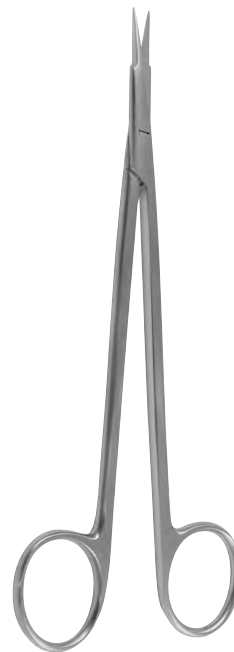
12,0 cm, 4 <sup>3</sup> / <sub>4</sub> "	<b>010-201-12</b>
15,0 cm, 6"	<b>010-201-15</b>
18,0 cm, 7"	<b>010-201-18</b>
20,0 cm, 8"	<b>010-201-20</b>

**KILNER (RAGNELL)**



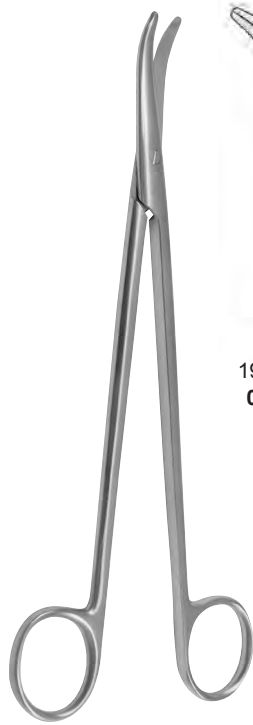
15,0 cm, 6"	<b>010-210-15</b>
18,0 cm, 7"	<b>010-210-18</b>

**REYNOLDS**

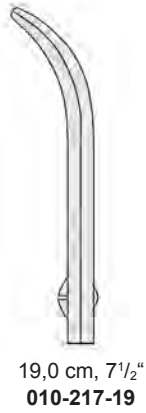


15,0 cm, 6"	<b>010-211-15</b>
18,0 cm, 7"	<b>010-211-18</b>
20,0 cm, 8"	<b>010-211-20</b>
23,0 cm, 9"	<b>010-211-23</b>
25,0 cm, 10"	<b>010-211-25</b>

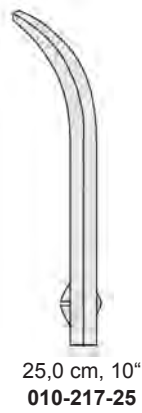
**REYNOLDS**



**THOREK**



19,0 cm, 7 1/2"  
**010-217-19**



25,0 cm, 10"  
**010-217-25**



15,0 cm, 6"



**010-220-15**

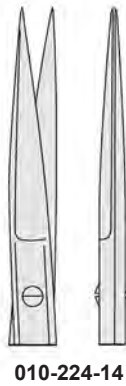


**010-221-15**

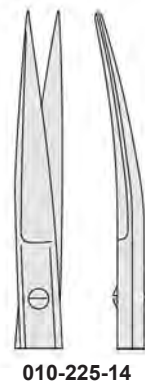
**Nerv-Präparierscheren**  
**Nerve dissecting scissors**  
**Tijeras para nervios**  
**Forbici per dissezione di nervi**



**SANVENERO**  
14,0 cm, 5 1/2"



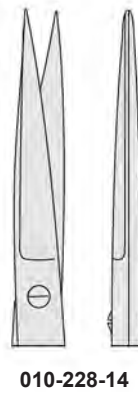
**010-224-14**



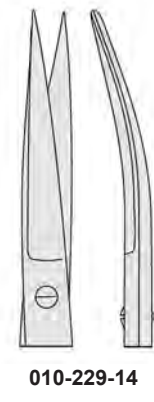
**010-225-14**



**JOSEPH**  
14,0 cm, 5 1/2"

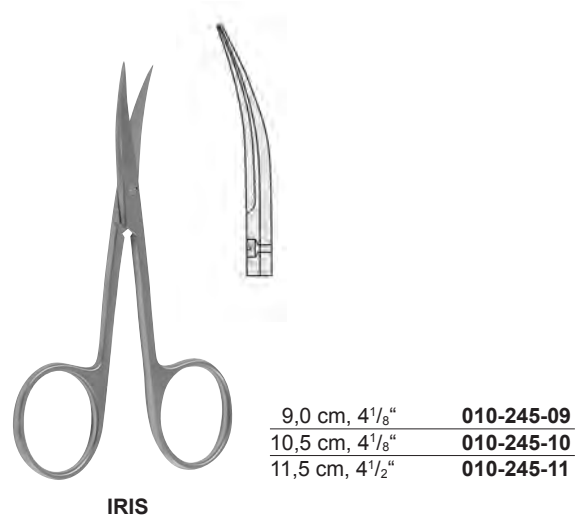
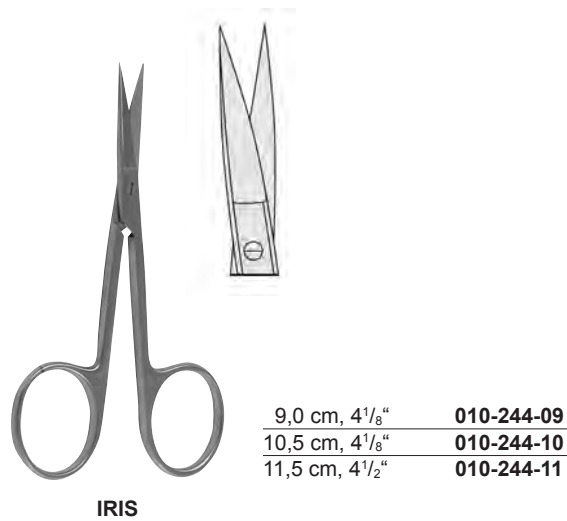


**010-228-14**



**010-229-14**

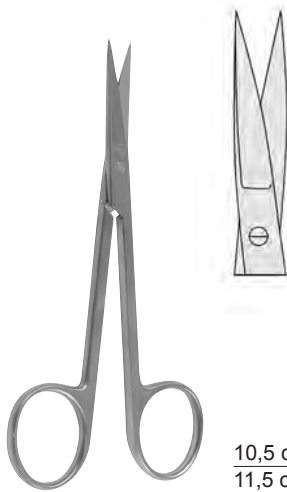
Feine chirurgische Scheren  
 Fine surgical scissors  
 Tijeras finas para cirugía  
 Forbici fine per chirurgia





**IZIAL DENTAL SURGICAL**  
Manufacturer And Exporter Of Surgical Dental & Manicure

Feine chirurgische Scheren  
Fine surgical scissors  
Tijeras finas para cirugía  
Forbici fine per chirurgia



10,5 cm, 4<sup>1</sup>/<sub>8</sub>"     **010-250-10**  
11,5 cm, 4<sup>1</sup>/<sub>2</sub>"     **010-250-11**

**IRIS**



10,5 cm, 4<sup>1</sup>/<sub>8</sub>"     **010-251-10**  
11,5 cm, 4<sup>1</sup>/<sub>2</sub>"     **010-251-11**

**IRIS**



11,5 cm, 4<sup>1</sup>/<sub>2</sub>"  
**010-261-11**



11,5 cm, 4<sup>1</sup>/<sub>2</sub>"  
**010-263-11**

Feine chirurgische Scheren  
Fine surgical scissors  
Tijeras finas para cirugía  
Forbici fine per chirurgia



12,0 cm, 4<sup>3</sup>/<sub>4</sub>"



010-264-12



010-265-12



**MOD. BONN**  
8,0 cm, 3<sup>1</sup>/<sub>4</sub>"  
010-270-08

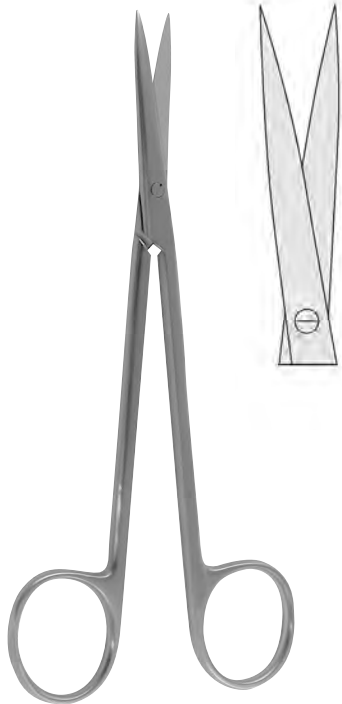


**MOD. BONN**  
8,0 cm, 3<sup>1</sup>/<sub>4</sub>"  
010-271-08

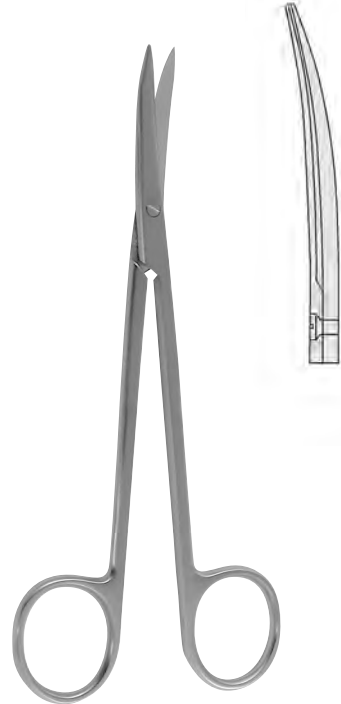


**MOD. BONN**  
8,0 cm, 3<sup>1</sup>/<sub>4</sub>"  
010-273-08





**BROPHY (SULLIVAN)**  
14,0 cm, 5 1/2"  
010-276-14



**BROPHY (SULLIVAN)**  
14,0 cm, 5 1/2"  
010-277-14



**LANDOLT**  
12,5 cm, 5"



010-280-12



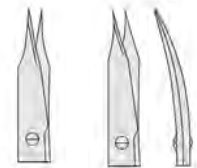
010-283-12



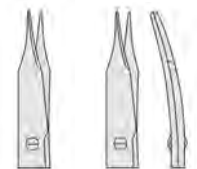
010-285-12



**STEVENS**



10,5 cm, 4 1/8" 010-290-10 010-291-10  
11,5 cm, 4 1/2" 010-290-11 010-291-11



10,5 cm, 4 1/8" 010-294-10 010-295-10  
11,5 cm, 4 1/2" 010-294-11 010-295-11





Inzisionsscheren  
 Incision scissors  
 Tijeras para incisión  
 Forbici vascolare e per fistole

13,0 cm, 5"  
 14,5 cm, 5<sup>3</sup>/<sub>4</sub>"

**010-300-13**  
**010-300-14**

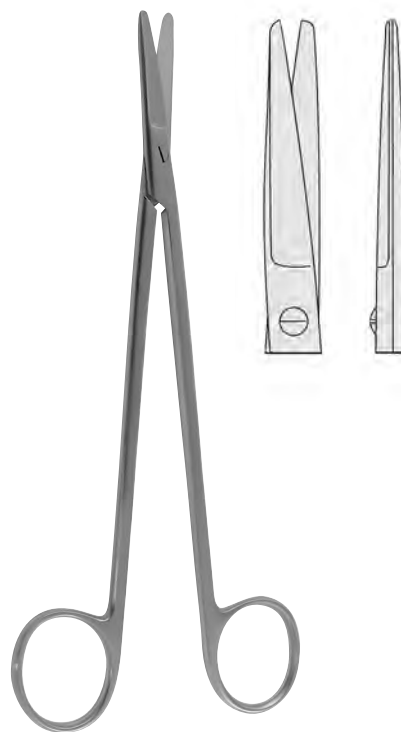


**RICHTER**  
 14,5 cm, 5<sup>3</sup>/<sub>4</sub>"  
**010-310-14**

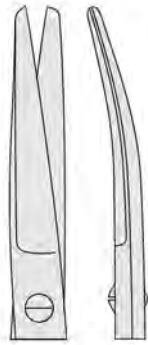


**FERGUSSON**  
 16,5 cm, 6<sup>1</sup>/<sub>4</sub>"  
 18,0 cm, 7"

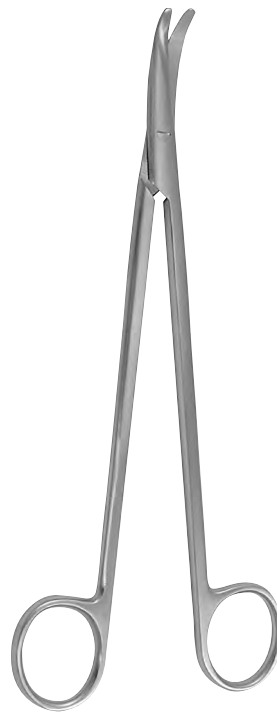
**010-315-16**  
**010-315-18**



**TOENNIS**  
 18,0 cm, 7"  
**010-324-18**



**TOENNIS**  
 18,0 cm, 7"  
 010-325-18



**HALLE**  
 19,0 cm, 7 1/2"  
 010-341-19



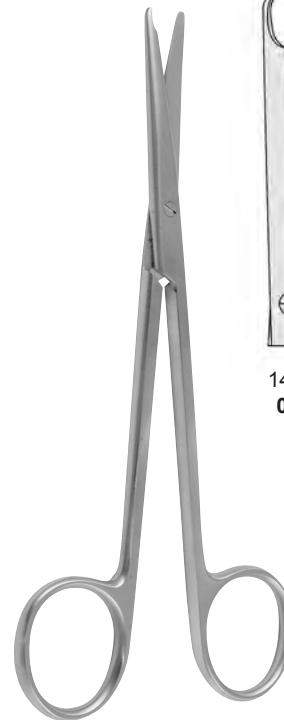
**FOMON**  
 15,0 cm, 6"  
 010-343-15



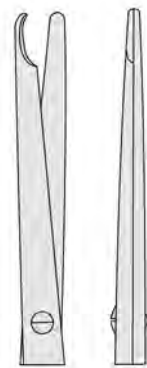
**SPENCER**  
 9,0 cm, 4 1/8"    **010-400-09**  
 10,5 cm, 4 1/8"    **010-400-10**  
 13,0 cm, 5"    **010-400-13**



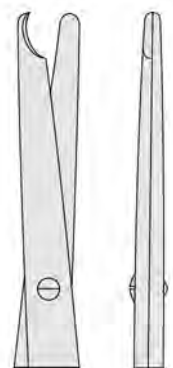
**LITTAUER**  
 11,5 cm, 4 1/4"    **010-402-11**  
 14,0 cm, 5 1/2"    **010-402-14**



**BUCK**

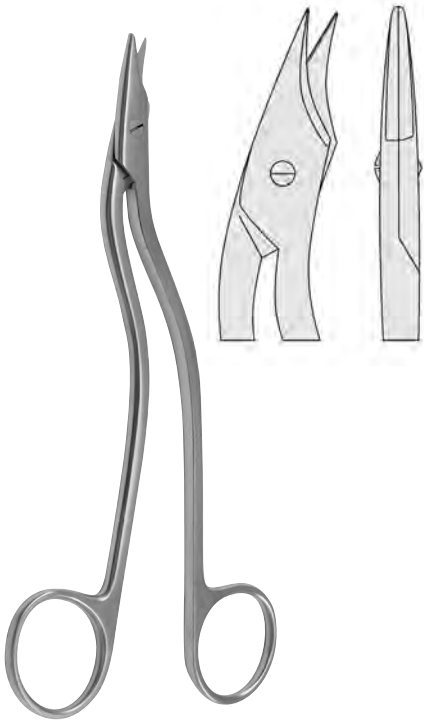


14,5 cm, 5 3/4"  
**010-404-14**



18,0 cm, 7"  
**010-404-18**

Ligaturscheren, Neurochirurgische Scheren  
 Ligature Scissors, Neurosurgical Scissors  
 Tijeras para ligaduras, Tijeras para Neurocirugía  
 Forbici per legature, Forbici per Neurochirurgia



**HEATH**  
 16,0 cm, 6<sup>1</sup>/<sub>4</sub>"  
 010-408-16



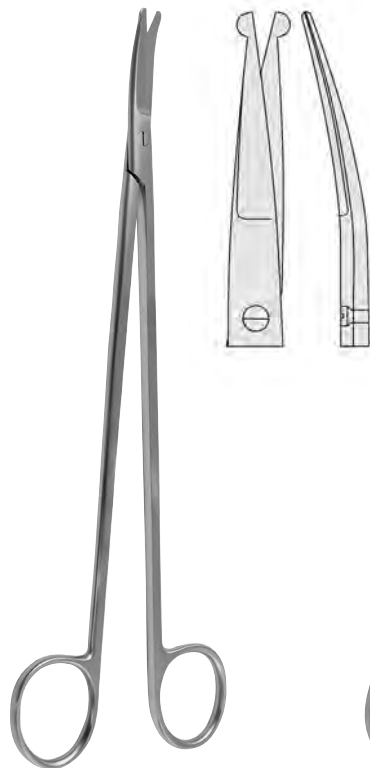
**NORTHBENT**  
 9,0 cm, 3<sup>1</sup>/<sub>2</sub>"  
 010-411-19



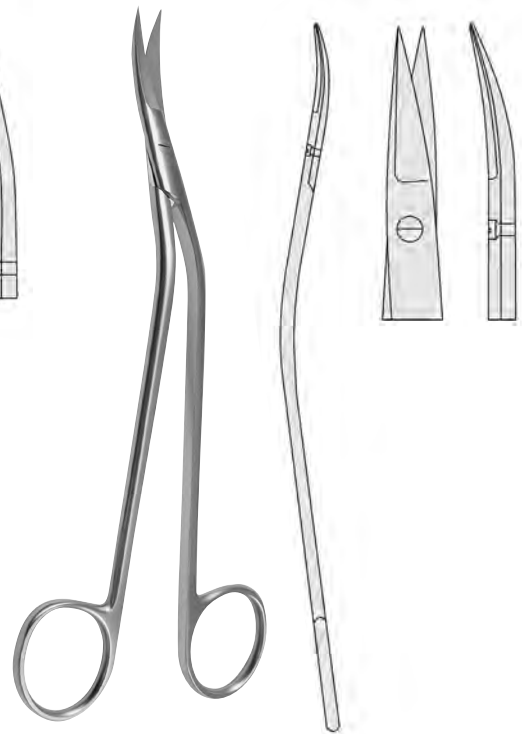
**NORTHBENT**  
 13,0 cm, 5"  
 010-413-13



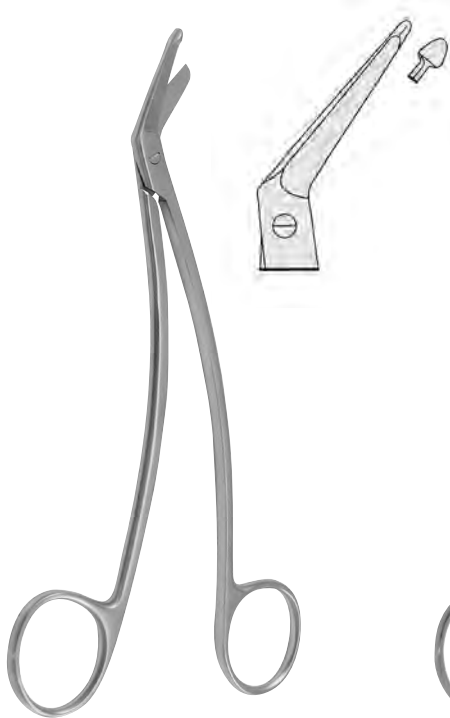
**EISELSBERG**  
 12,0 cm, 4<sup>3</sup>/<sub>4</sub>"  
 010-415-12



**STRULLY**  
 22,0 cm, 8<sup>5</sup>/<sub>8</sub>"  
 010-450-22



**DANDY**  
 17,0 cm, 6<sup>3</sup>/<sub>4</sub>"  
 010-453-17



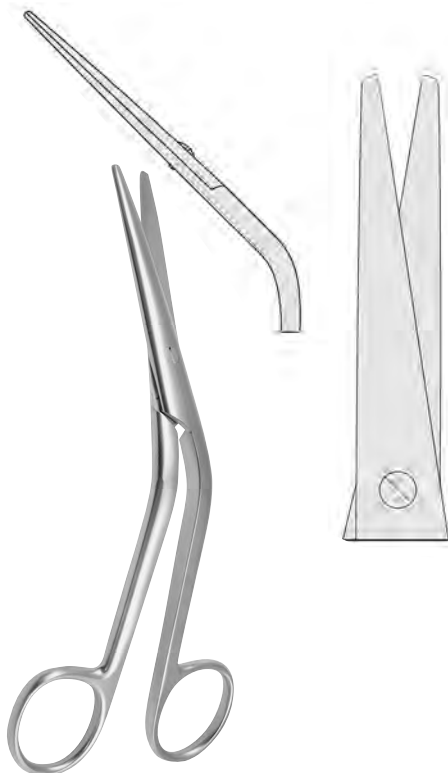
**SCHMIEDEN-TAYLOR**  
17,0 cm, 6<sup>3</sup>/<sub>4</sub>"  
010-457-17



**LINCOLN**  
17,0 cm, 6<sup>3</sup>/<sub>4</sub>"



**HEYMANN**  
18,0 cm, 7"  
010-501-18



**COTTLE**  
16,0 cm, 6<sup>1</sup>/<sub>4</sub>"  
010-511-16

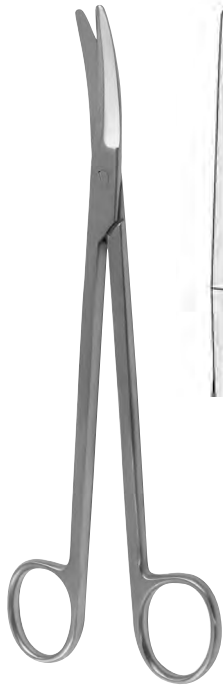


**KIRSTEN**  
18,0 cm, 7"  
010-517-18

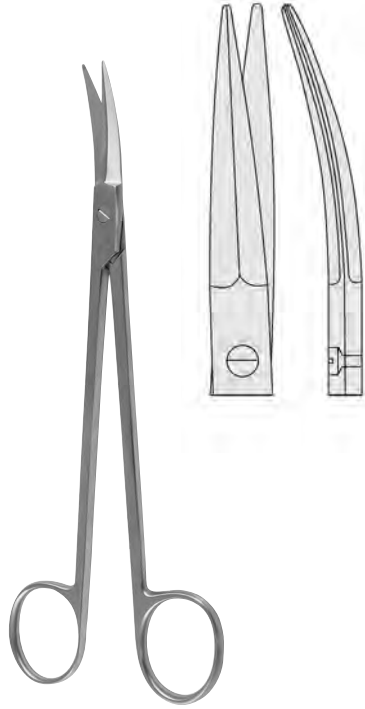


**CAPLAN**  
22,0 cm, 8<sup>5</sup>/<sub>8</sub>"  
010-519-22

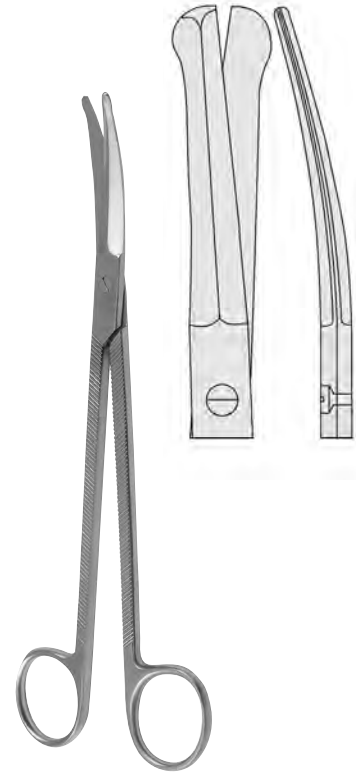
Tonsillenscheren, Nasenscheren, Gefäßscheren  
 Tonsil Scissors, Nasal Scissors, Vascular Scissors  
 Tijeras para amígdalas, Tijeras para el tabique nasal, Tijeras vasculares  
 Forbici per tonsille, Forbici per il setto nasale, Forbici vascolari



**BOETTCHER**  
 18,0 cm, 7"  
 010-521-18



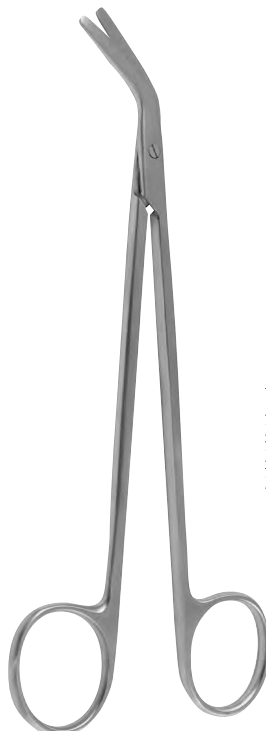
**PRINCE**  
 17,5 cm, 6<sup>5</sup>/<sub>8</sub>"  
 010-523-17



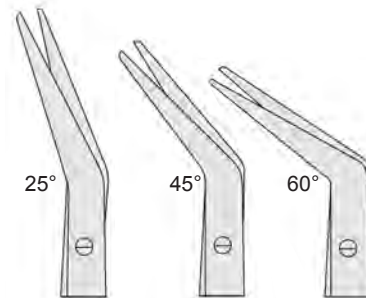
**GOOD**  
 19,0 cm, 7<sup>1</sup>/<sub>2</sub>"  
 010-525-19



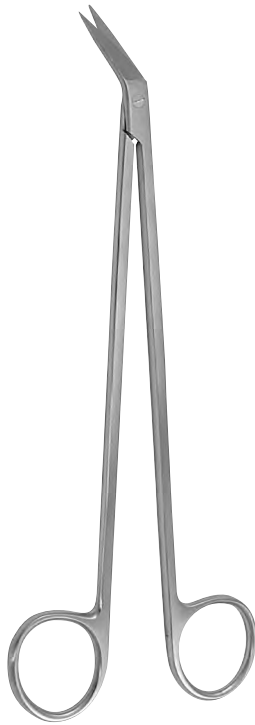
**CARTILAGE**  
 20,0 cm, 8"  
 010-528-20



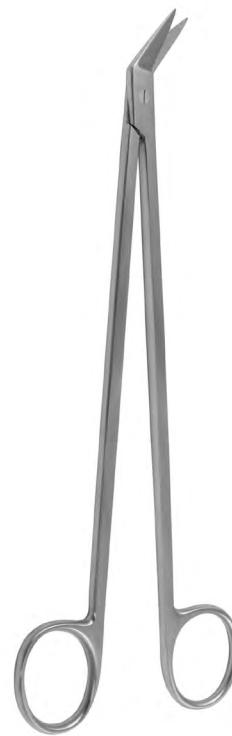
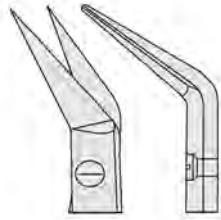
**DE BAKEY**



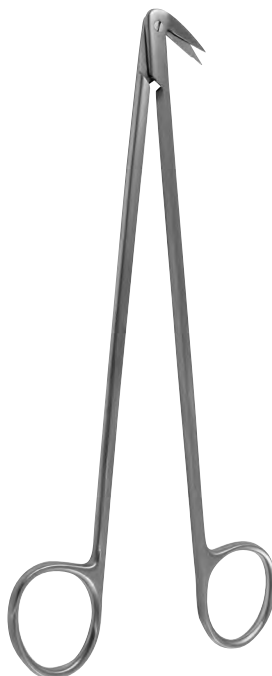
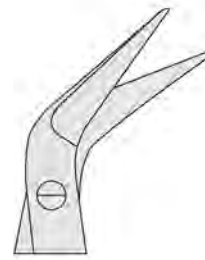
17,5 cm, 6 <sup>5</sup> / <sub>8</sub> "	010-540-25	010-540-45	010-540-60
19,5 cm, 7 <sup>3</sup> / <sub>4</sub> "	010-541-25	010-541-45	010-541-60
21,0 cm, 8 <sup>1</sup> / <sub>4</sub> "	010-542-25	010-542-45	010-542-60
23,0 cm, 9"	010-543-25	010-543-45	010-543-60
28,0 cm, 11"	010-544-25	010-544-45	010-544-60



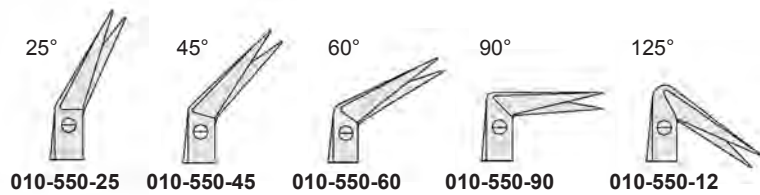
**POTTS-SMITH**  
18,0 cm, 7"  
010-547-18



**POTTS DE MARTEL**  
21,0 cm, 8 1/4" 010-548-21  
24,0 cm, 9 1/2" 010-548-24



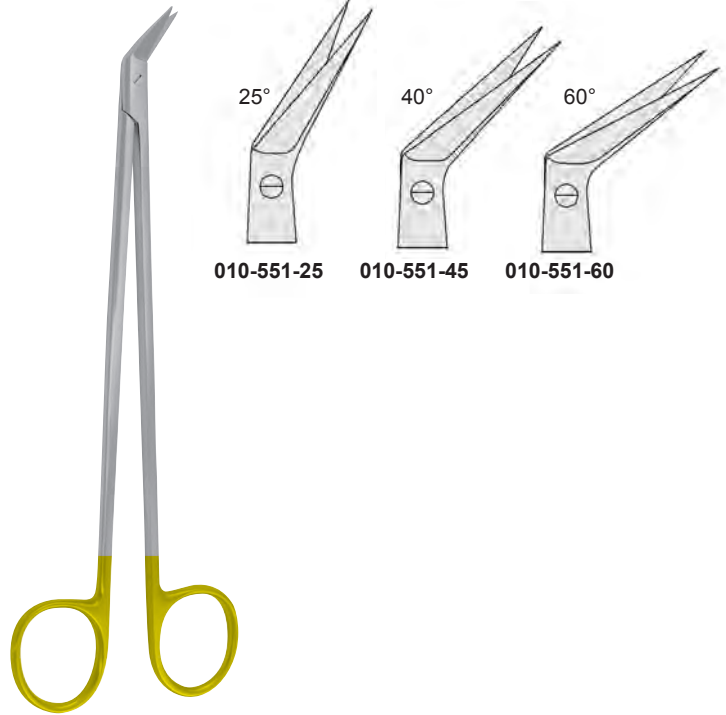
**DIETRICH-HEGEMANN**  
19,0 cm, 7 1/2"



Gefäßscheren  
 Vascular Scissors  
 Tijeras vasculares  
 Forbici vascolari

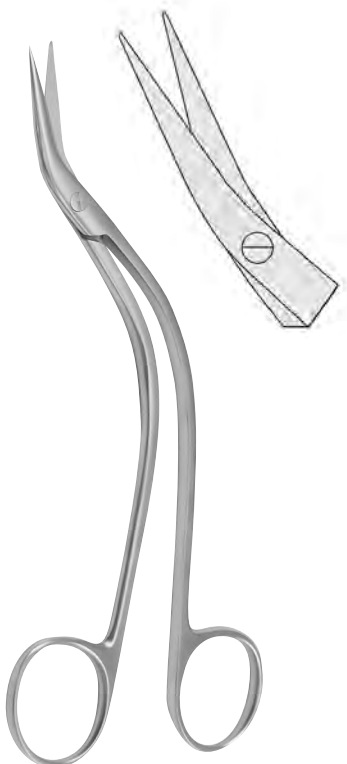


**DIETRICH**  
 20,0 cm, 7 1/2"  
 010-552-12

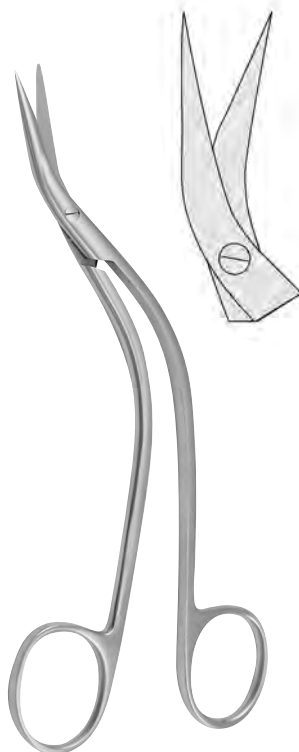


**POTTS-SMITH**  
 19,0 cm, 7 1/2"

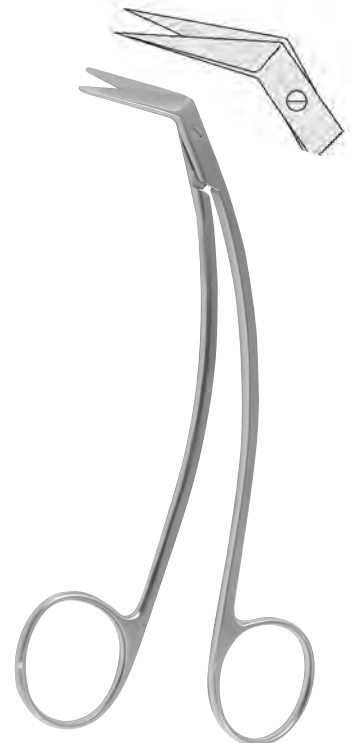
25° 010-551-25  
 40° 010-551-45  
 60° 010-551-60



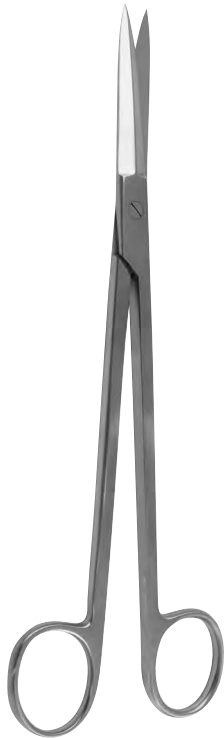
**DE BAKEY**  
 15,5 cm, 6"  
 010-560-15



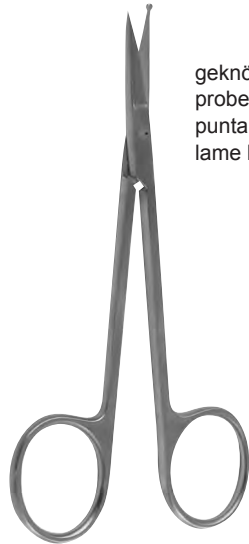
**DE BAKEY**  
 15,5 cm, 6"  
 010-561-15



**DE BAKEY**  
 15,5 cm, 6"  
 010-562-15



**MC INDOE**  
19,0 cm, 7 1/2"  
010-570-19



geknöpftes Blatt  
probe-pointed blade  
punta botonda  
lame bottonuta

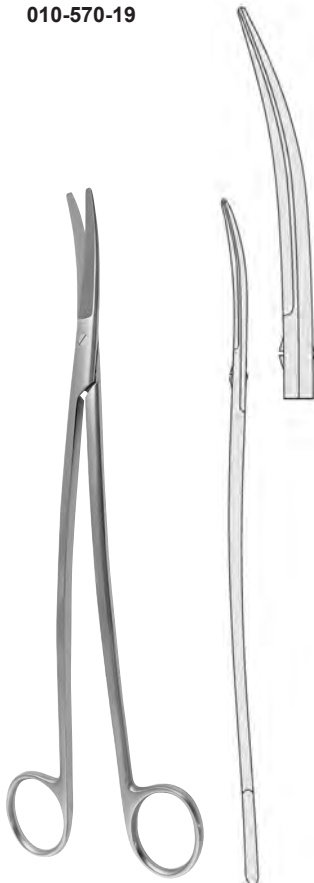
11,5 cm, 4 1/2"  
010-572-11



**CRAFOORD**  
30,0 cm, 12"  
010-575-30



**SATINSKY**  
15,5 cm, 9 5/8"  
010-577-24



**KLINGENBERG-LOTH**  
23,0 cm, 9"  
010-579-23



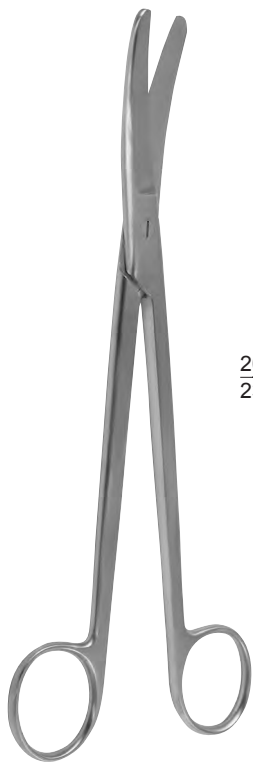
**SIMS**



20,0 cm, 8"    010-600-20    010-602-20    010-604-20  
23,0 cm, 9"    010-600-23    010-602-23    010-604-23

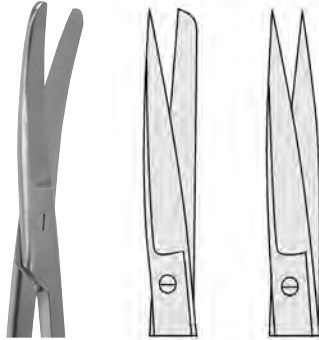


Gynäkologische Scheren  
 Gynecology scissors  
 Tijeras para ginecología  
 Forbici per ginecologia



**SIMS**

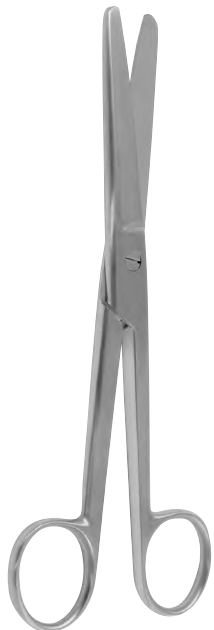
20,0 cm, 8"	<b>010-601-20</b>	<b>010-603-20</b>	<b>010-605-20</b>
23,0 cm, 9"	<b>010-601-23</b>	<b>010-603-23</b>	<b>010-605-23</b>



**SIEBOLD**  
 24,0 cm, 9 1/2"  
**010-620-24**

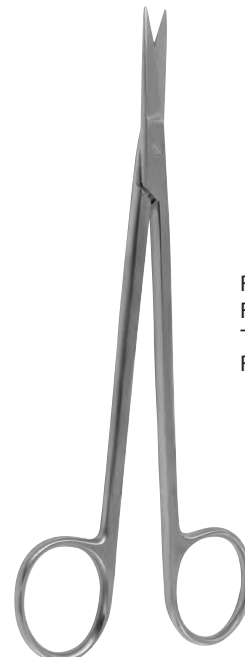
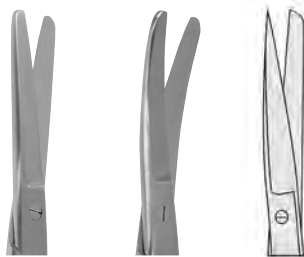


**BOZEMANN**  
 22,0 cm, 8 3/4"  
**010-622-22**



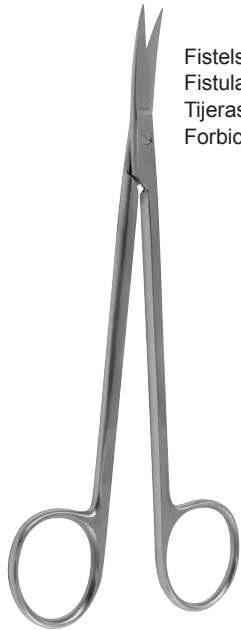
**DOYEN**

16,0 cm, 6 1/4"	<b>010-610-16</b>	<b>010-611-16</b>	<b>010-612-16</b>
17,5 cm, 6 5/8"	<b>010-610-17</b>	<b>010-611-17</b>	



**KELLY**  
 16,0 cm, 6 1/4" **010-634-16**  
 18,0 cm, 7" **010-634-18**

Fistelscheren  
 Fistula scissors  
 Tijeras para fistulas  
 Forbici per fistole



Fistelscheren  
 Fistula scissors  
 Tijeras para fistulas  
 Forbici per fistole

**KELLY**

16,0 cm, 6<sup>1</sup>/<sub>4</sub>"      **010-635-16**  
 18,0 cm, 7"        **010-635-18**



**WERTHEIM**

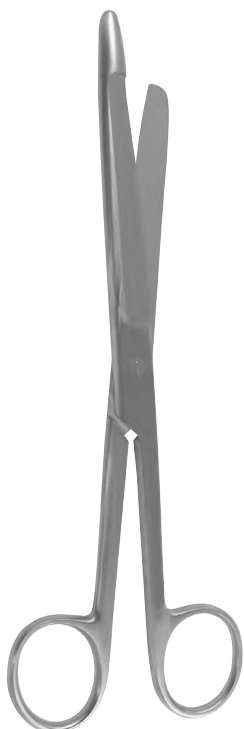
19,5 cm, 7<sup>3</sup>/<sub>4</sub>"      **010-640-19**  
 22,5 cm, 8<sup>3</sup>/<sub>4</sub>"      **010-640-23**



**010-651-18**

**DUBOIS**

27,0 cm, 10<sup>5</sup>/<sub>8</sub>"  
**010-650-18**



21,0 cm, 8<sup>1</sup>/<sub>4</sub>"  
**010-670-21**



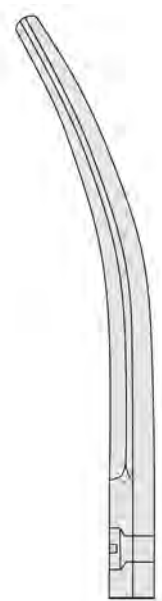
21,0 cm, 8<sup>1</sup>/<sub>4</sub>"  
**010-672-21**



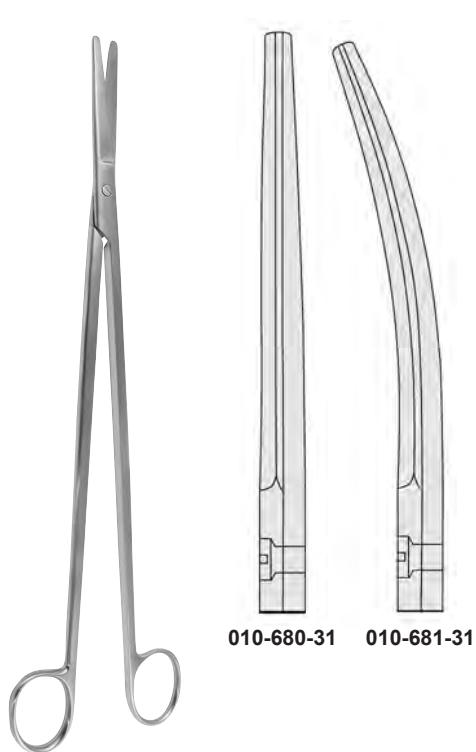
21,0 cm, 8<sup>1</sup>/<sub>4</sub>"  
**010-674-21**



**LLOYD-DAVIES**  
 27,0 cm, 10<sup>5</sup>/<sub>8</sub>"  
**010-677-27**

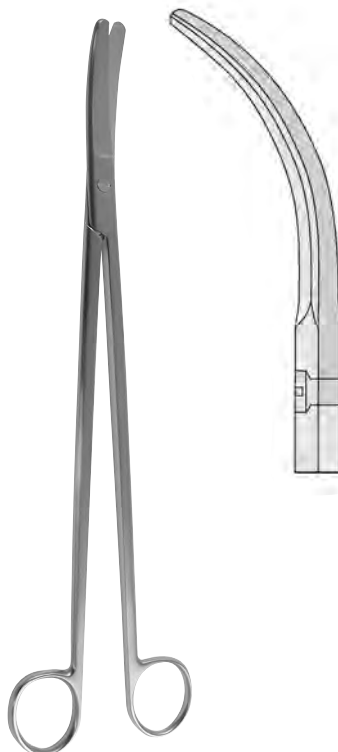


Lungenlappen- und Rektumscheren, Lungenscheren, Dammscheren  
 Lobectomy and Rectal Scissors, Lobectomy Scissors, Episiotomy Scissors  
 Tijeras para lobectomía y recto, Tijera para lobectomía, Tijeras para episiotomía  
 Forbici per lobo polmonare e per il retto, Forbici per lobo, Forbici per episiotomia



**STELZNER**  
 31,0 cm, 12<sup>1</sup>/<sub>4</sub>"

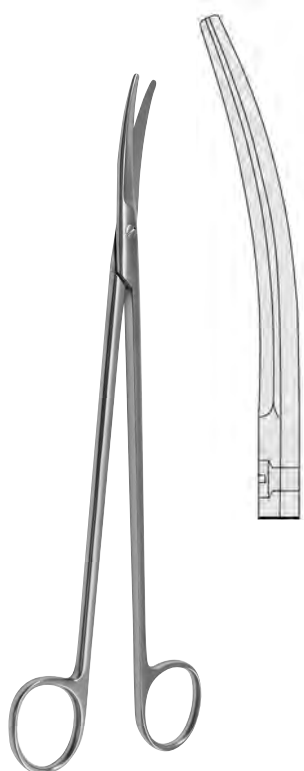
010-680-31 010-681-31



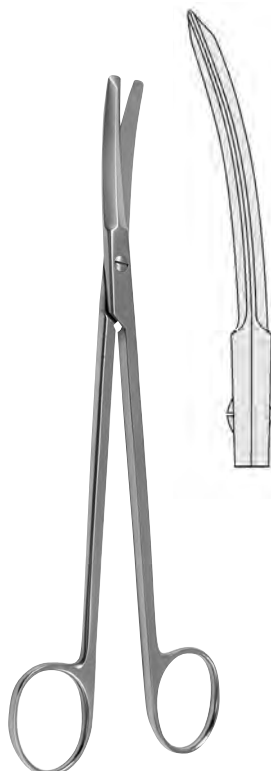
**RECTAL**  
 32,5 cm, 12<sup>3</sup>/<sub>4</sub>"  
 010-685-32



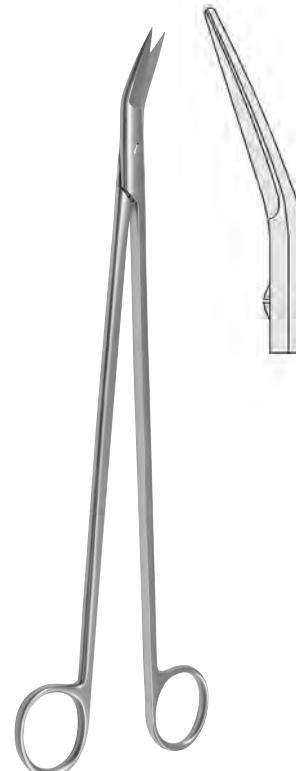
**WILLAUER**  
 25,0 cm, 9<sup>3</sup>/<sub>4</sub>" 010-688-25  
 28,0 cm, 11" 010-688-28



**WILLAUER**  
 25,0 cm, 9<sup>3</sup>/<sub>4</sub>" 010-689-25  
 28,0 cm, 11" 010-689-28



**POTTS-SMITH**  
 19,0 cm, 7<sup>1</sup>/<sub>2</sub>"  
 010-691-19



**FINOCHIETTO**  
 32,5 cm, 10<sup>5</sup>/<sub>8</sub>"  
 010-693-27



**IZIAL DENTAL SURGICAL**

Manufacturer And Exporter Of Surgical Dental & Manicure

Lungenscheren, Dammscheren, Nabelschnurscheren  
Lobectomy Scissors, Episiotomy Scissors, Umbilical Cord Scissors  
Tijera para lobectomía, Tijeras para episiotomía, Tijeras umbilicales  
Forbici per lobo, Forbici per episiotomia, Forbici ombelicali



**WALDMANN**  
18,0 cm, 7"  
010-695-18



**BRAUN-STADLER**  
14,5 cm, 5<sup>3</sup>/<sub>4</sub>" 010-701-14  
20,0 cm, 8" 010-701-20



20,0 cm, 8"  
010-703-20



**MOD. USA**  
10,5 cm, 4<sup>1</sup>/<sub>8</sub>"  
010-706-10



**BUSCH**  
13,5 cm, 5<sup>3</sup>/<sub>8</sub>" 010-707-13  
16,0 cm, 6<sup>1</sup>/<sub>4</sub>" 010-707-16



**SCHUMACHER**  
16,0 cm, 16<sup>1</sup>/<sub>4</sub>"  
010-709-16

Drahtscheren, Verband- und Kleiderstoffscheren  
 Wire Scissors, Bandage and Cloth Scissors  
 Cizallas corta-alambres, Tijeras para vendajes y tela  
 Forbici taglia cavo, Forbici per bendaggi e vestiti



gezahnt  
 serrated  
 dentada  
 dentata

**UNIVERSAL**  
 12,0 cm, 4<sup>3</sup>/<sub>4</sub>"  
 010-800-12



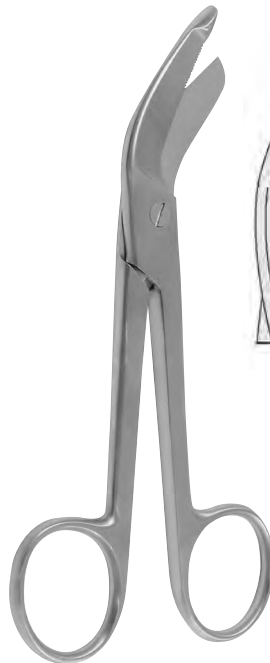
**LISTER**

9,0 cm, 3 <sup>1</sup> / <sub>2</sub> "	<b>010-900-09</b>
11,0 cm, 4 <sup>3</sup> / <sub>8</sub> "	<b>010-900-11</b>
14,0 cm, 5 <sup>1</sup> / <sub>2</sub> "	<b>010-900-14</b>
18,0 cm, 7"	<b>010-900-18</b>
20,0 cm, 8"	<b>010-900-20</b>



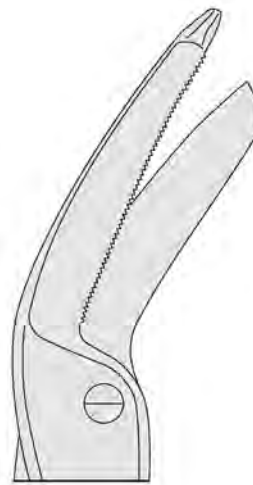
**LISTER**

18,5 cm, 7 <sup>1</sup> / <sub>4</sub> "	<b>010-901-18</b>
21,0 cm, 8 <sup>1</sup> / <sub>4</sub> "	<b>010-901-21</b>



**LISTER-EXCENTRIC**

16,0 cm, 6 <sup>1</sup> / <sub>4</sub> "	<b>010-903-16</b>
19,0 cm, 7 <sup>1</sup> / <sub>2</sub> "	<b>010-903-19</b>



gezahnt  
 serrated  
 dentada  
 dentata



**BERGMANN**

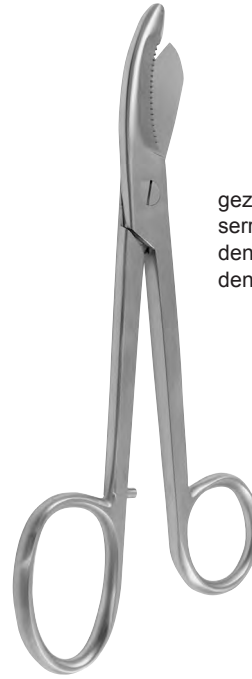
23,0 cm, 9"	<b>010-905-23</b>
-------------	-------------------



**ESMARCH**  
20,0 cm, 8" **010-907-20**  
22,0 cm, 8<sup>5</sup>/<sub>8</sub>" **010-907-22**

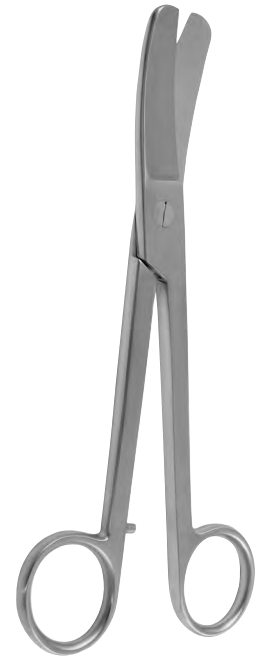


**KNOWLES**  
14,0 cm, 5<sup>1</sup>/<sub>2</sub>"  
**010-920-14**



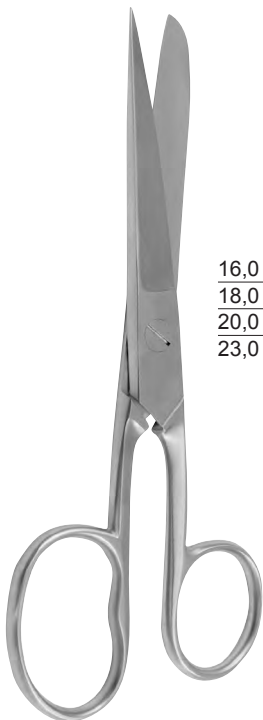
gezahnt  
serrated  
dentada  
dentata

**BRUNS**  
24,0 cm, 9<sup>1</sup>/<sub>2</sub>"  
**010-909-24**  
**010-910-24**



**LORENZ**  
23,0 cm, 9"  
**010-930-23**

bis 134°C autoklavierbar  
autoclavable up to 134°C  
esterilizable en autoclave hasta 134°C  
Sterilizzabile in autoclave fino 134°C



**SMITH**  
**(MOD. USA)**

16,0 cm, 6<sup>1</sup>/<sub>4</sub>" **010-940-16**  
18,0 cm, 7" **010-940-18**  
20,0 cm, 8" **010-940-20**  
23,0 cm, 9" **010-940-23**



gezahnt  
serrated  
dentada  
dentata

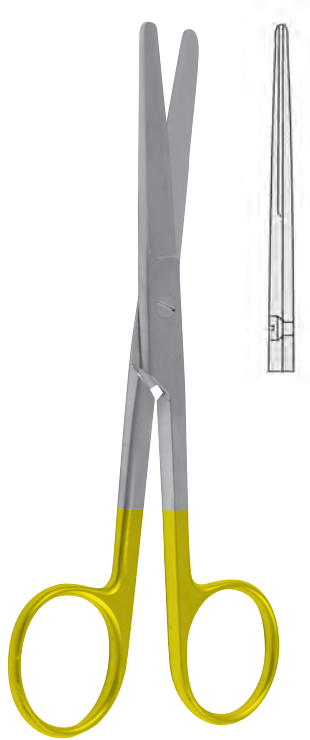
20,0 cm, 8"  
**010-941-20**



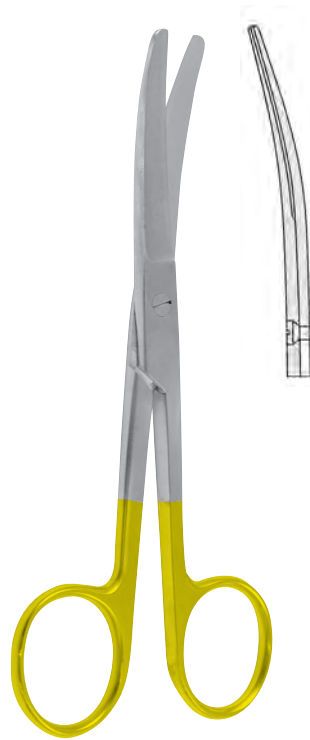
gezahnt  
serrated  
dentada  
dentata

**UNIVERSAL**  
14,0 cm, 5<sup>1</sup>/<sub>2</sub>" **010-950-14**  
16,0 cm, 6<sup>1</sup>/<sub>4</sub>" **010-950-16**  
18,0 cm, 7" **010-950-18**

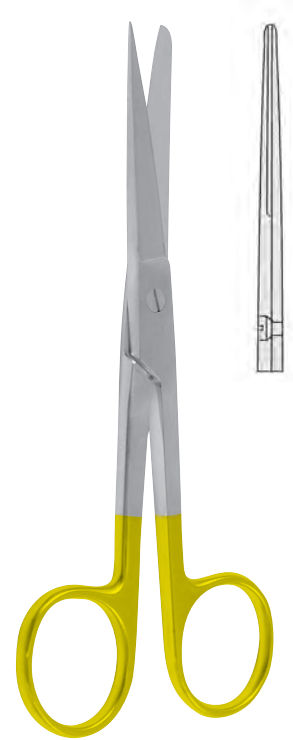
Chirurgische Scheren mit Hartmetallschneiden  
 Surgical Scissors with tungsten carbide edges  
 Tijeras para cirugía con filos de carburo tungsteno  
 Forbici per chirurgia con lame in carburo di tungsteno



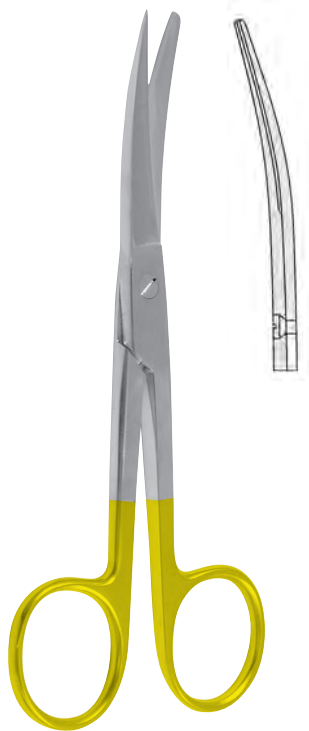
**STANDARD**  
 14,5 cm, 5<sup>3</sup>/<sub>4</sub>"    **011-000-14**  
 16,5 cm, 6<sup>1</sup>/<sub>2</sub>"    **011-000-16**  
 18,5 cm, 7<sup>1</sup>/<sub>4</sub>"    **011-000-18**



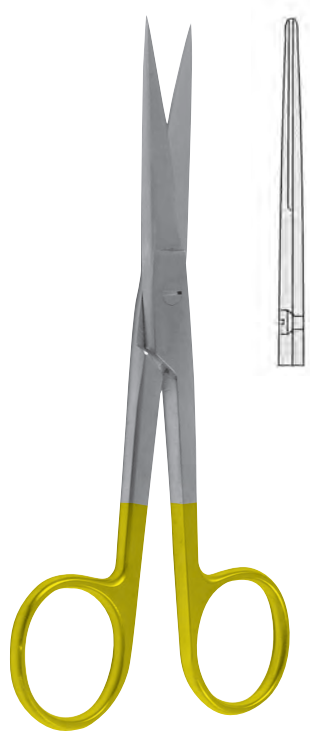
**STANDARD**  
 14,5 cm, 5<sup>3</sup>/<sub>4</sub>"    **011-001-14**  
 16,5 cm, 6<sup>1</sup>/<sub>2</sub>"    **011-001-16**  
 18,5 cm, 7<sup>1</sup>/<sub>4</sub>"    **011-001-18**



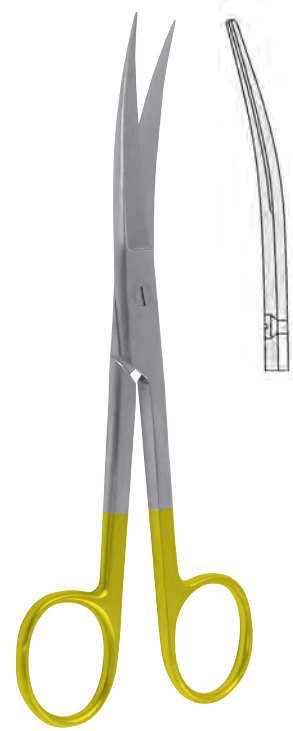
**STANDARD**  
 14,5 cm, 5<sup>3</sup>/<sub>4</sub>"    **011-002-14**  
 16,5 cm, 6<sup>1</sup>/<sub>2</sub>"    **011-002-16**  
 18,5 cm, 7<sup>1</sup>/<sub>4</sub>"    **011-002-18**



**STANDARD**  
 14,5 cm, 5<sup>3</sup>/<sub>4</sub>"    **011-003-14**  
 16,5 cm, 6<sup>1</sup>/<sub>2</sub>"    **011-003-16**  
 18,5 cm, 7<sup>1</sup>/<sub>4</sub>"    **011-003-18**



**STANDARD**  
 14,5 cm, 5<sup>3</sup>/<sub>4</sub>"    **011-004-14**  
 16,5 cm, 6<sup>1</sup>/<sub>2</sub>"    **011-004-16**  
 18,5 cm, 7<sup>1</sup>/<sub>4</sub>"    **011-004-18**



**STANDARD**  
 14,5 cm, 5<sup>3</sup>/<sub>4</sub>"    **011-005-14**  
 16,5 cm, 6<sup>1</sup>/<sub>2</sub>"    **011-005-16**  
 18,5 cm, 7<sup>1</sup>/<sub>4</sub>"    **011-005-18**



**IZIAL DENTAL SURGICAL**

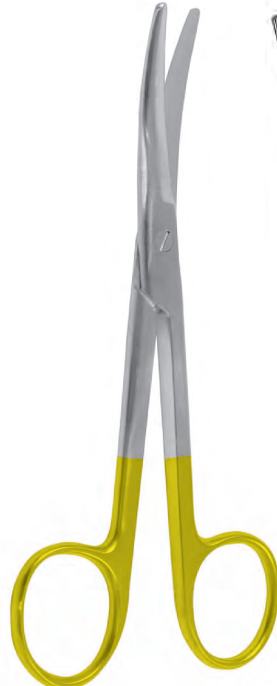
Manufacturer And Exporter Of Surgical Dental & Manicure

Chirurgische Scheren mit Hartmetallschneiden  
Surgical Scissors with tungsten carbide edges  
Tijeras para cirugía con filos de carburo tungsteno  
Forbici per chirurgia con lame in carburo di tungsteno



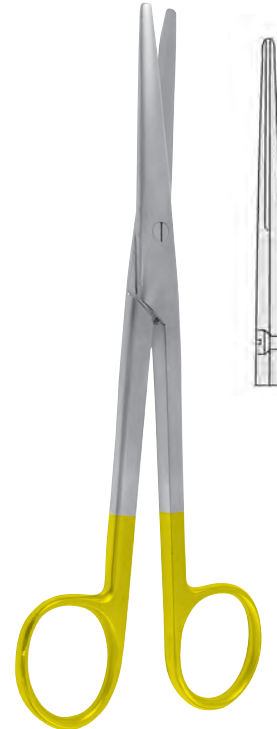
**MAYO**

14,5 cm, 5 <sup>3</sup> / <sub>4</sub> "	<b>011-100-14</b>
17,0 cm, 6 <sup>3</sup> / <sub>4</sub> "	<b>011-100-17</b>
23,0 cm, 9"	<b>011-100-23</b>



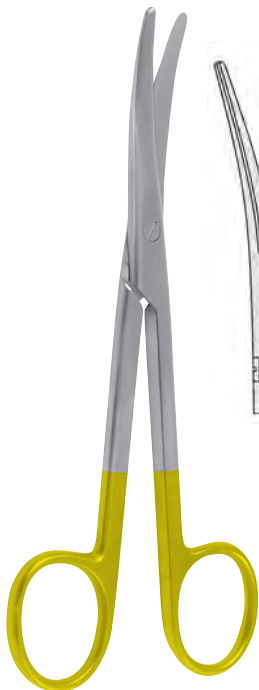
**MAYO**

14,5 cm, 5 <sup>3</sup> / <sub>4</sub> "	<b>011-101-14</b>
17,0 cm, 6 <sup>3</sup> / <sub>4</sub> "	<b>011-101-17</b>
23,0 cm, 9"	<b>011-101-23</b>



**MAYO-STILLE**

15,0 cm, 6"	<b>011-102-15</b>
17,0 cm, 6 <sup>3</sup> / <sub>4</sub> "	<b>011-102-17</b>



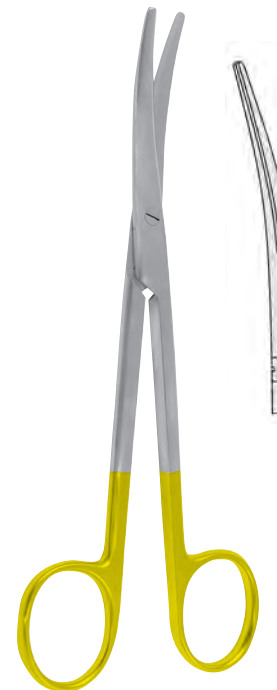
**MAYO-STILLE**

15,0 cm, 6"	<b>011-103-15</b>
17,0 cm, 6 <sup>3</sup> / <sub>4</sub> "	<b>011-103-17</b>



**LEXER**

16,0 cm, 6 <sup>1</sup> / <sub>4</sub> "	<b>011-140-16</b>
21,0 cm, 8 <sup>1</sup> / <sub>4</sub> "	<b>011-140-21</b>

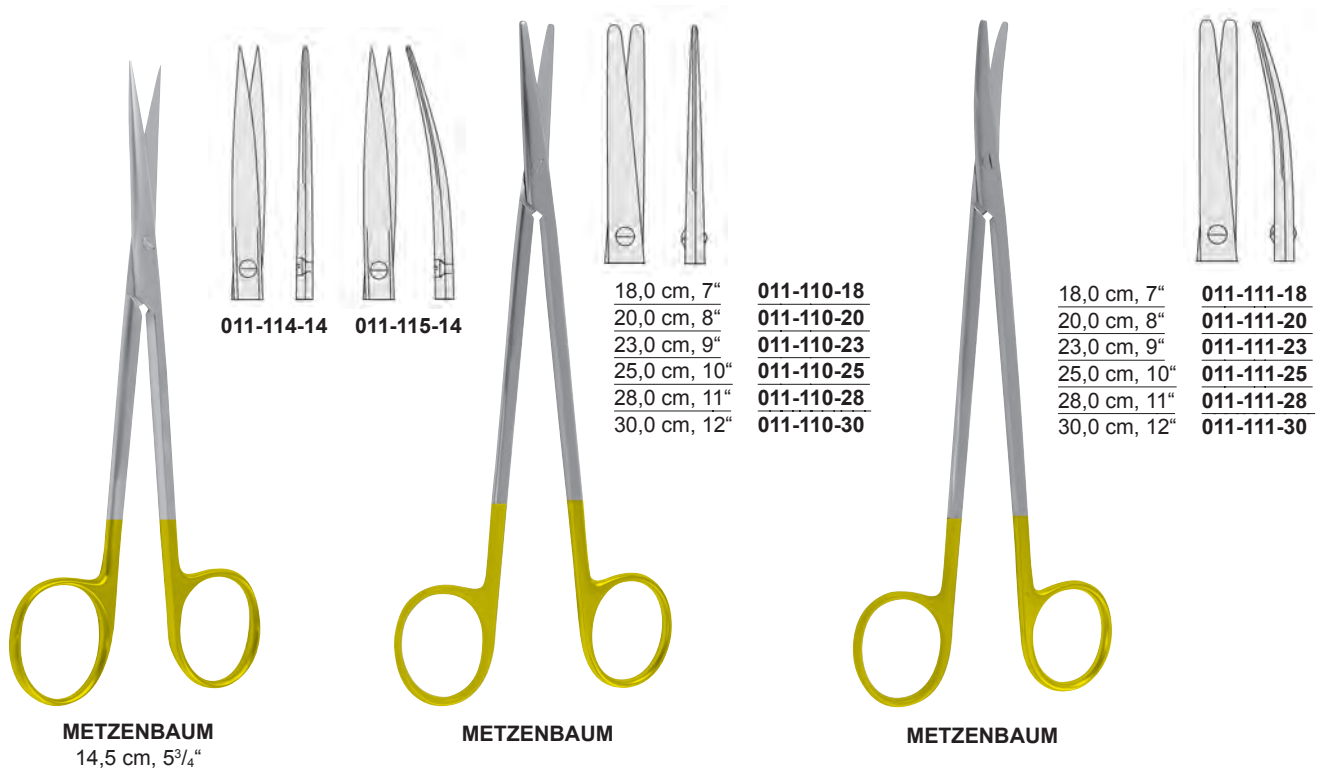
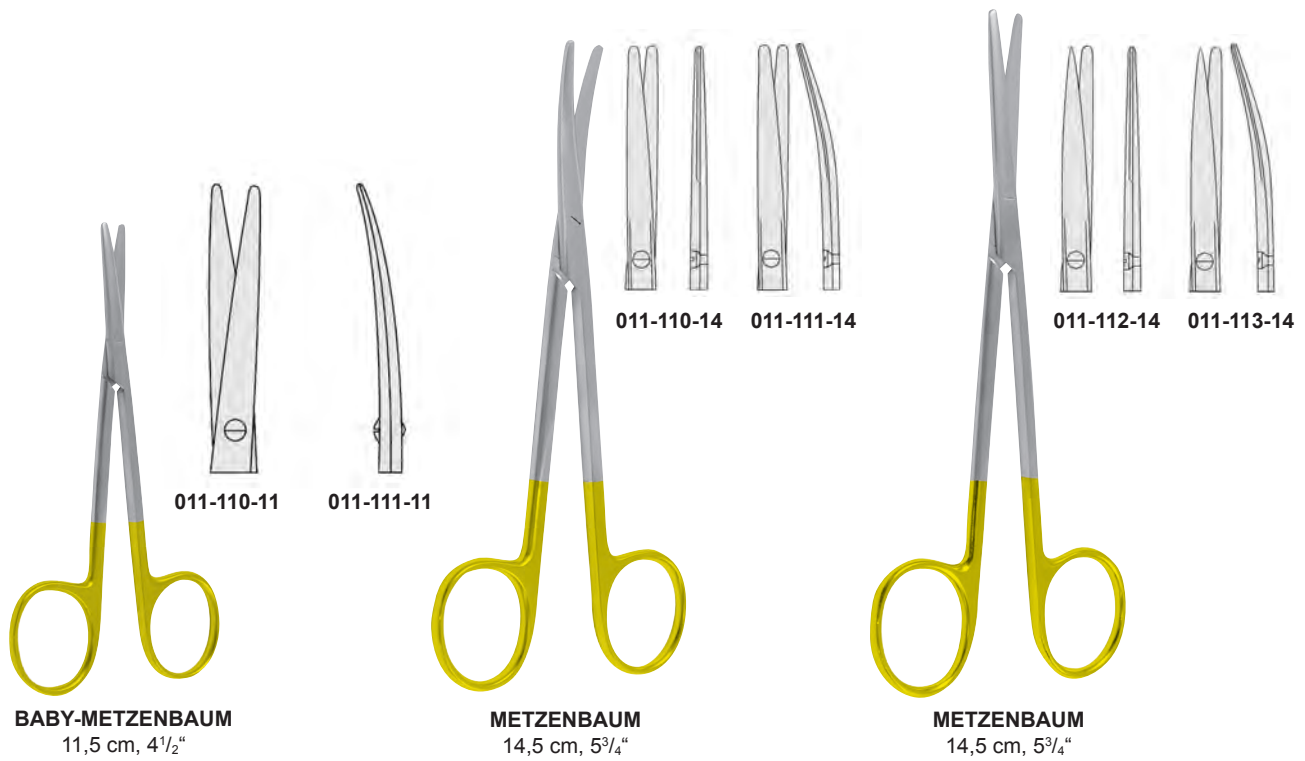


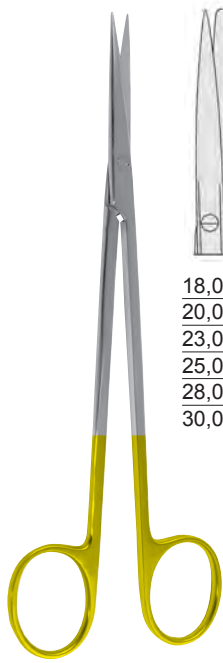
**LEXER**

16,0 cm, 6 <sup>1</sup> / <sub>4</sub> "	<b>011-141-16</b>
21,0 cm, 8 <sup>1</sup> / <sub>4</sub> "	<b>011-141-21</b>

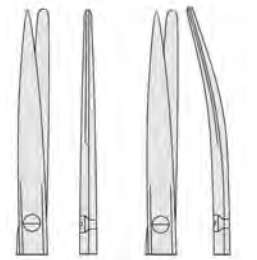


Präparierscheren mit Hartmetallschneiden  
 Dissecting Scissors with tungsten carbide edges  
 Tijeras para disección con filos de carburo tungsteno  
 Forbici per dissezione con lame in carburo di tungsteno

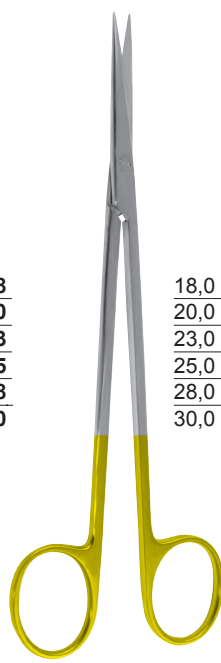




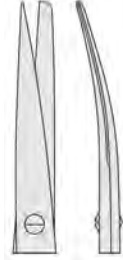
**METZENBAUM**



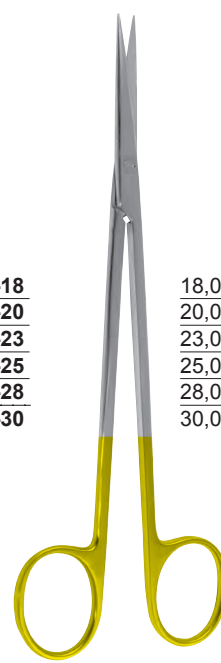
- 18,0 cm, 7" **011-112-18**
- 20,0 cm, 8" **011-112-20**
- 23,0 cm, 9" **011-112-23**
- 25,0 cm, 10" **011-112-25**
- 28,0 cm, 11" **011-112-28**
- 30,0 cm, 12" **011-112-30**



**METZENBAUM**



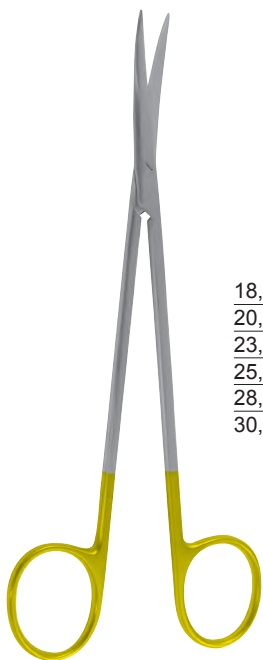
- 18,0 cm, 7" **011-113-18**
- 20,0 cm, 8" **011-113-20**
- 23,0 cm, 9" **011-113-23**
- 25,0 cm, 10" **011-113-25**
- 28,0 cm, 11" **011-113-28**
- 30,0 cm, 12" **011-113-30**



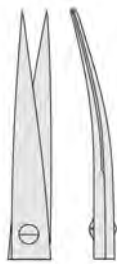
**METZENBAUM**



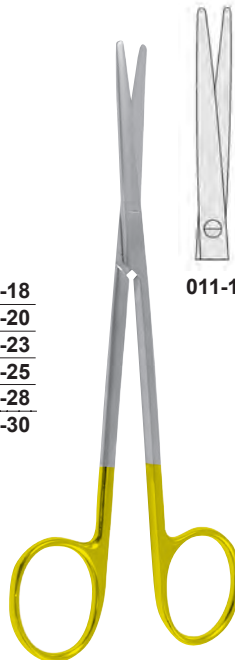
- 18,0 cm, 7" **011-114-18**
- 20,0 cm, 8" **011-114-20**
- 23,0 cm, 9" **011-114-23**
- 25,0 cm, 10" **011-114-25**
- 28,0 cm, 11" **011-114-28**
- 30,0 cm, 12" **011-114-30**



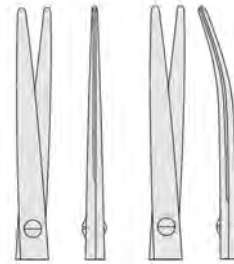
**METZENBAUM**



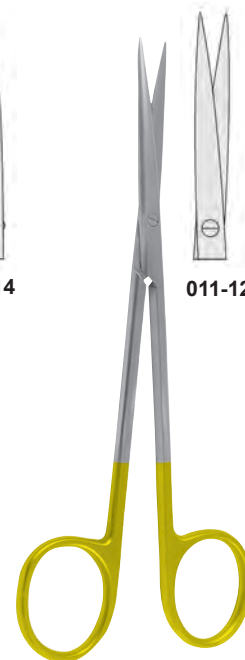
- 18,0 cm, 7" **011-115-18**
- 20,0 cm, 8" **011-115-20**
- 23,0 cm, 9" **011-115-23**
- 25,0 cm, 10" **011-115-25**
- 28,0 cm, 11" **011-115-28**
- 30,0 cm, 12" **011-115-30**



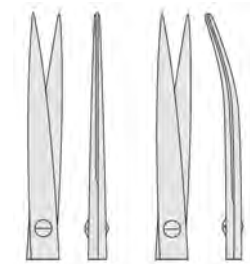
**METZENBAUM-FINO**  
14,5 cm, 5<sup>3</sup>/<sub>4</sub>"



- 011-120-14**
- 011-121-14**

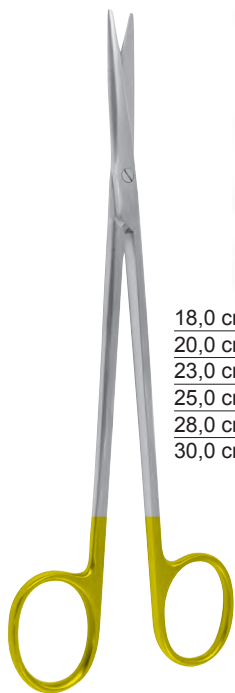


**METZENBAUM-FINO**  
14,5 cm, 5<sup>3</sup>/<sub>4</sub>"



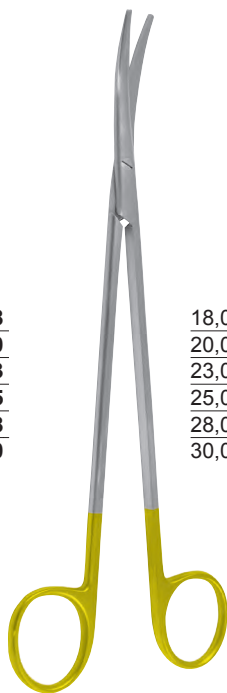
- 011-124-14**
- 011-125-14**

Präparierscheren mit Hartmetallschneiden  
 Dissecting Scissors with tungsten carbide edges  
 Tijeras para disección con filos de carburo tungsteno  
 Forbici per dissezione con lame in carburo di tungsteno



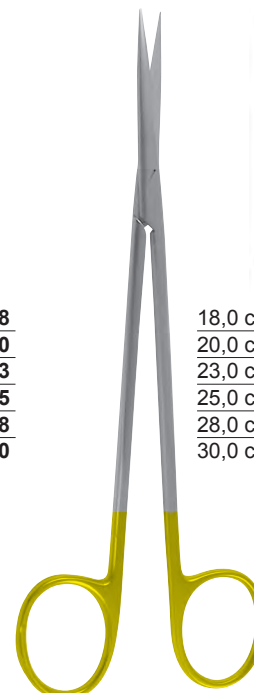
18,0 cm, 7"	<b>011-120-18</b>
20,0 cm, 8"	<b>011-120-20</b>
23,0 cm, 9"	<b>011-120-23</b>
25,0 cm, 10"	<b>011-120-25</b>
28,0 cm, 11"	<b>011-120-28</b>
30,0 cm, 12"	<b>011-120-30</b>

**METZENBAUM-FINO**



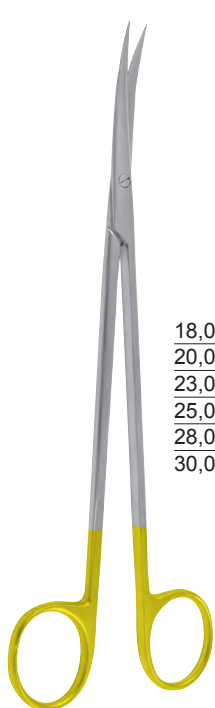
18,0 cm, 7"	<b>011-121-18</b>
20,0 cm, 8"	<b>011-121-20</b>
23,0 cm, 9"	<b>011-121-23</b>
25,0 cm, 10"	<b>011-121-25</b>
28,0 cm, 11"	<b>011-121-28</b>
30,0 cm, 12"	<b>011-121-30</b>

**METZENBAUM-FINO**



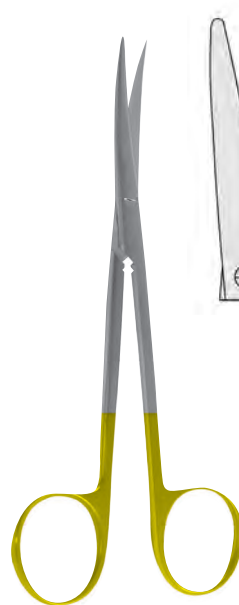
18,0 cm, 7"	<b>011-124-18</b>
20,0 cm, 8"	<b>011-124-20</b>
23,0 cm, 9"	<b>011-124-23</b>
25,0 cm, 10"	<b>011-124-25</b>
28,0 cm, 11"	<b>011-124-28</b>
30,0 cm, 12"	<b>011-124-30</b>

**METZENBAUM-FINO**

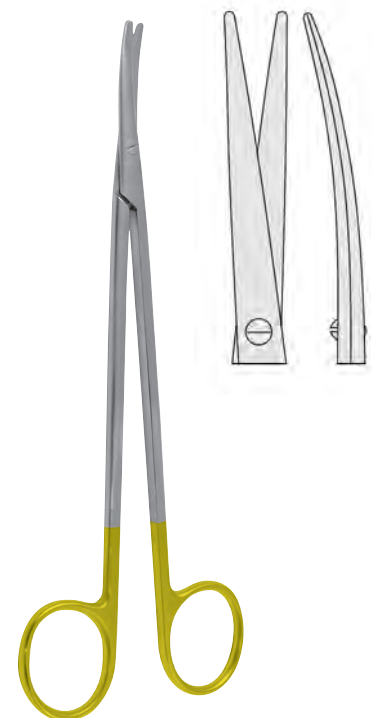


18,0 cm, 7"	<b>011-125-18</b>
20,0 cm, 8"	<b>011-125-20</b>
23,0 cm, 9"	<b>011-125-23</b>
25,0 cm, 10"	<b>011-125-25</b>
28,0 cm, 11"	<b>011-125-28</b>
30,0 cm, 12"	<b>011-125-30</b>

**METZENBAUM-FINO**



**METZENBAUM-LAHEY**  
 14,0 cm, 5 1/2"  
**011-137-14**



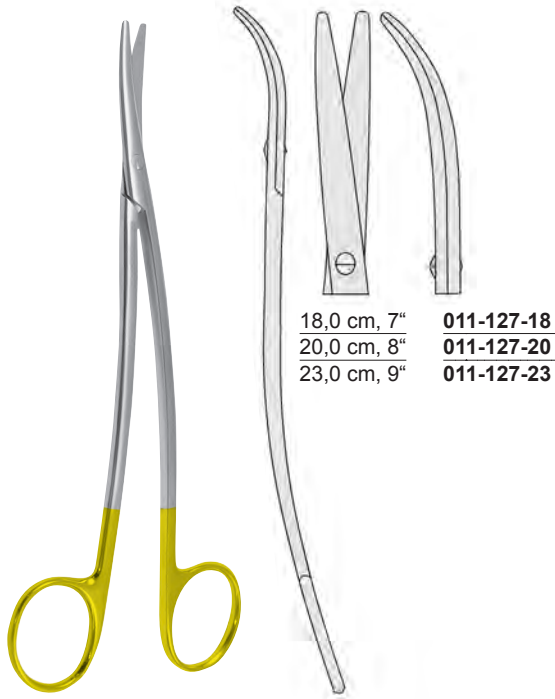
**TOENNIS-ADSON**  
 17,0 cm, 6 3/4"  
**011-139-17**



**IZIAL DENTAL SURGICAL**

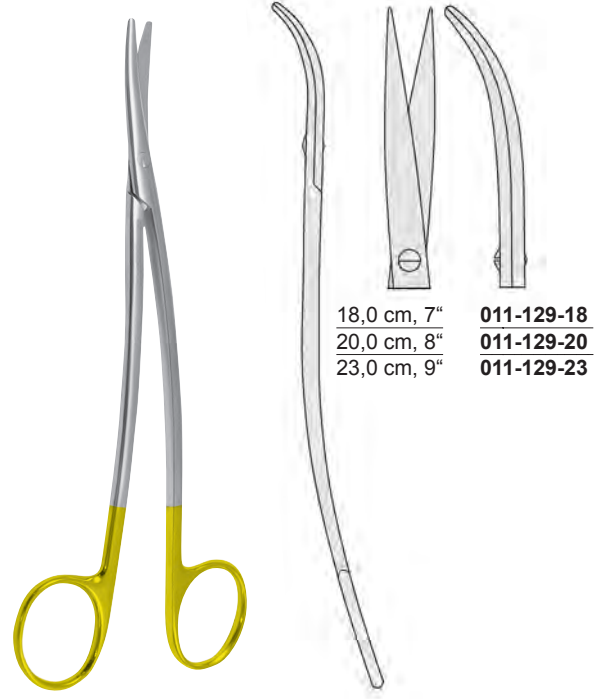
Manufacturer And Exporter Of Surgical Dental & Manicure

Präparierscheren mit Hartmetallschneiden  
Dissecting Scissors with tungsten carbide edges  
Tijeras para disección con filos de carburo tungsteno  
Forbici per dissezione con lame in carburo di tungsteno



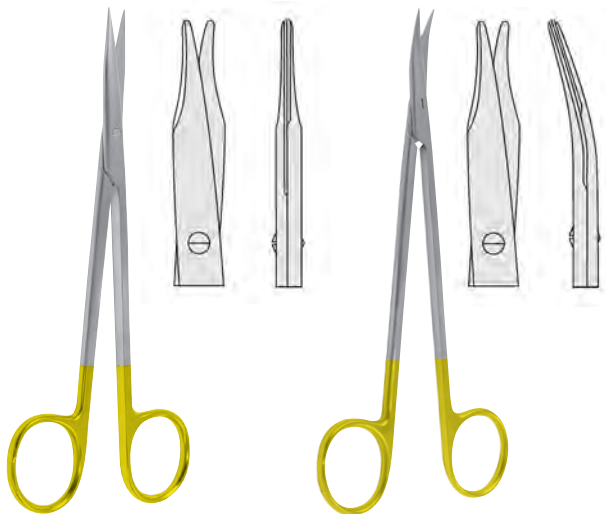
18,0 cm, 7" **011-127-18**  
20,0 cm, 8" **011-127-20**  
23,0 cm, 9" **011-127-23**

**METZENBAUM-FINO S**

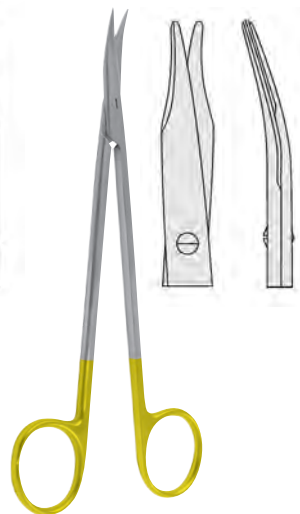


18,0 cm, 7" **011-129-18**  
20,0 cm, 8" **011-129-20**  
23,0 cm, 9" **011-129-23**

**METZENBAUM-FINO S**



**REYNOLDS**  
15,0 cm, 6"  
**011-210-15**



**REYNOLDS**  
15,0 cm, 6"  
**011-211-15**



**HYSTEREKTOMY**  
25,5 cm, 10"  
**011-663-25**

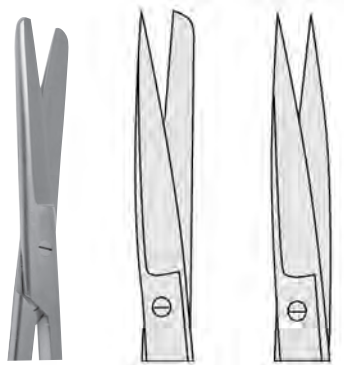


**HYSTEREKTOMY**  
25,0 cm, 9<sup>3</sup>/<sub>4</sub>"  
**011-665-25**

Gynäkologische Scheren mit Hartmetallschneiden  
 Gynecology Scissors with tungsten carbide edges  
 Tijeras para ginecología con filos de carburo tungsteno  
 Forbici per ginecologia con lame in carburo di tungsteno



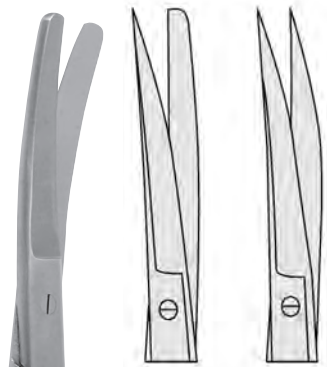
**SIMS**



20,0 cm, 8"	<b>011-600-20</b>	<b>011-602-20</b>	<b>011-604-20</b>
23,0 cm, 9"	<b>011-600-23</b>	<b>011-602-23</b>	<b>011-604-23</b>



**SIMS**



20,0 cm, 8"	<b>011-601-20</b>	<b>011-603-20</b>	<b>011-605-20</b>
23,0 cm, 9"	<b>011-601-23</b>	<b>011-603-23</b>	<b>011-605-23</b>



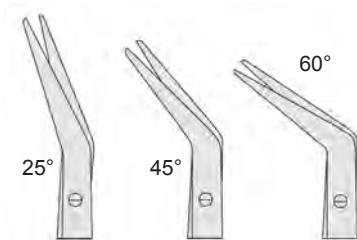
**DIETRICH**  
17,5 cm, 6<sup>7</sup>/<sub>8</sub>"  
011-552-17



**POTTS DE MARTEL**  
24,0 cm, 9<sup>1</sup>/<sub>2</sub>"  
011-548-24

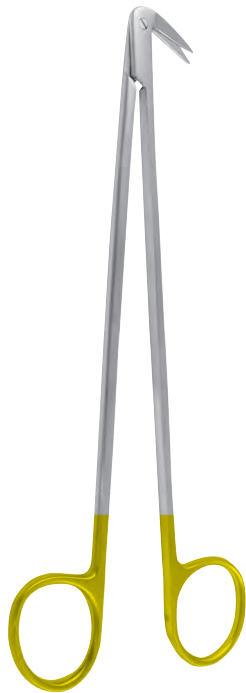


**DE BAKEY**

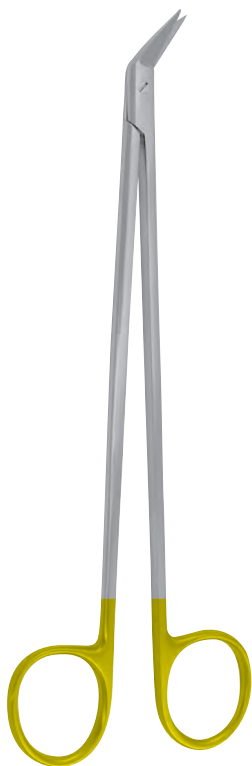


20,0 cm, 8"	011-543-25	011-543-45	011-543-60
23,0 cm, 9"	011-545-25	011-545-45	011-545-60

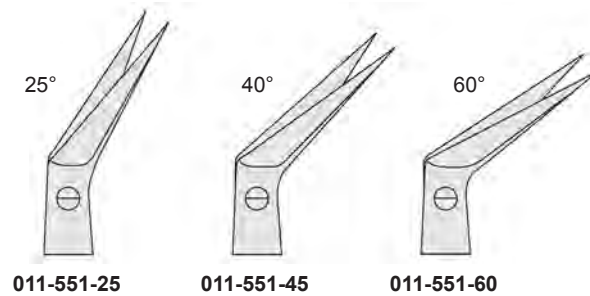
Gefäßscheren mit Hartmetallschneiden  
Vascular Scissors with tungsten carbide edges  
Tijeras vasculares con filos de carburo tungsteno  
Forbici vascolari con lame in carburo di tungsteno



**DIETHRICH-HEGEMANN**  
18,0 cm, 7"

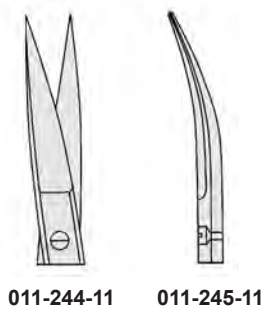


**POTTS-SMITH**  
18,0 cm, 7 1/2"

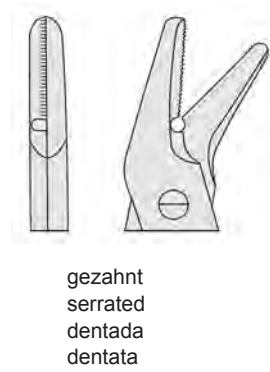




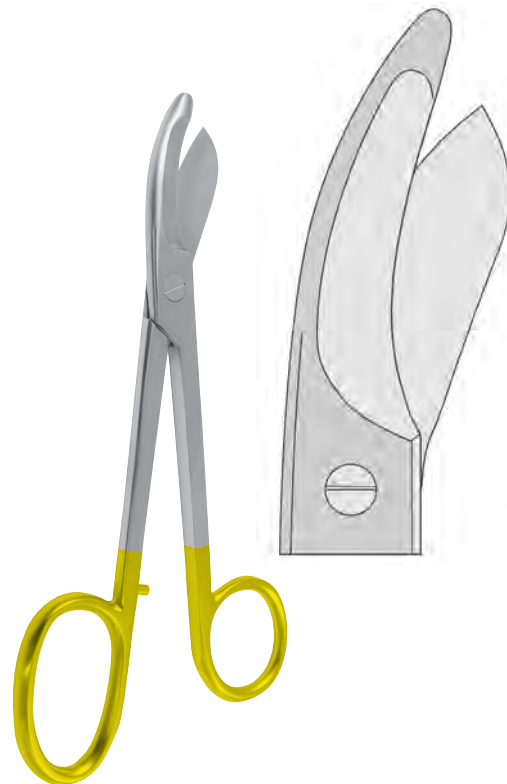
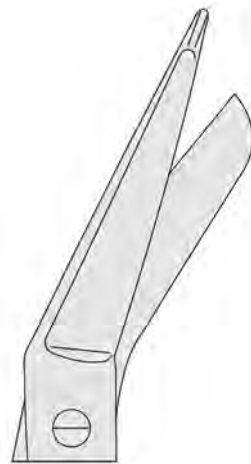
**IRIS**  
11,5 cm, 4 1/2"



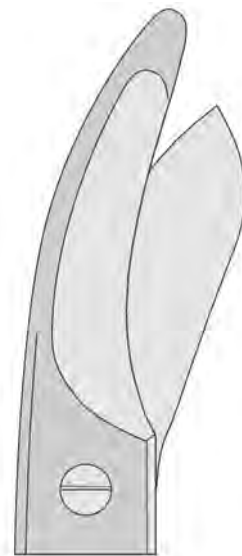
**UNIVERSAL**  
12,0 cm, 4 3/4"  
011-800-12



**LISTER**  
18,0 cm, 7"  
011-900-18



**BRUNS**  
24,0 cm, 9 1/2"  
011-909-24

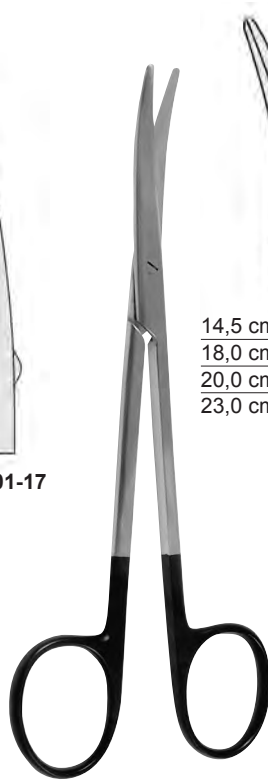
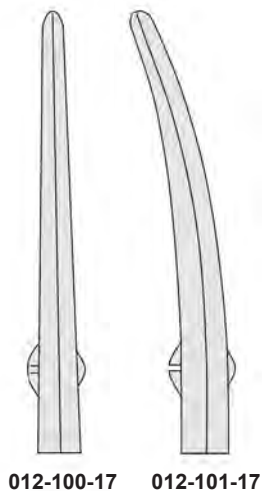




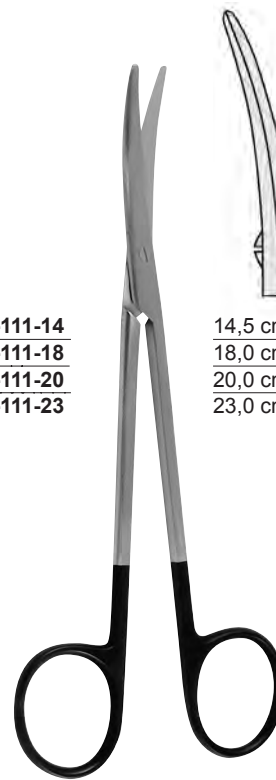
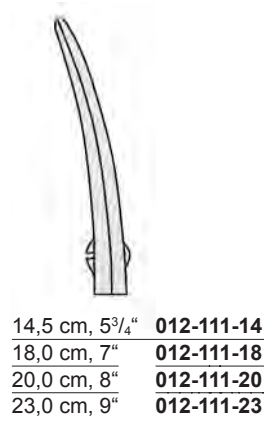
Super-Cut Scheren  
 Super-Cut Scissors  
 Tijeras Super-Cut  
 Forbici Super-Cut



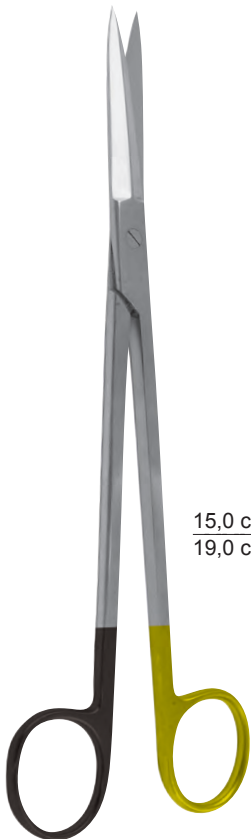
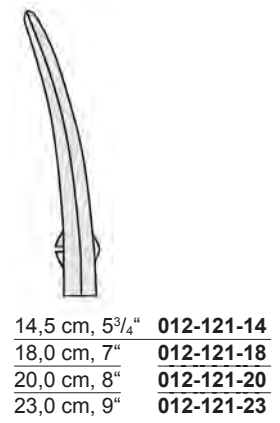
**MAYO**  
 17,0 cm, 6<sup>3</sup>/<sub>4</sub>"



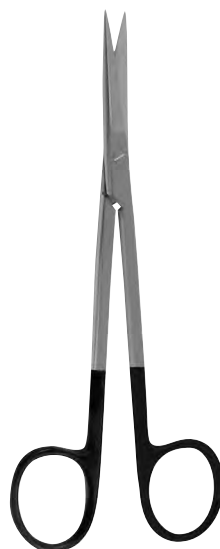
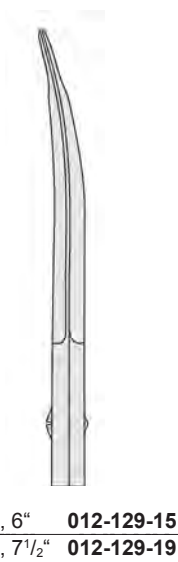
**METZENBAUM**



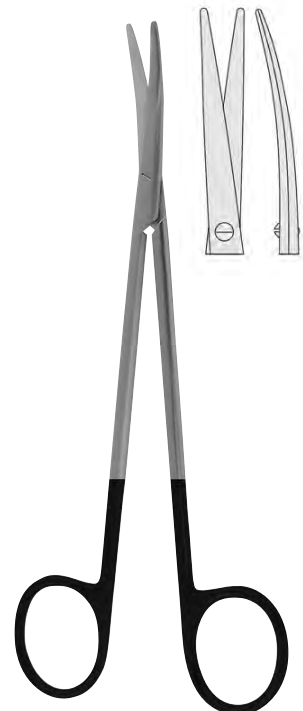
**METZENBAUM-FINO**



**KAYE FACE LIFT**



**JABALEY**  
 13,0 cm, 5"  
**012-130-13**



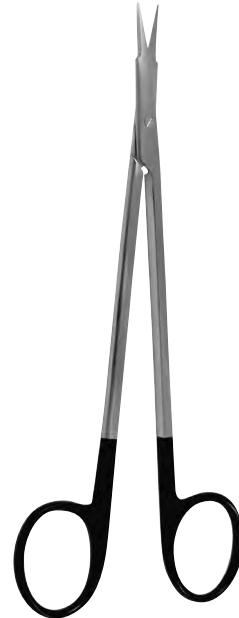
**TOENNIS-ADSON**  
 17,0 cm, 6<sup>3</sup>/<sub>4</sub>"  
**012-139-17**



**STRABISMUS**  
11,5 cm, 4 $\frac{1}{2}$ "



**JAMISON**  
15,0 cm, 6"      **012-218-15**  
18,0 cm, 7"      **012-218-18**



**REYNOLDS**  
12,5 cm, 5"  
**012-210-12**



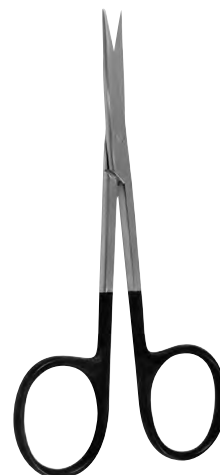
**BABY-METZENBAUM**  
11,0 cm, 4 $\frac{3}{8}$ "      **012-110-11**  
14,5 cm, 5 $\frac{3}{4}$ "      **012-110-14**



**IRIS**  
11,0 cm, 4 $\frac{3}{8}$ "  
**012-244-11**



**IRIS**  
11,0 cm, 4 $\frac{3}{8}$ "  
**012-245-11**

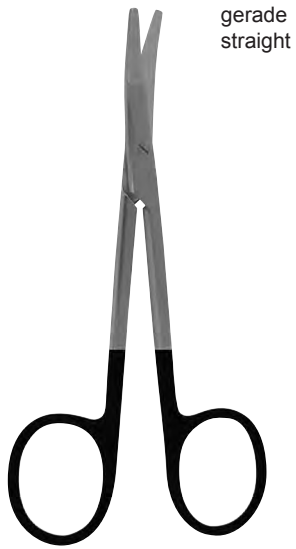


**STEVENS TENOTOMY**  
11,0 cm, 4 $\frac{3}{8}$ "  
**012-290-11**



**STEVENS T ENOTOMY**  
11,0 cm, 4 $\frac{3}{8}$ "  
**012-291-11**

Super-Cut Scheren  
 Super-Cut Scissors  
 Tijeras Super-Cut  
 Forbici Super-Cut



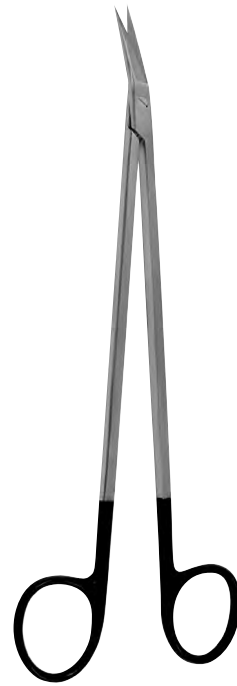
gerade  
straight

**PAR TYPE**  
 12,0 cm, 4<sup>3</sup>/<sub>4</sub>"  
 012-200-12



gebogen  
curved

**PAR TYPE**  
 12,0 cm, 4<sup>3</sup>/<sub>4</sub>"  
 012-201-12



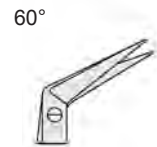
**POTTS**  
 19,0 cm, 7<sup>1</sup>/<sub>2</sub>"



012-551-25



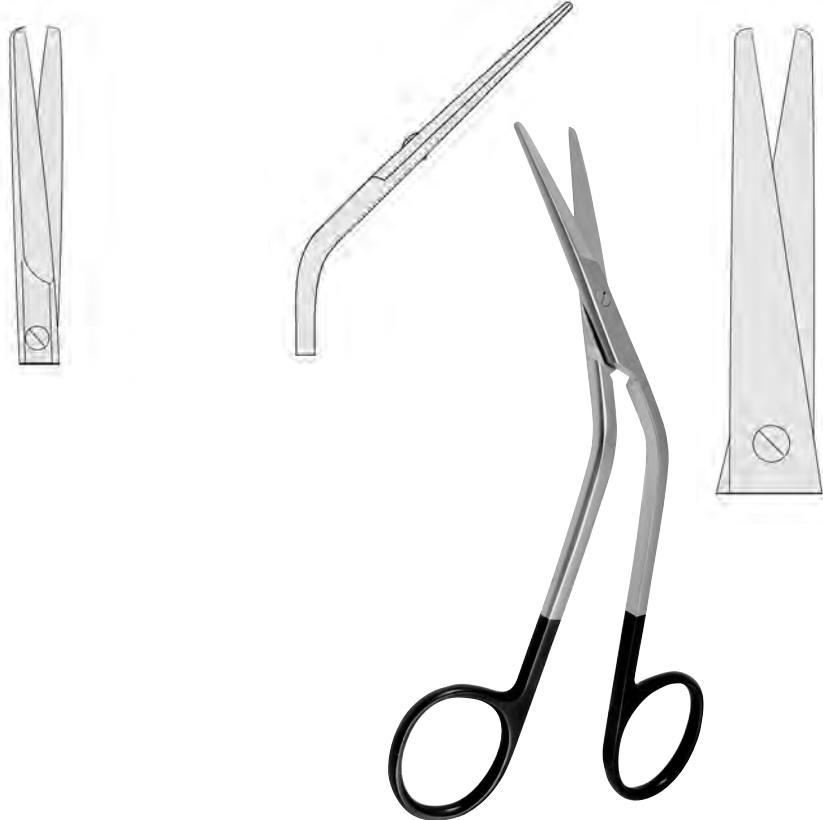
012-551-45



012-551-60



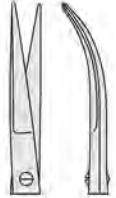
**FOMON**  
 14,5 cm, 5<sup>3</sup>/<sub>4</sub>"  
 012-343-15



**COTTLE**  
 16,5 cm, 6<sup>1</sup>/<sub>2</sub>"  
 012-511-16



**018-081-11**



**018-083-11**

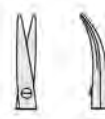
**WESTCOTT**  
 11,0 cm, 4<sup>3</sup>/<sub>8</sub>"



gezahnt  
 serrated  
 dentada  
 dentata

**GOMEL**

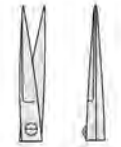
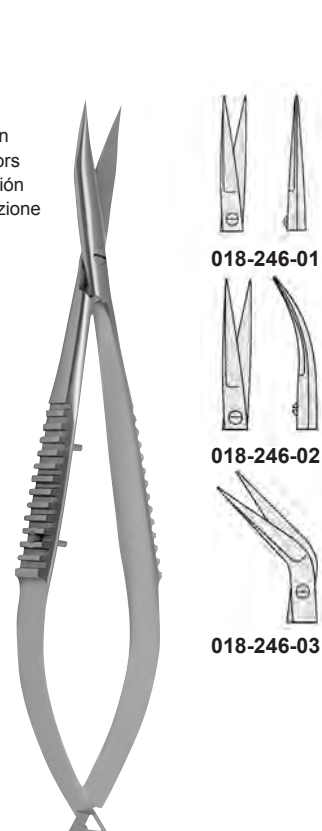
14,0 cm, 5<sup>1</sup>/<sub>2</sub>" **018-241-14Z**  
 16,0 cm, 6<sup>1</sup>/<sub>4</sub>" **018-241-16Z**



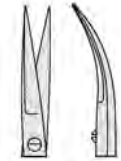
Mikro-Präparierscheren  
 Micro-dissecting scissors  
 Micro-tijeras de disección  
 Micro-forbici per dissezione

**HEPP SCHEIDEL**

14,0 cm, 5<sup>1</sup>/<sub>2</sub>" **018-243-14**  
 16,0 cm, 6<sup>1</sup>/<sub>4</sub>" **018-243-16**



**018-246-01**



**018-246-02**



**018-246-03**

18,5 cm, 7<sup>1</sup>/<sub>4</sub>"



**STEVENS**



18,5 cm, 7<sup>1</sup>/<sub>4</sub>" **018-290-01** **018-290-02** **018-290-03** **018-290-04**  
 22,5 cm, 8<sup>3</sup>/<sub>4</sub>" **018-291-01** **018-291-02** **018-291-03** **018-291-04**

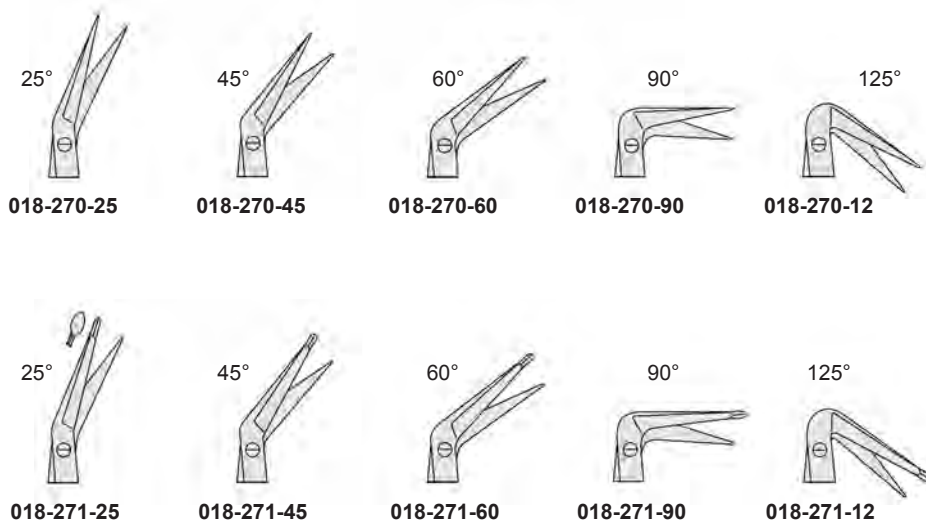


18,5 cm, 7<sup>1</sup>/<sub>4</sub>" **018-292-01** **018-292-02**  
 22,5 cm, 8<sup>3</sup>/<sub>4</sub>" **018-293-01** **018-293-02**

**Mikro-Scheren, Mikro-Disektionsscheren**  
**Micro Scissors, Micro Dissecting Scissors**  
**Micro-Tijeras, Micro-Tijeras de disección**  
**Micro-Forbici, Micro-Forbici per dissezione**



18,0 cm, 7"



018-270-25

018-270-45

018-270-60

018-270-90

018-270-12

018-271-25

018-271-45

018-271-60

018-271-90

018-271-12



15,0 cm, 6"  
018-223-15



15,0 cm, 6"  
018-223-15Z

gezahnt  
serrated  
dentada  
dentata



15,0 cm, 6"  
018-201-15



18,0 cm, 7"  
018-201-18



15,0 cm, 6"  
018-232-15



15,0 cm, 6"  
018-232-15Z

gezahnt  
serrated  
dentada  
dentata



15,0 cm, 6"  
018-203-15



18,0 cm, 7"  
018-203-18

**Pinzetten**

**Forceps**

**Pinzas**

**Pinze**



**STANDARD**

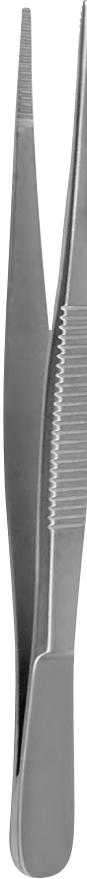
10,5 cm, 4 1/8"	<b>020-002-10</b>
11,5 cm, 4 1/2"	<b>020-002-11</b>
13,0 cm, 5"	<b>020-002-13</b>
14,5 cm, 5 3/4"	<b>020-002-14</b>
15,0 cm, 6"	<b>020-002-15</b>
16,0 cm, 6 1/4"	<b>020-002-16</b>
18,0 cm, 7"	<b>020-002-18</b>
20,0 cm, 8"	<b>020-002-20</b>
25,0 cm, 10"	<b>020-002-25</b>
30,0 cm, 12"	<b>020-002-30</b>



schmal  
 narrow  
 estrechos  
 stretti

**STANDARD**

10,5 cm, 4 1/8"	<b>020-003-10</b>
11,5 cm, 4 1/2"	<b>020-003-11</b>
13,0 cm, 5"	<b>020-003-13</b>
14,5 cm, 5 3/4"	<b>020-003-14</b>
15,0 cm, 6"	<b>020-003-15</b>
16,0 cm, 6 1/4"	<b>020-003-16</b>
18,0 cm, 7"	<b>020-003-18</b>
20,0 cm, 8"	<b>020-003-20</b>
25,0 cm, 10"	<b>020-003-25</b>
30,0 cm, 12"	<b>020-003-30</b>



schmal  
 narrow  
 estrechos  
 stretti

**STANDARD**

10,5 cm, 4 1/8"	<b>020-004-10</b>
11,5 cm, 4 1/2"	<b>020-004-11</b>
13,0 cm, 5"	<b>020-004-13</b>
14,5 cm, 5 3/4"	<b>020-004-14</b>
15,0 cm, 6"	<b>020-004-15</b>
16,0 cm, 6 1/4"	<b>020-004-16</b>
18,0 cm, 7"	<b>020-004-18</b>
20,0 cm, 8"	<b>020-004-20</b>
25,0 cm, 10"	<b>020-004-25</b>
30,0 cm, 12"	<b>020-004-30</b>



fein  
 fine  
 finas  
 fini

**STANDARD**

10,5 cm, 4 1/8"	<b>020-010-10</b>
11,5 cm, 4 1/2"	<b>020-010-11</b>
13,0 cm, 5"	<b>020-010-13</b>
14,5 cm, 5 3/4"	<b>020-010-14</b>
15,0 cm, 6"	<b>020-010-15</b>
16,0 cm, 6 1/4"	<b>020-010-16</b>
18,0 cm, 7"	<b>020-010-18</b>
20,0 cm, 8"	<b>020-010-20</b>
25,0 cm, 10"	<b>020-010-25</b>
30,0 cm, 12"	<b>020-010-30</b>





**IZIAL DENTAL SURGICAL**  
 Manufacturer And Exporter Of Surgical Dental & Manicure

**Anatomische Pinzetten**  
**Dissecting Forceps**  
**Pinzas de disección**  
**Pinze anatomiche per dissezione**

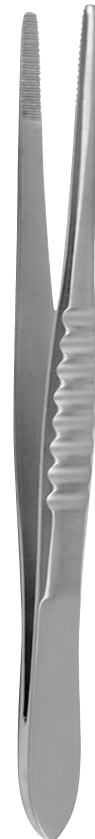


fein  
 fine  
 finas  
 fini  
 тонкие



fein  
 fine  
 finas  
 fini

mit Stift  
 with pin  
 con perno  
 con espiga



schmal  
 narrow  
 estrechos  
 stretti  
 узкие

10,5 cm, 4 <sup>1</sup> / <sub>8</sub> "	<b>020-011-10</b>
11,5 cm, 4 <sup>1</sup> / <sub>2</sub> "	<b>020-011-11</b>
13,0 cm, 5"	<b>020-011-13</b>
14,5 cm, 5 <sup>3</sup> / <sub>4</sub> "	<b>020-011-14</b>
16,0 cm, 6 <sup>1</sup> / <sub>4</sub> "	<b>020-011-16</b>
18,0 cm, 7"	<b>020-011-18</b>
20,0 cm, 8"	<b>020-011-20</b>
25,0 cm, 10"	<b>020-011-25</b>
30,0 cm, 12"	<b>020-011-30</b>

10,5 cm, 4 <sup>1</sup> / <sub>8</sub> "	<b>020-018-10</b>
11,5 cm, 4 <sup>1</sup> / <sub>2</sub> "	<b>020-018-11</b>
13,0 cm, 5"	<b>020-018-13</b>
14,5 cm, 5 <sup>3</sup> / <sub>4</sub> "	<b>020-018-14</b>
16,0 cm, 6 <sup>1</sup> / <sub>4</sub> "	<b>020-018-16</b>
18,0 cm, 7"	<b>020-018-18</b>
20,0 cm, 8"	<b>020-018-20</b>
25,0 cm, 10"	<b>020-018-25</b>
30,0 cm, 12"	<b>020-018-30</b>

MOD. USA	
12,0 cm, 4 <sup>3</sup> / <sub>4</sub> "	<b>020-006-10</b>
13,0 cm, 5"	<b>020-006-13</b>
14,5 cm, 5 <sup>3</sup> / <sub>4</sub> "	<b>020-006-14</b>
15,0 cm, 6"	<b>020-006-15</b>
18,0 cm, 7"	<b>020-006-18</b>
20,0 cm, 8"	<b>020-006-20</b>
25,5 cm, 10"	<b>020-006-25</b>
30,0 cm, 12"	<b>020-006-30</b>

MOD. USA	
12,0 cm, 4 <sup>3</sup> / <sub>4</sub> "	<b>020-012-11</b>
13,0 cm, 5"	<b>020-012-13</b>
14,5 cm, 5 <sup>3</sup> / <sub>4</sub> "	<b>020-012-14</b>
15,0 cm, 6"	<b>020-012-15</b>
18,0 cm, 7"	<b>020-012-18</b>
20,0 cm, 8"	<b>020-012-20</b>
25,5 cm, 10"	<b>020-012-25</b>

Anatomische Pinzetten  
 Dissecting Forceps  
 Pinzas de disección  
 Pinze anatomiche per dissezione



**ADSON**  
 12,0 cm, 4<sup>3</sup>/<sub>4</sub>" **020-070-12**  
 15,0 cm, 6" **020-070-15**



**MICRO-ADSON**  
 12,0 cm, 4<sup>3</sup>/<sub>4</sub>" **020-076-12**  
 15,0 cm, 6" **020-076-15**



**STILLE**  
 15,0 cm, 6"  
**020-008-15**



**MC INDOE**  
 15,0 cm, 6"  
**020-158-15**



**TAYLOR**  
 17,5 cm, 6<sup>5</sup>/<sub>8</sub>"  
**020-114-17**



**TAYLOR**  
 17,5 cm, 6<sup>5</sup>/<sub>8</sub>"  
**020-115-17**



**TAYLOR**  
 18,5 cm, 7<sup>1</sup>/<sub>4</sub>"  
**020-117-18**



**GERALD**  
 18,0 cm, 7"  
**020-102-18**



**GERALD**  
18,0 cm, 7"  
**020-103-18**



**POTTS-SMITH**  
18,0 cm, 7" **020-026-18**  
21,0 cm, 8<sup>1</sup>/<sub>4</sub>" **020-026-21**  
25,0 cm, 10" **020-026-25**



**POTTS-SMITH**  
18,0 cm, 7" **020-027-18**  
21,0 cm, 8<sup>1</sup>/<sub>4</sub>" **020-027-21**  
25,0 cm, 10" **020-027-25**



**SEMKEN**  
12,5 cm, 5" **020-040-12**  
15,0 cm, 6" **020-040-15**



**CUSHING**  
17,5 cm, 6<sup>5</sup>/<sub>8</sub>"  
**020-092-17**



**CUSHING**  
17,5 cm, 6<sup>5</sup>/<sub>8</sub>"  
**020-093-17**



**BROPHY**  
20,0 cm, 8"  
**020-094-20**

Anatomische Pinzetten  
 Dissecting Forceps  
 Pinzas de disección  
 Pinze anatomiche per dissezione  
 Пинцеты анатомические



**BROPHY**  
 20,0 cm, 8"  
 020-095-20



**BONNEY**  
 18,0 cm, 7"  
 020-120-18



**SINGLE-TUTTLE**  
 23,0 cm, 9"  
 020-516-23



**DENNIS BROWN**  
 20,0 cm, 8"  
 020-126-20



**DUEHRSEN**  
 20,0 cm, 8"  
 020-470-20



**WAUGH**  
 15,0 cm, 6"    **020-130-15**  
 20,0 cm, 8"    **020-130-20**




**RAMSEY**  
 18,0 cm, 7"  
 020-136-18



 1 x 2



 2 x 3



 3 x 4



 4 x 5



**STANDARD**

10,5 cm, 4 <sup>1</sup> / <sub>8</sub> "	<b>020-200-10</b>
11,5 cm, 4 <sup>1</sup> / <sub>2</sub> "	<b>020-200-11</b>
13,0 cm, 5"	<b>020-200-13</b>
14,5 cm, 5 <sup>3</sup> / <sub>4</sub> "	<b>020-200-14</b>
15,0 cm, 6"	<b>020-200-15</b>
16,0 cm, 6 <sup>1</sup> / <sub>4</sub> "	<b>020-200-16</b>
18,0 cm, 7"	<b>020-200-18</b>
20,0 cm, 8"	<b>020-200-20</b>
25,0 cm, 10"	<b>020-200-25</b>
30,0 cm, 12"	<b>020-200-30</b>

11,5 cm, 4 <sup>1</sup> / <sub>2</sub> "	<b>020-252-11</b>
13,0 cm, 5"	<b>020-252-13</b>
14,5 cm, 5 <sup>3</sup> / <sub>4</sub> "	<b>020-252-14</b>
16,0 cm, 6 <sup>1</sup> / <sub>4</sub> "	<b>020-252-16</b>
18,0 cm, 7"	<b>020-252-18</b>
20,0 cm, 8"	<b>020-252-20</b>
25,0 cm, 10"	<b>020-252-25</b>
30,0 cm, 12"	<b>020-252-30</b>

13,0 cm, 5"	<b>020-254-13</b>
14,5 cm, 5 <sup>3</sup> / <sub>4</sub> "	<b>020-254-14</b>
16,0 cm, 6 <sup>1</sup> / <sub>4</sub> "	<b>020-254-16</b>
18,0 cm, 7"	<b>020-254-18</b>
20,0 cm, 8"	<b>020-254-20</b>

13,0 cm, 5"	<b>020-256-13</b>
14,5 cm, 5 <sup>3</sup> / <sub>4</sub> "	<b>020-256-14</b>
16,0 cm, 6 <sup>1</sup> / <sub>4</sub> "	<b>020-256-16</b>
18,0 cm, 7"	<b>020-256-18</b>
20,0 cm, 8"	<b>020-256-20</b>

Chirurgische Pinzetten  
Tissue Forceps  
Pinzas quirúrgicas  
Pinze per chirurgia  
Пинцеты хирургические

fein  
fine  
finas  
fini

mit Stift  
with pin  
con perno  
con espiga

mit Stift  
with pin  
con perno  
con espiga

englische Modelle  
english patterns  
modelos ingleses  
modell inglese

↔ 1 x 2



13,0 cm, 5"	<b>020-210-13</b>
14,5 cm, 5 <sup>3</sup> / <sub>4</sub> "	<b>020-210-14</b>
15,5 cm, 6"	<b>020-210-15</b>
16,0 cm, 6 <sup>1</sup> / <sub>4</sub> "	<b>020-210-16</b>
18,0 cm, 7"	<b>020-210-18</b>
20,0 cm, 8"	<b>020-210-20</b>
25,0 cm, 10"	<b>020-210-25</b>
30,0 cm, 12"	<b>020-210-30</b>

↔ 1 x 2



13,0 cm, 5"	<b>020-218-13</b>
14,5 cm, 5 <sup>3</sup> / <sub>4</sub> "	<b>020-218-14</b>
15,5 cm, 6"	<b>020-218-15</b>
16,0 cm, 6 <sup>1</sup> / <sub>4</sub> "	<b>020-218-16</b>
18,0 cm, 7"	<b>020-218-18</b>
20,0 cm, 8"	<b>020-218-20</b>
25,0 cm, 10"	<b>020-218-25</b>
30,0 cm, 12"	<b>020-218-30</b>

↔ 1 x 2



13,0 cm, 5"	<b>020-219-13</b>
14,5 cm, 5 <sup>3</sup> / <sub>4</sub> "	<b>020-219-14</b>
16,0 cm, 6 <sup>1</sup> / <sub>4</sub> "	<b>020-219-16</b>
18,0 cm, 7"	<b>020-219-18</b>
20,0 cm, 8"	<b>020-219-20</b>

↔ 1 x 2



13,0 cm, 5"	<b>020-236-13</b>
14,5 cm, 5 <sup>3</sup> / <sub>4</sub> "	<b>020-236-14</b>
15,0 cm, 6"	<b>020-236-15</b>



1 x 2



**MOD. USA**

12,0 cm, 4 <sup>3</sup> / <sub>4</sub> "	<b>020-206-12</b>
13,0 cm, 5"	<b>020-206-13</b>
14,5 cm, 5 <sup>3</sup> / <sub>4</sub> "	<b>020-206-14</b>
15,5 cm, 6"	<b>020-206-15</b>
18,0 cm, 7"	<b>020-206-18</b>
20,0 cm, 8"	<b>020-206-20</b>
25,0 cm, 10"	<b>020-206-25</b>
30,0 cm, 12"	<b>020-206-30</b>

2 x 3



**MOD. USA**

12,0 cm, 4 <sup>3</sup> / <sub>4</sub> "	<b>020-212-12</b>
13,0 cm, 5"	<b>020-212-13</b>
14,5 cm, 5 <sup>3</sup> / <sub>4</sub> "	<b>020-212-14</b>
15,5 cm, 6"	<b>020-212-15</b>
18,0 cm, 7"	<b>020-212-18</b>
20,0 cm, 8"	<b>020-212-20</b>
25,0 cm, 10"	<b>020-212-25</b>
30,0 cm, 12"	<b>020-212-30</b>

1 x 2



**ADSON**

12,0 cm, 4 <sup>3</sup> / <sub>4</sub> "	<b>020-270-12</b>
15,0 cm, 6"	<b>020-270-15</b>

1 x 2



**MICRO-ADSON**

12,0 cm, 4 <sup>3</sup> / <sub>4</sub> "	<b>020-276-12</b>
15,0 cm, 6"	<b>020-276-15</b>

Chirurgische Pinzetten  
 Tissue Forceps  
 Pinzas quirúrgicas  
 Pinze per chirurgia  
 Пинцеты хирургические

 2 x 3




**ADSON**  
 12,0 cm, 4<sup>3</sup>/<sub>4</sub>" **020-074-12**  
 15,0 cm, 6" **020-074-15**

7 x 7




**ADSON-BROWN**  
 12,0 cm, 4<sup>3</sup>/<sub>4</sub>" **020-288-12**  
 15,0 cm, 6" **020-288-15**

 1 x 2



**ADSON**  
 12,0 cm, 4<sup>3</sup>/<sub>4</sub>" **020-282-12**

 1 x 2




**STILLE**  
 15,0 cm, 6" **020-208-15**

 2 x 3



**STILLE**  
 15,0 cm, 6" **020-209-15**

 1 x 2



**GILLIES**  
 15,0 cm, 6" **020-300-15**

 2 x 3



**ADLERKREUTZ**  
 15,0 cm, 6" **020-382-15**  
 20,0 cm, 8" **020-382-20**

 4 x 5



**ADLERKREUTZ**  
 15,0 cm, 6" **020-384-15**  
 20,0 cm, 8" **020-384-20**





↔ 1 x 2



**SEMKEN**  
12,5 cm, 5" **020-240-12**  
15,5 cm, 6" **020-240-15**

↔ 2 x 3



**SEMKEN**  
12,5 cm, 5" **020-242-12**

↔ 1 x 2



**MC INDOE**  
15,0 cm, 6" **020-358-15**

↔ 1 x 2



**TAYLOR**  
17,5 cm, 6<sup>5</sup>/<sub>8</sub>" **020-314-17**

↔ 1 x 2



**TAYLOR**  
17,5 cm, 6<sup>5</sup>/<sub>8</sub>" **020-315-17**

↔ 1 x 2



**TAYLOR**  
17,5 cm, 6<sup>5</sup>/<sub>8</sub>" **020-317-17**

↔ 1 x 2



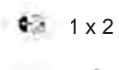
**GERALD**  
18,0 cm, 7" **020-302-18**

↔ 1 x 2



**GERALD**  
18,0 cm, 7" **020-303-18**

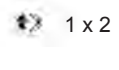
Chirurgische Pinzetten  
Tissue Forceps  
Pinzas quirúrgicas  
Pinze per chirurgia



**CUSHING**  
17,5 cm, 6<sup>5</sup>/<sub>8</sub>"  
020-292-17



**CUSHING**  
17,5 cm, 6<sup>5</sup>/<sub>8</sub>"  
020-293-17



**POTTS-SMITH**  
18,0 cm, 7"      020-226-18  
21,0 cm, 8<sup>1</sup>/<sub>4</sub>"      020-226-21  
25,0 cm, 10"      020-226-25



**WAUGH**  
15,0 cm, 6"      020-330-15  
20,0 cm, 8"      020-330-20



**BROPHY**  
20,0 cm, 8"  
020-294-20



**RUSS. MODELL**  
15,0 cm, 6"      020-456-15  
20,0 cm, 8"      020-456-20  
25,0 cm, 10"      020-456-25



**DURANTE**

14,5 cm, 5<sup>3</sup>/<sub>4</sub>" **020-460-14**  
16,0 cm, 6<sup>1</sup>/<sub>4</sub>" **020-460-16**  
20,0 cm, 8" **020-460-20**



**DUEHRSEN**

20,0 cm, 8"



1 x 2  
**020-470-12**



2 x 3  
**020-470-23**



1 x 4  
**020-470-34**



**NELSON**

15,0 cm, 6" **020-518-15**  
20,0 cm, 8" **020-518-20**  
23,0 cm, 9" **020-518-23**



**DUVAL**  
14,0 cm, 5<sup>1</sup>/<sub>2</sub>"



Fig. 1  
**020-586-14**



Fig. 2  
**020-587-14**



**COLLIN-DUVAL**  
20,0 cm, 8"



Fig. 1  
**020-494-01**

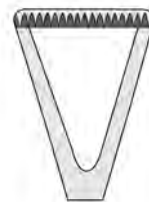


Fig. 2  
**020-494-02**

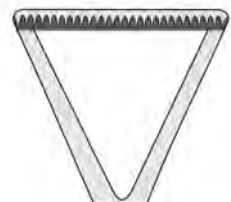


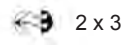
Fig. 3  
**020-494-03**

Chirurgische Pinzetten  
Tissue Forceps  
Pinzas quirúrgicas  
Pinze per chirurgia



**LANE**

14,5 cm, 5<sup>3</sup>/<sub>4</sub>" **020-420-14**  
20,0 cm, 8" **020-420-20**



**LANE**

14,5 cm, 5<sup>3</sup>/<sub>4</sub>" **020-422-14**  
20,0 cm, 8" **020-422-20**

7 x 7



**BROWN**

15,0 cm, 6" **020-410-15**  
20,0 cm, 8" **020-410-20**  
25,0 cm, 10" **020-410-25**

1 x 2



**TREVES**

13,0 cm, 5" **020-510-13**  
15,0 cm, 6" **020-510-15**



**RAMSEY**

18,0 cm, 7" **020-520-18**



**RAMSEY**

18,0 cm, 7" **020-522-18**



**RAMSEY**

18,0 cm, 7" **020-590-18**



**RAMSEY**

18,0 cm, 7" **020-592-18**



mit Stift  
with pin  
con perno  
con espiga

mit Stift  
with pin  
con perno  
con espiga



8,0 cm, 3<sup>1</sup>/<sub>4</sub>" **020-662-08**  
9,0 cm, 3<sup>1</sup>/<sub>2</sub>" **020-662-09**  
10,5 cm, 4<sup>1</sup>/<sub>8</sub>" **020-662-10**  
11,5 cm, 4<sup>1</sup>/<sub>2</sub>" **020-662-11**  
13,0 cm, 5" **020-662-13**  
14,5 cm, 5<sup>1</sup>/<sub>2</sub>" **020-662-14**

8,0 cm, 3<sup>1</sup>/<sub>4</sub>" **020-663-08**  
9,0 cm, 3<sup>1</sup>/<sub>2</sub>" **020-663-09**  
10,5 cm, 4<sup>1</sup>/<sub>8</sub>" **020-663-10**  
11,5 cm, 4<sup>1</sup>/<sub>2</sub>" **020-663-11**  
13,0 cm, 5" **020-663-13**  
14,5 cm, 5<sup>1</sup>/<sub>2</sub>" **020-663-14**

8,0 cm, 3<sup>1</sup>/<sub>4</sub>" **020-666-08**  
9,0 cm, 3<sup>1</sup>/<sub>2</sub>" **020-666-09**  
10,5 cm, 4<sup>1</sup>/<sub>8</sub>" **020-666-10**  
11,5 cm, 4<sup>1</sup>/<sub>2</sub>" **020-666-11**  
13,0 cm, 5" **020-666-13**  
14,5 cm, 5<sup>1</sup>/<sub>2</sub>" **020-666-14**

8,0 cm, 3<sup>1</sup>/<sub>4</sub>" **020-667-08**  
9,0 cm, 3<sup>1</sup>/<sub>2</sub>" **020-667-09**  
10,5 cm, 4<sup>1</sup>/<sub>8</sub>" **020-667-10**  
11,5 cm, 4<sup>1</sup>/<sub>2</sub>" **020-667-11**  
13,0 cm, 5" **020-667-13**  
14,5 cm, 5<sup>1</sup>/<sub>2</sub>" **020-667-14**

Splitterpinzetten, Mikro-Pinzetten  
 Splinter Forceps, Micro Forceps  
 Pinzas para espinas, Pinzas para microscopia  
 Pinze per schegge, Pinze per microscopia



**HUNTER**  
 10,5 cm, 4<sup>1</sup>/<sub>4</sub>"  
 020-652-10



**HUNTER**  
 10,5 cm, 4<sup>1</sup>/<sub>4</sub>"  
 020-653-10



**WALTER-CARMALT**  
 10,5 cm, 4<sup>1</sup>/<sub>4</sub>"  
 020-656-10



**WALTER-CARMALT**  
 10,5 cm, 4<sup>1</sup>/<sub>4</sub>"  
 020-657-10



**FEILCHENFELD**  
 7,5 cm, 3<sup>1</sup>/<sub>8</sub>"    020-650-07  
 9,0 cm, 3<sup>1</sup>/<sub>2</sub>"    020-650-09  
 11,5 cm, 4<sup>1</sup>/<sub>2</sub>"    020-650-11



10,0 cm, 4"  
 020-806-10



10,0 cm, 4"  
 020-807-10



**Mikro-Pinzetten**  
**Micro Forceps**  
**Pinzas para microscopia**  
**Pinze per microscopia**



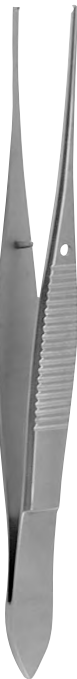
**GRAEFE**  
10,0 cm, 4"  
020-810-10



**GRAEFE**  
10,0 cm, 4"  
020-811-10



**GRAEFE**  
10,0 cm, 4"  
020-813-10



**GRAEFE**  
10,0 cm, 4"  
020-814-10



**GRAEFE**  
10,0 cm, 4"  
020-815-10



**GRAEFE**  
10,0 cm, 4"  
020-817-10



Fig. 3  
 11,5 cm, 4 1/2"  
 020-601-03



Fig. 4  
 11,5 cm, 4 1/2"  
 020-601-04



Fig. 5  
 11,5 cm, 4 1/2"  
 020-601-05



Fig. 7  
 11,5 cm, 4 1/2"  
 020-601-07

0,3 mm x 45°

0,3 mm x 90°

0,3 mm

0,3 mm x 45°



9 mm

11,0 cm, 4 3/8"  
 020-620-01



9 mm

11,0 cm, 4 3/8"  
 020-620-02



9 mm

11,0 cm, 4 3/8"  
 020-620-03



9 mm

11,0 cm, 4 3/8"  
 020-620-04

diamantbeschichtet  
 diamond coated  
 diamantado  
 diamantato





DE BAKEY

1,5 mm      2,0 mm      2,4 mm      2,8 mm



16,0 cm, 6 <sup>1</sup> / <sub>4</sub> "	<b>020-700-16</b>	<b>020-702-16</b>	<b>020-704-16</b>	<b>020-706-16</b>
20,0 cm, 8"	<b>020-700-20</b>	<b>020-702-20</b>	<b>020-704-20</b>	<b>020-706-20</b>
24,0 cm, 9 <sup>1</sup> / <sub>2</sub> "	<b>020-700-24</b>	<b>020-702-24</b>	<b>020-704-24</b>	<b>020-706-24</b>
30,0 cm, 12"	<b>020-700-30</b>	<b>020-702-30</b>	<b>020-704-30</b>	<b>020-706-30</b>

2,8 mm      3,5 mm      3,5 mm



16,0 cm, 6 <sup>1</sup> / <sub>4</sub> "	<b>020-716-16</b>	<b>020-708-16</b>	<b>020-718-16</b>
20,0 cm, 8"	<b>020-716-20</b>	<b>020-708-20</b>	<b>020-718-20</b>
24,0 cm, 9 <sup>1</sup> / <sub>2</sub> "	<b>020-716-24</b>	<b>020-708-24</b>	<b>020-718-24</b>
30,0 cm, 12"	<b>020-716-30</b>	<b>020-708-30</b>	<b>020-718-30</b>



DE BAKEY

1,5 mm      2,0 mm



16,0 cm, 6 <sup>1</sup> / <sub>4</sub> "	<b>020-701-16</b>	<b>020-703-16</b>
20,0 cm, 8"	<b>020-701-20</b>	<b>020-703-20</b>
24,0 cm, 9 <sup>1</sup> / <sub>2</sub> "	<b>020-701-24</b>	<b>020-703-24</b>
30,0 cm, 12"	<b>020-701-30</b>	<b>020-703-30</b>

**Pinzetten mit Hartmetalleinlagen**  
**Forceps with tungsten carbide inserts**  
**Pinzas con bocas de carburo tungsteno**  
**Pinze con morsi in carburo di tungsteno**



**STANDARD**

14,5 cm, 5 <sup>3</sup> / <sub>4</sub> "	<b>021-200-14</b>
16,0 cm, 6 <sup>1</sup> / <sub>4</sub> "	<b>021-200-16</b>
18,0 cm, 7"	<b>021-200-18</b>
20,0 cm, 8"	<b>021-200-20</b>
25,0 cm, 10"	<b>021-200-25</b>
30,0 cm, 12"	<b>021-200-30</b>



**STANDARD**

14,0 cm, 5 <sup>1</sup> / <sub>2</sub> "	<b>021-208-14</b>
16,0 cm, 6 <sup>1</sup> / <sub>4</sub> "	<b>021-208-16</b>
18,0 cm, 7"	<b>021-208-18</b>
20,0 cm, 8"	<b>021-208-20</b>
25,0 cm, 10"	<b>021-208-25</b>
30,0 cm, 12"	<b>021-208-30</b>



**STANDARD**

12,5 cm, 5"	<b>021-040-12</b>
15,0 cm, 6"	<b>021-040-15</b>



**STANDARD**

15,0 cm, 6"	<b>021-140-15</b>
23,0 cm, 9"	<b>021-140-23</b>
25,0 cm, 10"	<b>021-140-25</b>



**GILLIES**  
15,0 cm, 6"  
021-300-15



**MC INDOE**  
15,0 cm, 6"  
021-158-15



**GERALD**  
17,0 cm, 6<sup>3</sup>/<sub>4</sub>"

021-102-17

021-302-17



**POTTS-SMITH**  
15,0 cm, 6" 021-026-15  
18,0 cm, 7" 021-026-18  
20,0 cm, 8" 021-026-20



**BONNEY**  
17,5 cm, 6<sup>5</sup>/<sub>8</sub>"  
021-590-17



**CUSHING**  
17,5 cm, 6<sup>5</sup>/<sub>8</sub>"



021-092-17



021-093-17



**CUSHING-TAYLOR**  
18,0 cm, 7"  
021-117-18



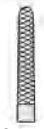
**ADSON**  
17,5 cm, 6<sup>5</sup>/<sub>8</sub>"

12,0 cm, 4<sup>3</sup>/<sub>4</sub>"  
021-070-12

12,0 cm, 4<sup>3</sup>/<sub>4</sub>"  
021-270-12

15,0 cm, 6"  
021-070-15

15,0 cm, 6"  
021-270-15



**Tuch-, Schlauchklemmen, Tupferzangen**

**Towel Clamps, Sponge and Dressing Forceps, Tubing Clamps**

**Pinzas de campo, Pinzas para vendajes y torundas y para tubos**

**Pinze per fissare le compresse, per medicatura e tamponi, e per tubi**

Tuchklemmen  
Towel Clamps  
Pinzas de campo  
Pinze per fissare le compresse



**SCHAEDEL**  
9,0 cm, 3 1/2"  
030-101-09



**ENGL. MODELL**  
9,0 cm, 3 1/2"  
030-109-09



**JONES**  
5,0 cm, 2"      **030-105-05**  
7,0 cm, 2 3/4"      **030-105-07**  
9,0 cm, 3 1/2"      **030-105-09**



**JONES**  
9,0 cm, 3 1/2"  
030-107-09

mit Schlauch- oder Kabelhalter  
with clip for tubing or cable  
con porta-tubo o porta-cable  
con porta-tubo o porta-cavo



**BACKHAUS**  
9,0 cm, 3 1/2"      **030-000-09**  
11,0 cm, 4 3/8"      **030-000-11**  
13,0 cm, 5"      **030-000-13**  
15,0 cm, 6"      **030-000-15**



11,0 cm, 4 3/8"  
**030-005-11**



**ROEDER**  
13,0 cm, 5"  
**030-010-13**



**ROEDER**  
15,0 cm, 5"  
030-010-15



**BERNHARD**  
16,5 cm, 6 1/2"  
030-044-16



Kugel / Pfanne  
Ball / Socket  
Bola / Cojinete  
Palla / Cuscinetto

13,0 cm, 5"  
030-024-13



10,0 cm, 4"  
030-014-10

13,0 cm, 5"  
030-014-13



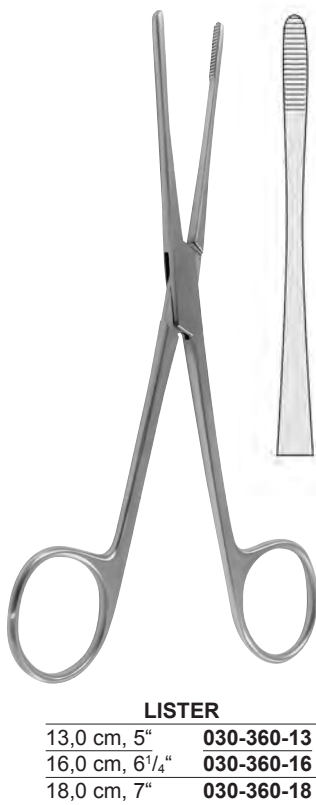
**LORNA**



**LANE**

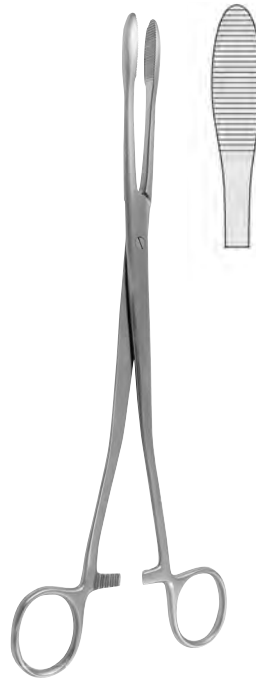
15,0 cm, 6"    **030-040-15**  
18,0 cm, 7"    **030-040-18**  
20,0 cm, 8"    **030-040-20**

Tuchklemmen, Korn- und Tupferzangen  
 Towel Clamps, Sponge and Dressing Forceps  
 Pinzas de campo, Pinzas para vendajes y torundas  
 Pinze per fissare le compresse, Pinze per medicatura e tamponi





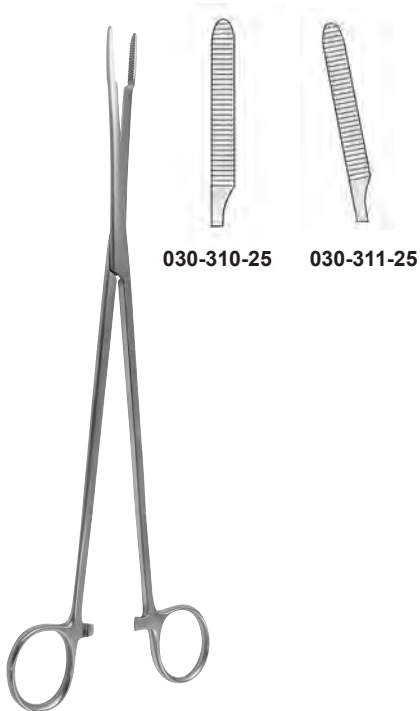
**BOZEMANN**  
26,0 cm, 10<sup>1</sup>/<sub>4</sub>"  
**030-321-26**



**COLLIN**  
25,0 cm, 9<sup>3</sup>/<sub>4</sub>"  
**030-300-25**



**CHERON**  
25,0 cm, 9<sup>3</sup>/<sub>4</sub>"  
**030-303-25**

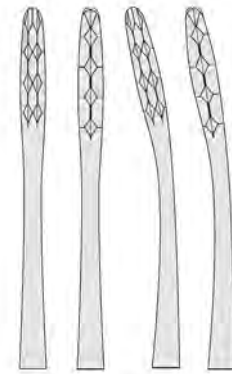


**PELKMANN**  
25,0 cm, 9<sup>3</sup>/<sub>4</sub>"

**030-310-25**    **030-311-25**



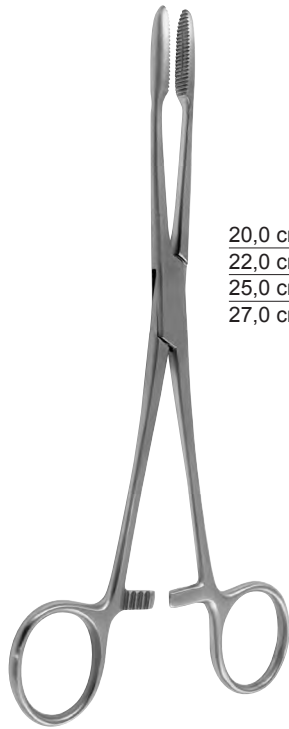
**ULRICH**



22,0 cm, 8<sup>5</sup>/<sub>8</sub>"    **030-200-22**    **030-201-22**  
25,0 cm, 9<sup>3</sup>/<sub>4</sub>"    **030-200-25**    **030-201-25**  
27,0 cm, 10<sup>5</sup>/<sub>8</sub>"    **030-200-27**    **030-201-27**



Korn- und Tupferzangen  
 Sponge and Dressing Forceps  
 Pinzas para vendajes y torundas  
 Pinze per medicatura e tamponi

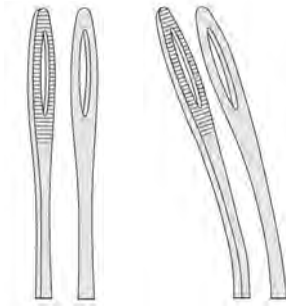


**GROSS-MAIER**

20,0 cm, 8"	<b>030-210-20</b>	<b>030-211-20</b>
22,0 cm, 8 <sup>5</sup> / <sub>8</sub> "	<b>030-210-22</b>	<b>030-211-22</b>
25,0 cm, 9 <sup>3</sup> / <sub>4</sub> "	<b>030-210-25</b>	<b>030-211-25</b>
27,0 cm, 10 <sup>5</sup> / <sub>8</sub> "	<b>030-210-27</b>	<b>030-211-27</b>



**FOERSTER**

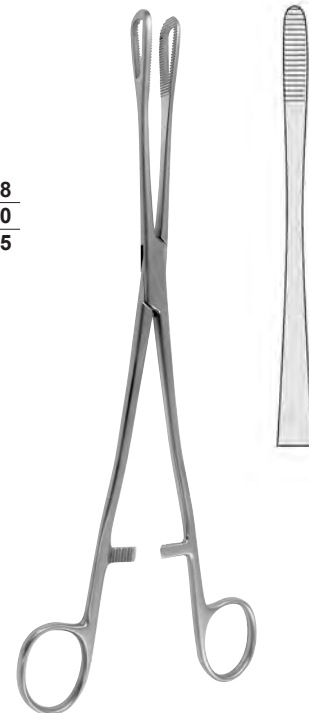


25,0 cm, 9 <sup>3</sup> / <sub>4</sub> "	<b>030-180-25</b>	<b>030-181-25</b>
--	-------------------	-------------------



**FOERSTER-BALLENGER**

18,0 cm, 7"	<b>030-160-18</b>	<b>030-161-18</b>	<b>030-170-18</b>	<b>030-171-18</b>
20,0 cm, 8"	<b>030-160-20</b>	<b>030-161-20</b>	<b>030-170-20</b>	<b>030-171-20</b>
25,0 cm, 9 <sup>3</sup> / <sub>4</sub> "	<b>030-160-25</b>	<b>030-161-25</b>	<b>030-170-25</b>	<b>030-171-25</b>



**RAMPLEY**

18,0 cm, 7"	<b>030-190-18</b>
25,0 cm, 9 <sup>3</sup> / <sub>4</sub> "	<b>030-190-25</b>



**PRESBYTERIAN**

16,5 cm, 6 1/2" **032-012-16**  
18,0 cm, 7" **032-012-18**  
20,0 cm, 8" **032-012-20**



**BERLIN**

14,5 cm, 5 3/4" **032-006-14**



15,0 cm, 6" **032-002-15**  
18,0 cm, 7" **032-002-18**  
20,0 cm, 8" **032-002-20**



15,0 cm, 6" **032-004-15**  
18,0 cm, 7" **032-004-18**  
20,0 cm, 8" **032-004-20**

**Klemmen**

**Forceps**

**Pinas**

**Pinze**

**Bulldogklemmen**  
**Bulldog Clamps**  
**Clamps Bulldog**  
**Pinze Bulldog**



3,5 cm, 1 1/2"	<b>026-014-03</b>	<b>026-015-03</b>
5,0 cm, 2"	<b>026-014-05</b>	<b>026-015-05</b>



**DIEFFENBACH**



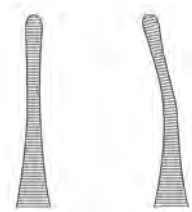
**HESS**  
**026-520-01**



**HESS**  
**026-520-02**



3,8 cm, 1 1/2"	<b>026-018-04</b>	<b>026-019-04</b>
5,0 cm, 2"	<b>026-018-05</b>	<b>026-019-05</b>
6,3 cm, 2 1/2"	<b>026-018-06</b>	<b>026-019-06</b>
7,6 cm, 3"	<b>026-018-07</b>	<b>026-019-07</b>
9,0 cm, 3 1/2"	<b>026-018-09</b>	<b>026-019-09</b>



**JOHNS-HOPKINS**



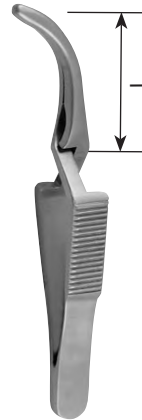
**JOHNS-HOPKINS**  
 23,0 cm, 9"  
**026-295-23**



mit atraumatischer Riefung  
 with non-traumatic serration  
 con bocas atraumáticas  
 con presa atraumatica  
 с атравматичной зазубреностью

		L	
7,5 cm, 3"	<b>026-292-07</b>	2,5 cm, 1"	
8,5 cm, 3 <sup>1</sup> / <sub>4</sub> "	<b>026-292-08</b>	3,5 cm, 1 <sup>3</sup> / <sub>8</sub> "	
10,5 cm, 4 <sup>1</sup> / <sub>8</sub> "	<b>026-292-10</b>	5,0 cm, 2"	
12,0 cm, 4 <sup>3</sup> / <sub>4</sub> "	<b>026-292-12</b>	6,8 cm, 2 <sup>3</sup> / <sub>4</sub> "	

**DE BAKEY**



mit atraumatischer Riefung  
 with non-traumatic serration  
 con bocas atraumáticas  
 con presa atraumatica  
 с атравматичной зазубреностью

		L	
7,0 cm, 2 <sup>3</sup> / <sub>4</sub> "	<b>026-293-07</b>	2,5 cm, 1"	
8,0 cm, 3 <sup>1</sup> / <sub>8</sub> "	<b>026-293-08</b>	3,5 cm, 1 <sup>3</sup> / <sub>8</sub> "	
10,0 cm, 3 <sup>3</sup> / <sub>4</sub> "	<b>026-293-10</b>	5,0 cm, 2"	
11,5 cm, 4 <sup>1</sup> / <sub>2</sub> "	<b>026-293-12</b>	6,8 cm, 2 <sup>3</sup> / <sub>4</sub> "	

**DE BAKEY**



**TITANIUM**  
 3,5 cm, 1<sup>3</sup>/<sub>8</sub>"  
 vena **027-032-35**  
 arteria **027-042-35**



**TITANIUM**  
 3,5 cm, 1<sup>3</sup>/<sub>8</sub>"  
 vena **027-033-35**  
 arteria **027-043-35**

gerade  
 straight  
 recto  
 retto



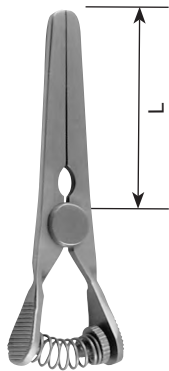
**TITANIUM**  
 4,0 cm, 1<sup>5</sup>/<sub>8</sub>"  
 vena **027-032-40**  
 arteria **027-042-40**

gebogen  
 curved  
 curvo  
 curvo



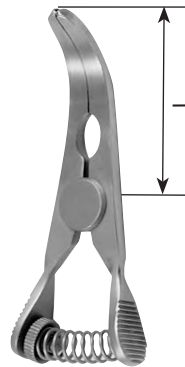
**TITANIUM**  
 4,0 cm, 1<sup>5</sup>/<sub>8</sub>"  
 vena **027-033-40**  
 arteria **027-043-40**

**Bulldogklemmen, Darm- und Gewebefäßzangen**  
**Bulldog Clamps, Intestinal and Tissue Grasping Forceps**  
**Clamps Bulldog, Pinzas intestinales y para tejidos**  
**Pinze Bulldog, Pinze da presa per intestino e tessuti**



		L	
6,8 cm, 2 <sup>3</sup> / <sub>4</sub> "	<b>026-298-07</b>	3,3 cm, 1 <sup>3</sup> / <sub>8</sub> "	
9,6 cm, 3 <sup>3</sup> / <sub>4</sub> "	<b>026-298-09</b>	5,0 cm, 2"	
11,7 cm, 4 <sup>3</sup> / <sub>4</sub> "	<b>026-298-11</b>	6,9 cm, 2 <sup>3</sup> / <sub>4</sub> "	

**GLOVER**



		L	
6,5 cm, 2 <sup>1</sup> / <sub>2</sub> "	<b>026-299-06</b>	3,3 cm, 1 <sup>3</sup> / <sub>8</sub> "	
9,1 cm, 3 <sup>1</sup> / <sub>2</sub> "	<b>026-299-09</b>	5,0 cm, 2"	
11,0 cm, 4 <sup>3</sup> / <sub>8</sub> "	<b>026-299-11</b>	6,9 cm, 2 <sup>3</sup> / <sub>4</sub> "	

**GLOVER**



**CHAPUT**  
 13,0 cm, 5"  
**040-370-13**



**TUFFIER**  
 13,0 cm, 5"  
**040-372-13**



**COLLIN**  
 16,0 cm, 6<sup>1</sup>/<sub>4</sub>"  
**040-376-16**



**PENNINGTON**  
15,5 cm, 6"    **040-358-15**  
20,0 cm, 8"    **040-358-20**



**ATRAUMA**

25,0 cm, 9<sup>3</sup>/<sub>4</sub>"  
**040-658-25**



27,0 cm, 10<sup>1</sup>/<sub>2</sub>"  
**040-658-27**



**MARTEL**  
14,0 cm, 5<sup>1</sup>/<sub>2</sub>"  
**040-364-14**



**WILLET-MARTEL**  
19,0 cm, 7<sup>1</sup>/<sub>2</sub>"  
**040-366-19**

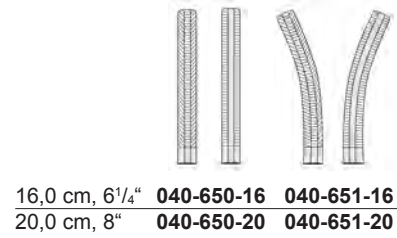
Arterienklemmen  
 Haemostatic Forceps  
 Pinzas hemostáticas  
 Pinze emostatiche



**PRATT**  
 15,0 cm, 6"  
 040-656-15



**FERGUSSON**



16,0 cm, 6 1/4"	<b>040-650-16</b>	<b>040-651-16</b>
20,0 cm, 8"	<b>040-650-20</b>	<b>040-651-20</b>



**CARREL**  
 10,0 cm, 4"  
 040-010-10

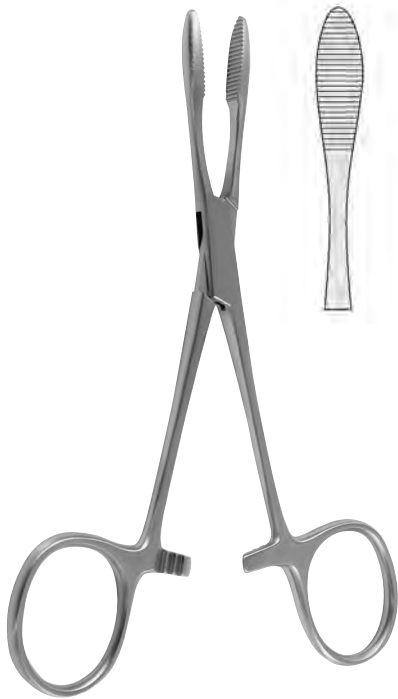


**TERRIER**  
 10,0 cm, 4"  
 040-016-10



**KROENLEIN**  
 13,0 cm, 5"  
 040-369-13





**PEAN**

14,0 cm, 5 1/2" **040-368-14**  
16,0 cm, 6 1/4" **040-368-16**



**BABY-MIXTER**  
14,0 cm, 5 1/2"

**040-475-01**

**040-475-02**



**SPENCER-WELLS**

13,0 cm, 5" **040-290-13** **040-291-13**  
15,0 cm, 6" **040-290-15** **040-291-15**  
18,0 cm, 7" **040-290-18** **040-291-18**  
20,0 cm, 8" **040-290-20** **040-291-20**

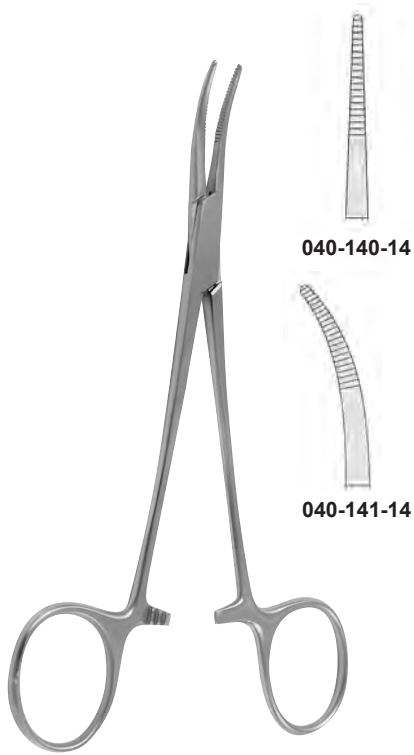


**HARTMANN**  
10,0 cm, 4"

**040-000-10**

**040-001-10**

Arterienklemmen  
Haemostatic Forceps  
Pinzas hemostáticas  
Pinze emostatiche



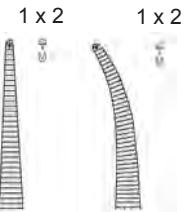
040-140-14

040-141-14

**PROVICENCE-HOSPITAL**  
14,0 cm, 5 1/2"



12,5 cm, 5" **040-050-12** **040-051-12**  
14,0 cm, 9 3/4" **040-050-14** **040-051-14**

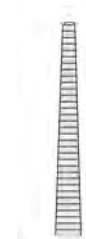


12,5 cm, 5" **040-070-12** **040-071-12**  
14,0 cm, 9 3/4" **040-070-14** **040-071-14**

**HALSTED-MOSQUITO**



**HALSTED-MOSQUITO**



18,0 cm, 7"  
**040-050-18**



18,0 cm, 7"  
**040-051-18**



21,0 cm, 8 1/4"  
**040-050-21**



21,0 cm, 8 1/4"  
**040-051-21**



18,0 cm, 7"  
**040-070-18**



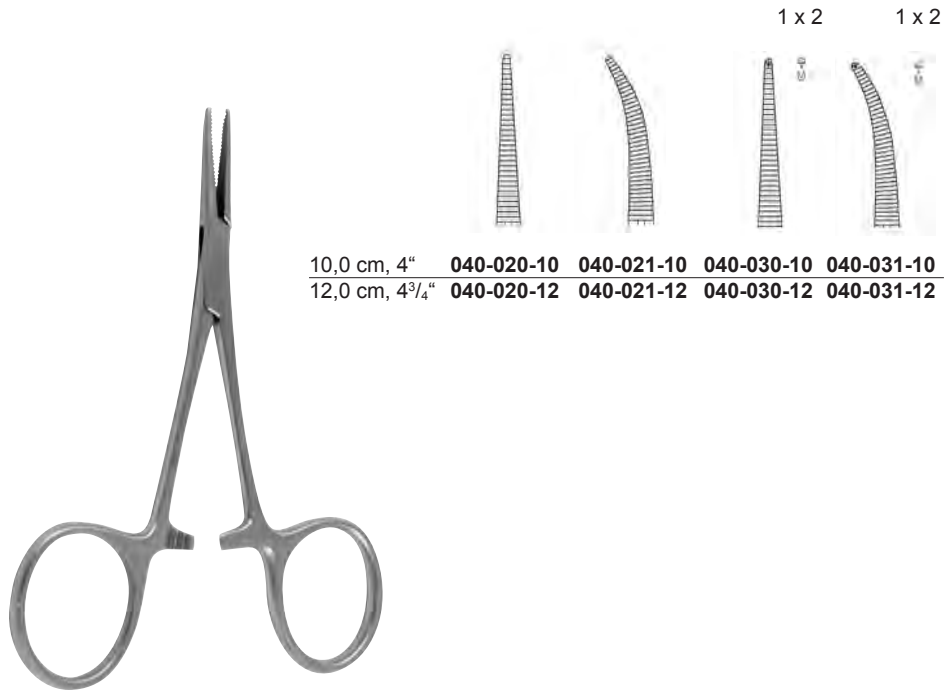
18,0 cm, 7"  
**040-071-18**



21,0 cm, 8 1/4"  
**040-070-21**

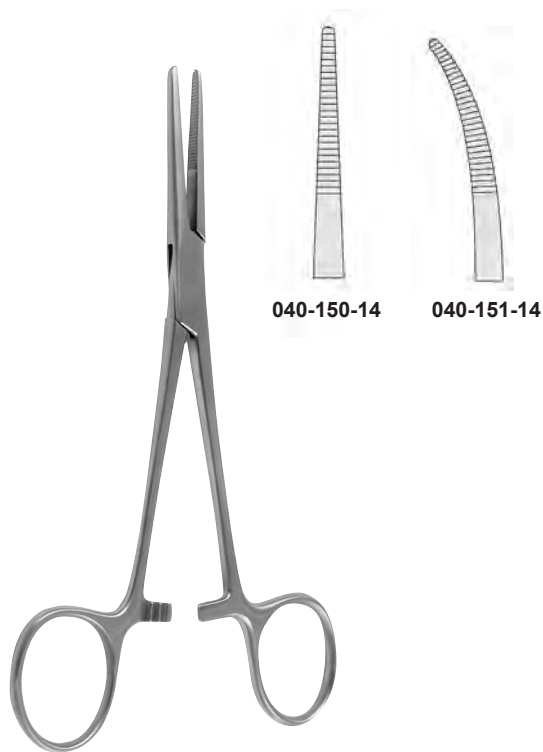


21,0 cm, 8 1/4"  
**040-071-21**



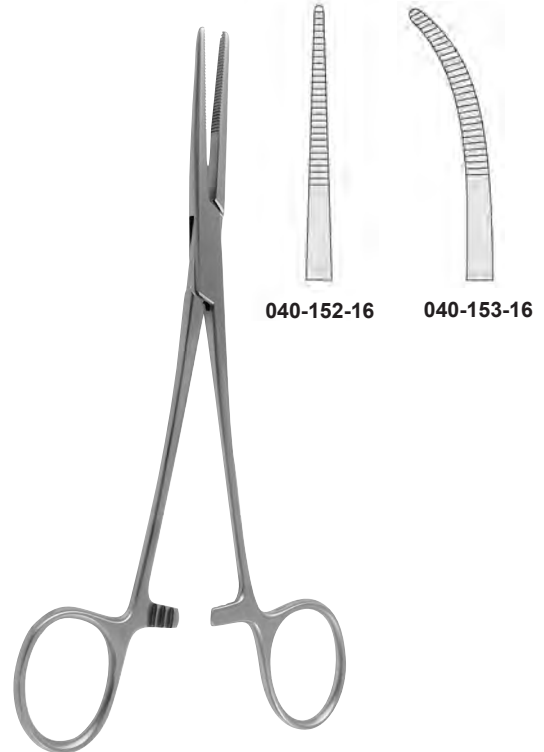
			1 x 2	1 x 2
10,0 cm, 4"	<b>040-020-10</b>	<b>040-021-10</b>	<b>040-030-10</b>	<b>040-031-10</b>
12,0 cm, 4 <sup>3</sup> / <sub>4</sub> "	<b>040-020-12</b>	<b>040-021-12</b>	<b>040-030-12</b>	<b>040-031-12</b>

**MICRO-MOSQUITO**



<b>040-150-14</b>	<b>040-151-14</b>

**KELLY**  
14,0 cm, 5<sup>1</sup>/<sub>2</sub>"



<b>040-152-16</b>	<b>040-153-16</b>

**KELLY-RANKIN**  
16,0 cm, 6<sup>1</sup>/<sub>4</sub>"

Arterienklemmen  
 Haemostatic Forceps  
 Pinzas hemostáticas  
 Pinze emostatiche



**LERICHE**  
 15,0 cm, 6"



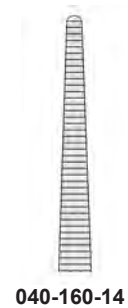
**BABY-OVERHOLT**  
 13,5 cm, 5 1/4"  
 040-424-14

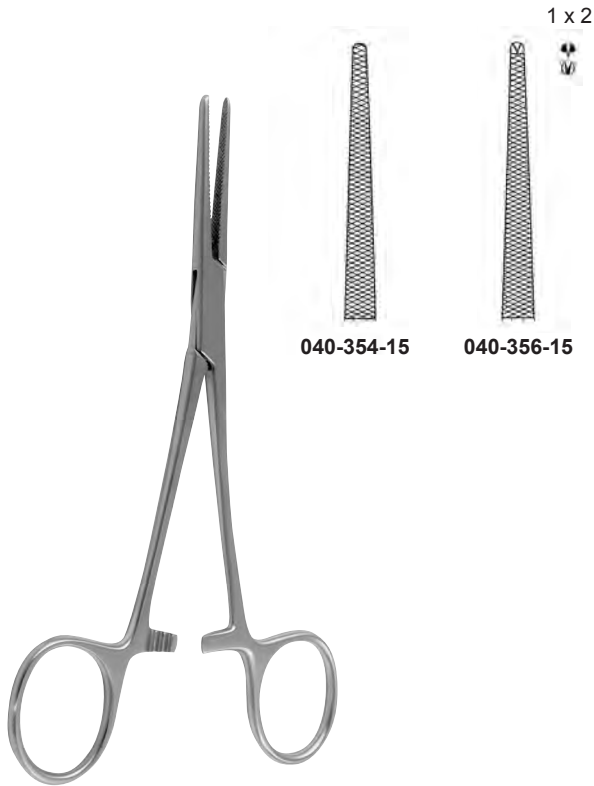


**DANDY**  
 14,0 cm, 5 1/2"

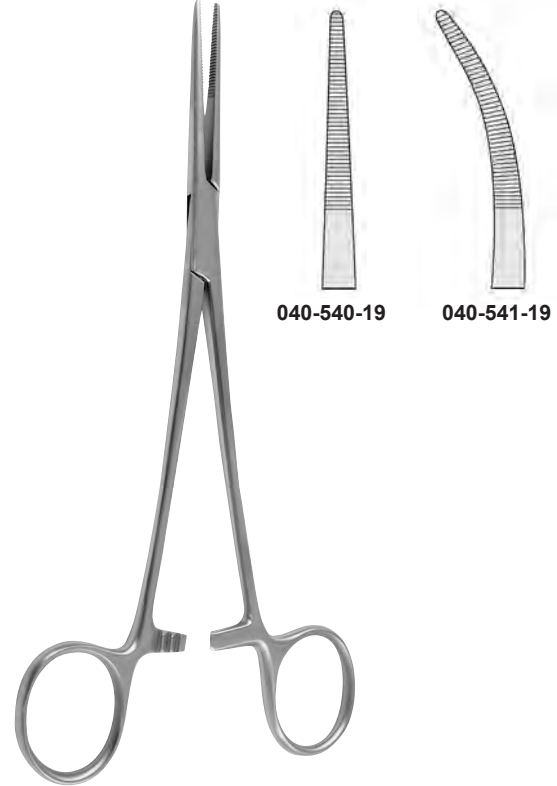


**CRILE**  
 14,0 cm, 5 1/2"

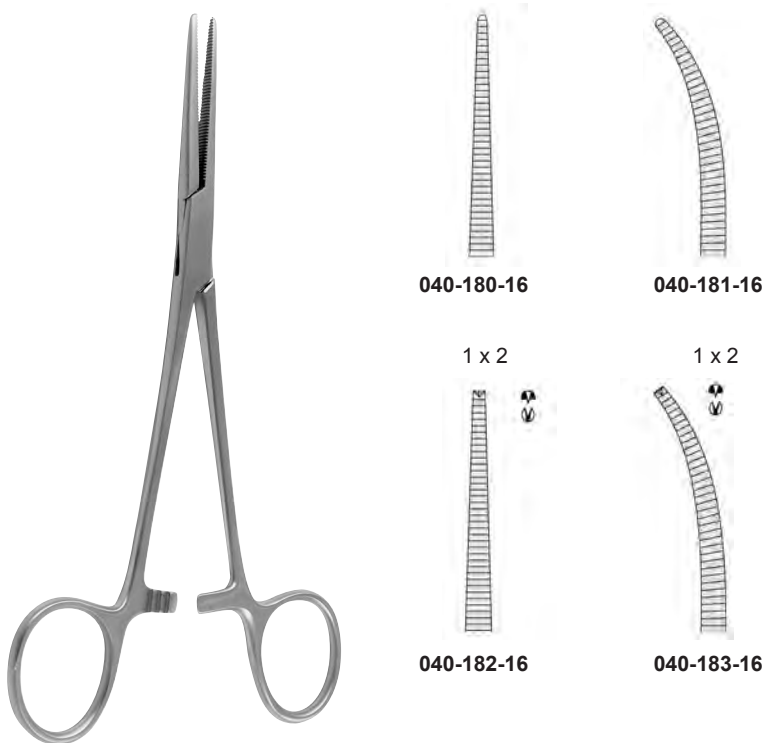




**DIXON-LOVELACE**  
15,0 cm, 6"

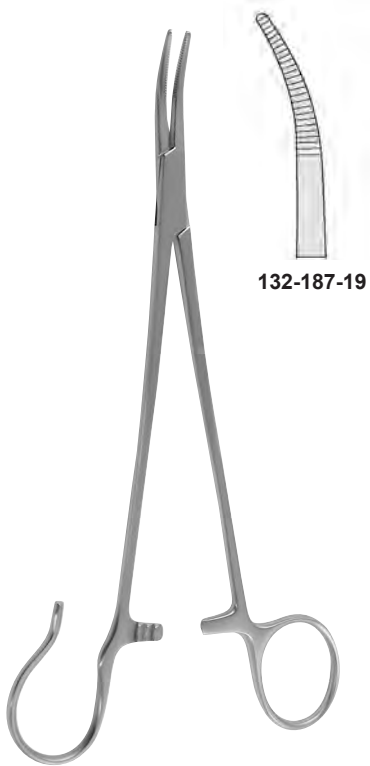


**BIRKETT**  
19,0 cm, 7 1/2"

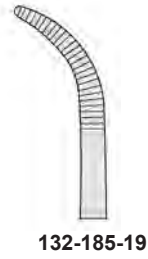


**CRILE-RANKIN**  
16,0 cm, 6 1/4"

Arterienklemmen  
 Haemostatic Forceps  
 Pinzas hemostáticas  
 Pinze emostatiche

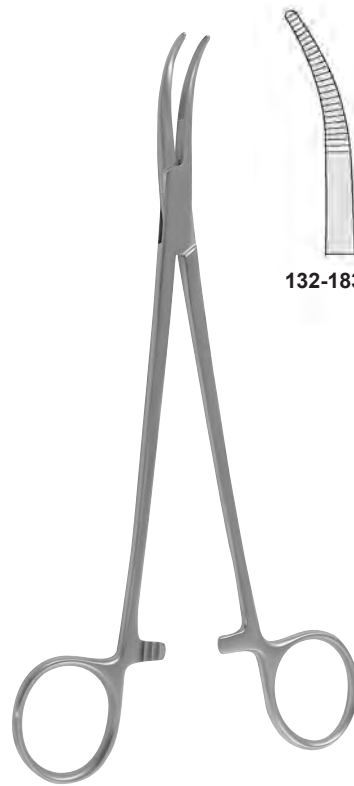


132-187-19



132-185-19

**SCHNIDT**  
 19,0 cm, 7 1/2"



132-183-19

132-181-19

**SCHNIDT-SAWTELL**  
 19,0 cm, 7 1/2"



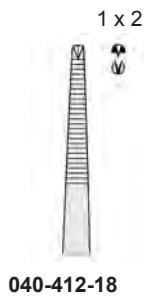
**ADSON**  
 18,5 cm, 7 1/4"



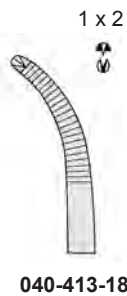
040-414-16



040-415-18



040-412-18



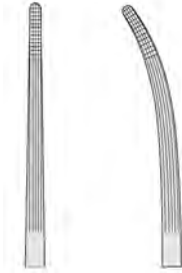
040-413-18



**CRAFOORD**  
 24,0 cm, 9 1/2"  
 040-453-24



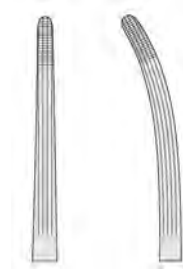
15,0 cm, 6"    **040-480-15**    **040-481-15**  
18,5 cm, 7 1/4"    **040-480-18**    **040-481-18**



**BAINBRIDGE**



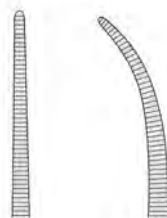
16,0 cm, 6 1/4"    **040-340-16**    **040-341-16**  
20,0 cm, 8"    **040-340-20**    **040-341-20**



**ROCHESTER-CARMALT**



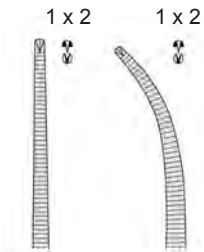
13,0 cm, 5"    **040-262-13**    **040-263-13**  
14,0 cm, 5 1/2"    **040-262-14**    **040-263-14**  
16,0 cm, 6 1/4"    **040-262-16**    **040-263-16**



**PEAN DELICATE**



13,0 cm, 5"    **040-352-13**    **040-353-13**  
14,0 cm, 5 1/2"    **040-352-14**    **040-353-14**  
16,0 cm, 6 1/4"    **040-352-16**    **040-353-16**

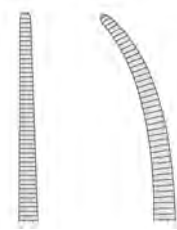


**KOCHER DELICATE**

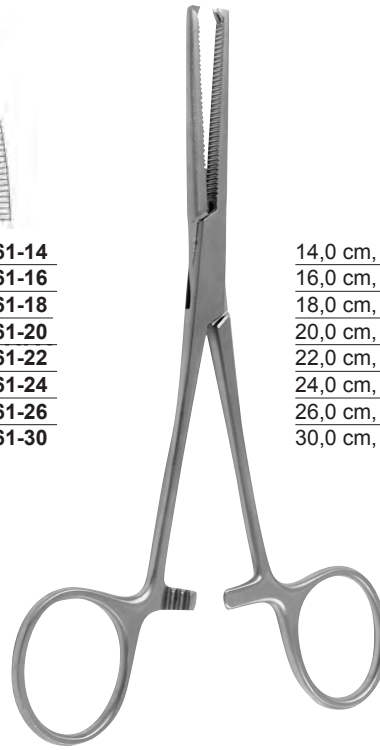
Arterienklemmen  
Haemostatic Forceps  
Pinzas hemostáticas  
Pinze emostatiche



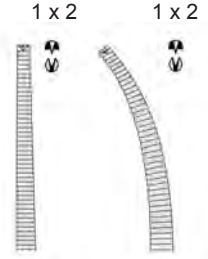
**ROCHESTER-PEAN**



14,0 cm, 5 1/2"	<b>040-260-14</b>	<b>040-261-14</b>
16,0 cm, 6 1/4"	<b>040-260-16</b>	<b>040-261-16</b>
18,0 cm, 7"	<b>040-260-18</b>	<b>040-261-18</b>
20,0 cm, 8"	<b>040-260-20</b>	<b>040-261-20</b>
22,0 cm, 8 5/8"	<b>040-260-22</b>	<b>040-261-22</b>
24,0 cm, 9 1/2"	<b>040-260-24</b>	<b>040-261-24</b>
26,0 cm, 10 1/4"	<b>040-260-26</b>	<b>040-261-26</b>
30,0 cm, 12"	<b>040-260-30</b>	<b>040-261-30</b>



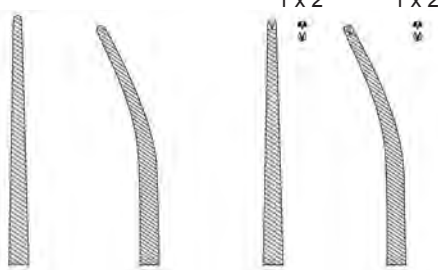
**KOCHER-OCHSNER**



14,0 cm, 5 1/2"	<b>040-350-14</b>	<b>040-351-14</b>
16,0 cm, 6 1/4"	<b>040-350-16</b>	<b>040-351-16</b>
18,0 cm, 7"	<b>040-350-18</b>	<b>040-351-18</b>
20,0 cm, 8"	<b>040-350-20</b>	<b>040-351-20</b>
22,0 cm, 8 5/8"	<b>040-350-22</b>	<b>040-351-22</b>
24,0 cm, 9 1/2"	<b>040-350-24</b>	<b>040-351-24</b>
26,0 cm, 10 1/4"	<b>040-350-26</b>	<b>040-351-26</b>
30,0 cm, 12"	<b>040-350-30</b>	<b>040-351-30</b>

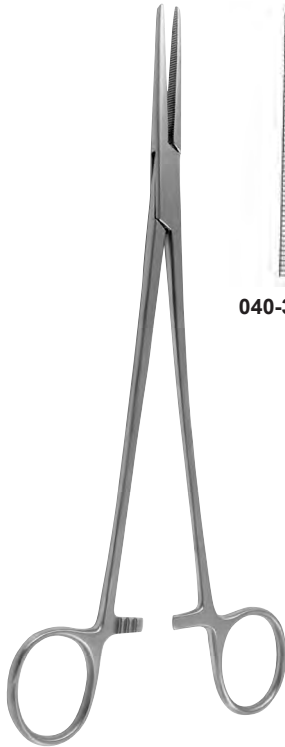


**BENGOLEA**



20,0 cm, 8"	<b>040-384-20</b>	<b>040-385-20</b>	<b>040-386-20</b>	<b>040-387-20</b>
26,0 cm, 10 1/4"	<b>040-384-26</b>	<b>040-385-26</b>	<b>040-386-26</b>	<b>040-387-26</b>





040-390-20

040-391-20

040-393-20

**HEISS**  
20,0 cm, 8"



040-448-22

040-449-22

**ROBERTS**  
22,0 cm, 8<sup>5</sup>/<sub>8</sub>"



040-450-24

040-451-24

**SAROT**  
24,0 cm, 9<sup>1</sup>/<sub>2</sub>"



040-533-01

040-533-02

**NEGUS**  
19,0 cm, 7<sup>1</sup>/<sub>2</sub>"



14,0 cm, 5½"    040-411-14  
 18,0 cm, 7"    040-411-18

**BABY-ADSON**



**MICRO-ADSON**  
 14,0 cm, 5½"  
 040-409-14



**BABY-MIXTER**  
 18,0 cm, 7"  
 040-475-18



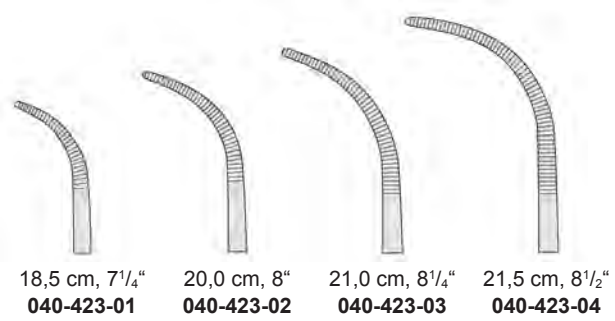
**OVERHOLT-MIXTER**  
 21,0 cm, 8¼"  
 040-471-21



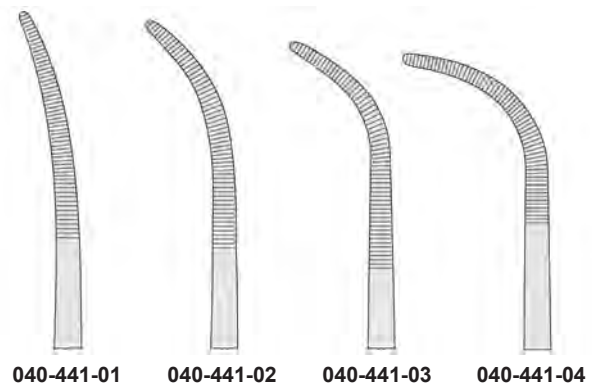
**JOHNS HOPKINS**  
 20,0 cm, 8"  
 040-497-20



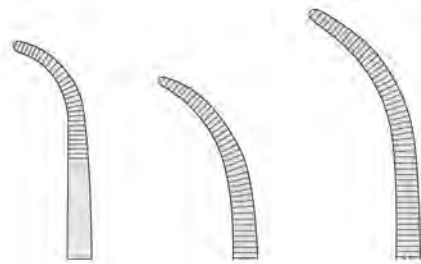
**OVERHOLT**



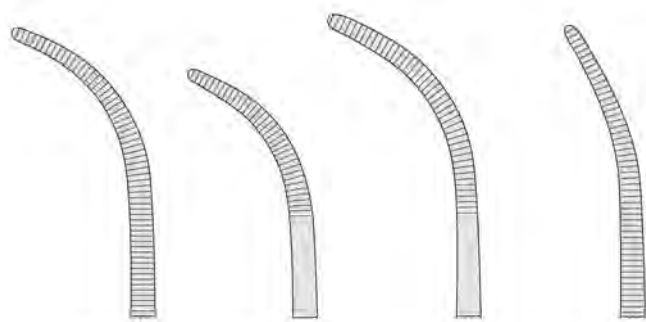
**RUMEL**  
23,0 cm, 9"



Präparier- und Ligaturklemmen  
 Dissecting and Ligature Forceps  
 Pinzas de disección y ligaduras  
 Pinze per preparazioni e legature



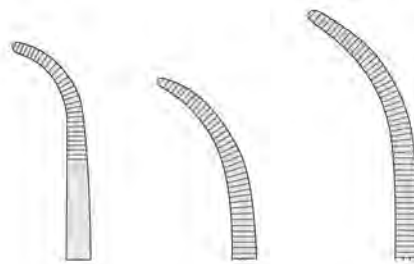
**040-421-01** 20,5 cm, 7<sup>3</sup>/<sub>4</sub>"  
**040-421-02** 20,0 cm, 7<sup>1</sup>/<sub>2</sub>"  
**040-421-03** 21,5 cm, 8<sup>1</sup>/<sub>4</sub>"



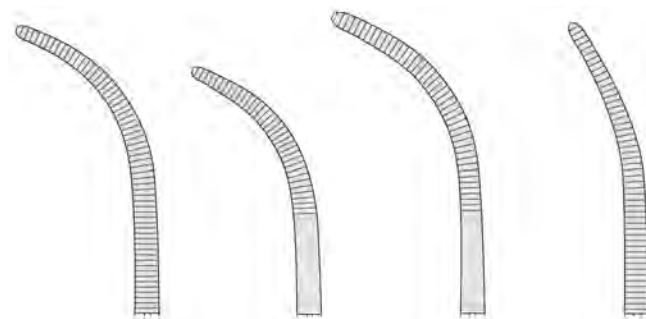
**040-421-04** 22,0 cm, 8<sup>3</sup>/<sub>4</sub>"  
**040-421-05** 21,5 cm, 8<sup>1</sup>/<sub>2</sub>"  
**040-421-06** 22,0 cm, 8<sup>3</sup>/<sub>4</sub>"  
**040-421-07** 22,0 cm, 8<sup>3</sup>/<sub>4</sub>"



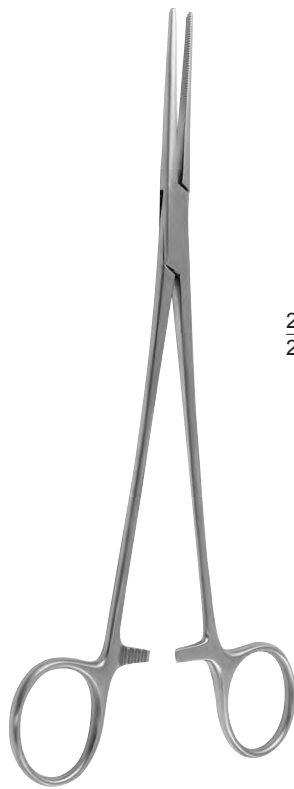
**OVERHOLT-GEISSENDOERFER**



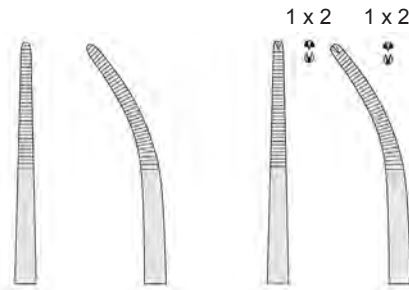
**040-422-01** 27,0 cm, 10<sup>3</sup>/<sub>4</sub>"  
**040-422-02** 26,0 cm, 10<sup>1</sup>/<sub>4</sub>"  
**040-422-03** 27,0 cm, 10<sup>3</sup>/<sub>4</sub>"



**040-422-04** 27,5 cm, 10<sup>3</sup>/<sub>4</sub>"  
**040-422-05** 27,5 cm, 10<sup>3</sup>/<sub>4</sub>"  
**040-422-06** 28,0 cm, 11"  
**040-422-07** 28,0 cm, 11"



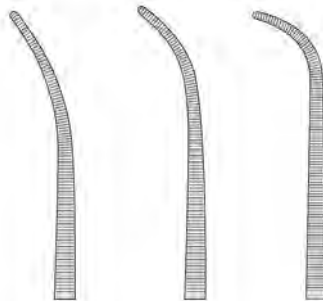
**TOENNIS**



21,0 cm, 8 <sup>1</sup> / <sub>4</sub> "	<b>040-442-21</b>	<b>040-443-21</b>	<b>040-444-21</b>	<b>040-445-21</b>
26,0 cm, 10 <sup>1</sup> / <sub>4</sub> "	<b>040-442-26</b>	<b>040-443-26</b>	<b>040-444-26</b>	<b>040-445-26</b>



**KELLY**



19,0 cm, 7 <sup>1</sup> / <sub>2</sub> "	<b>040-463-19</b>	<b>040-465-19</b>	<b>040-467-19</b>
22,0 cm, 8 <sup>5</sup> / <sub>8</sub> "	<b>040-463-22</b>	<b>040-465-22</b>	<b>040-467-22</b>
24,0 cm, 9 <sup>1</sup> / <sub>2</sub> "	<b>040-463-24</b>	<b>040-465-24</b>	<b>040-467-24</b>

Präparier- und Ligaturklemmen  
 Dissecting and Ligature Forceps  
 Pinzas de disección y ligaduras  
 Pinze per preparazioni e legature



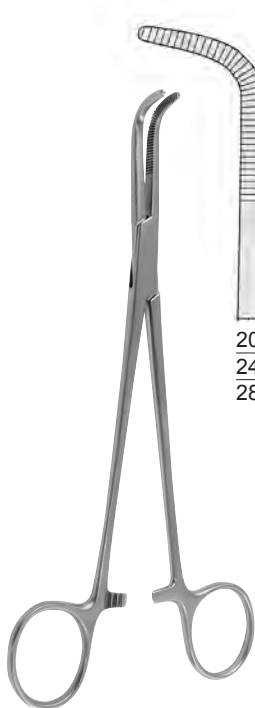
18,0 cm, 7"	<b>040-429-18</b>
22,0 cm, 8 <sup>5</sup> / <sub>8</sub> "	<b>040-429-22</b>
25,0 cm, 9 <sup>3</sup> / <sub>4</sub> "	<b>040-429-25</b>
28,0 cm, 11"	<b>040-429-28</b>

**MINI-GEMINI**



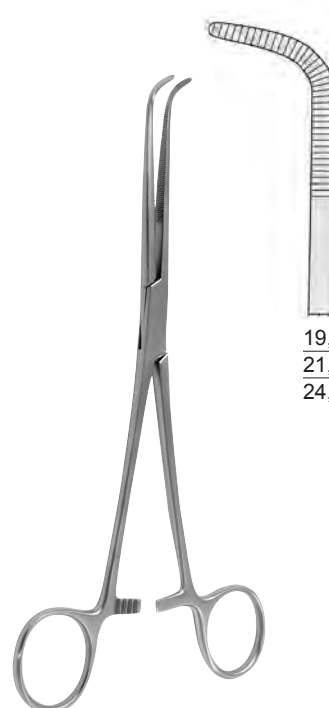
14,0 cm, 5 <sup>1</sup> / <sub>2</sub> "	<b>040-431-14</b>
16,0 cm, 6 <sup>1</sup> / <sub>4</sub> "	<b>040-431-16</b>
18,0 cm, 7"	<b>040-431-18</b>
20,0 cm, 8"	<b>040-431-20</b>
23,0 cm, 9"	<b>040-431-23</b>
25,0 cm, 9 <sup>3</sup> / <sub>4</sub> "	<b>040-431-25</b>
28,0 cm, 11"	<b>040-431-28</b>

**GEMINI**



20,0 cm, 8"	<b>040-433-20</b>
24,0 cm, 9 <sup>1</sup> / <sub>2</sub> "	<b>040-433-24</b>
28,0 cm, 11"	<b>040-433-28</b>

**KANTROWITZ**



19,0 cm, 7 <sup>1</sup> / <sub>2</sub> "	<b>040-543-19</b>
21,0 cm, 8 <sup>1</sup> / <sub>4</sub> "	<b>040-543-21</b>
24,0 cm, 9 <sup>1</sup> / <sub>2</sub> "	<b>040-543-24</b>

**WIKSTROEM**



**MIXTER**  
15,5 cm, 6" **040-461-15**  
19,0 cm, 7½" **040-461-19**



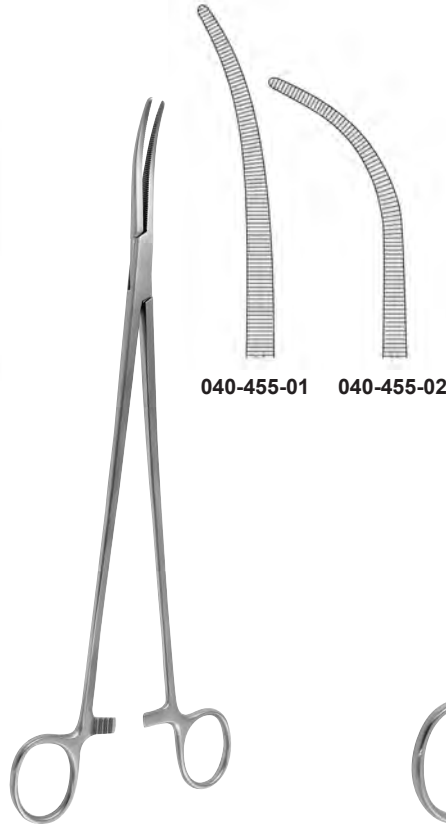
**MIXTER-O'SHAUGNESSY**  
15,5 cm, 6" **040-477-15**  
19,0 cm, 7½" **040-477-19**



**MIXTER**  
22,0 cm, 8¾" **040-473-22**



**MIXTER**  
23,0 cm, 9" **040-473-23**



**ZENKER**

**040-455-01 040-455-02**



**ZENKER**

**040-459-18 040-459-28**

Präparier- und Ligaturklemmen  
 Dissecting and Ligature Forceps  
 Pinzas de disección y ligaduras  
 Pinze per preparazioni e legature

1 x 2



**LAWRENCE**  
 27,5 cm, 10<sup>3</sup>/<sub>4</sub>"  
 040-457-28



**HOSEMANN**  
 21,0 cm, 8<sup>1</sup>/<sub>4</sub>"



**DESJARDINS**  
 21,0 cm, 8<sup>1</sup>/<sub>4</sub>"  
 040-529-21



**MIXTER**  
 22,0 cm, 8<sup>3</sup>/<sub>4</sub>" **040-479-22**  
 25,0 cm, 9<sup>3</sup>/<sub>4</sub>" **040-479-25**  
 28,0 cm, 11" **040-479-28**



**LAHEY**  
 19,0 cm, 7<sup>1</sup>/<sub>2</sub>" **040-501-19**  
 23,0 cm, 9" **040-501-23**

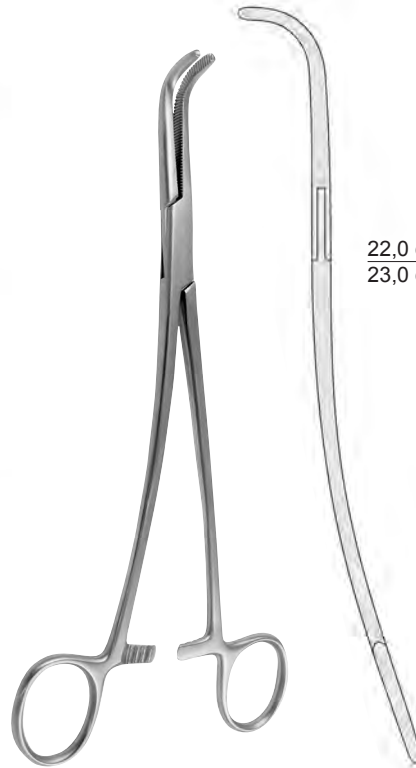


**LOWER**  
 18,0 cm, 7"  
**040-503-18**

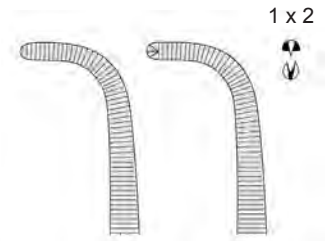




**MC QUIGG-MIXTER**  
22,0 cm, 8<sup>3</sup>/<sub>4</sub>"  
040-507-22



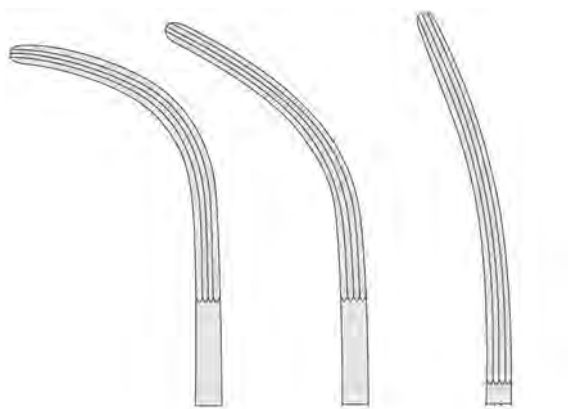
**GRAY**



22,0 cm, 8<sup>3</sup>/<sub>4</sub>" 040-523-22 040-525-22  
23,0 cm, 9" 040-523-23 040-525-23



**CRAFOORD-SELLORS**



22,0 cm, 8<sup>3</sup>/<sub>4</sub>" 040-456-22  
23,0 cm, 9" 040-456-23  
24,0 cm, 9<sup>1</sup>/<sub>2</sub>" 040-456-24



**FINOCCHIETTO**  
24,0 cm, 9<sup>1</sup>/<sub>2</sub>"  
040-505-24

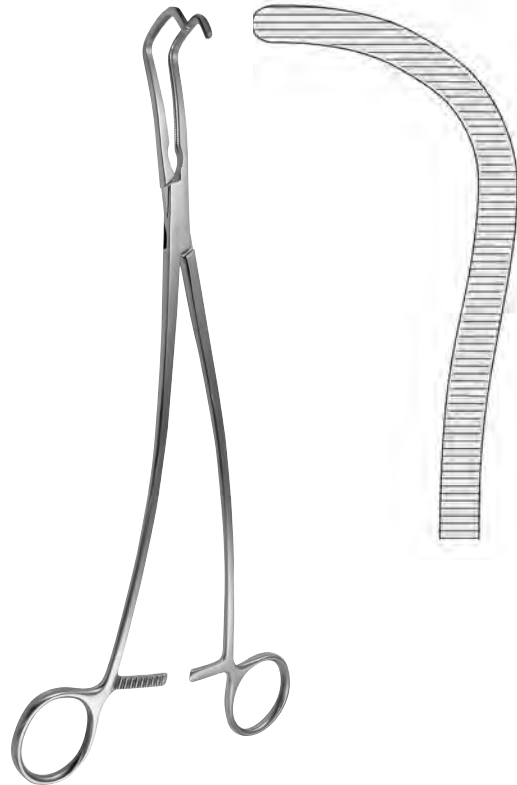


**Gallenkanal- und Nierenstielklemmen**  
**Gall Duct and Kidney Pedicle Clamps**  
**Pinzas-clamps para pedúnculo renal**  
**Pinze per peduncoli renali**



**GUYON**

20,0 cm, 8" **040-509-20**  
22,0 cm, 8<sup>3</sup>/<sub>4</sub>" **040-509-22**  
24,0 cm, 9<sup>1</sup>/<sub>2</sub>" **040-509-24**



**GUYON**

23,0 cm, 9"  
**040-513-23**



**GUYON**

23,0 cm, 9"  
**158-519-23**

24,0 cm, 9<sup>1</sup>/<sub>2</sub>"  
**158-519-24**



**STILLE**  
23,0 cm, 9"  
**040-511-23**



**HERRICK**  
23,0 cm, 9"  
040-517-23



**URO-TANGENTIAL**

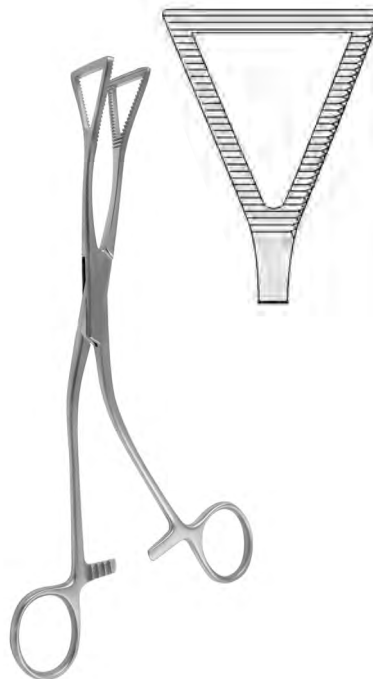


23,0 cm, 9"  
170-055-01

24,0 cm, 9 1/2"  
170-055-02



**LOVELACE**  
20,0 cm, 8"  
141-004-20



**LOVELACE**  
20,0 cm, 8"  
141-005-20



**PRICE-THOMAS**  
22,0 cm, 8 3/4"  
141-001-22

Bronchusklemmen, Peritoneumklemmen, Hysterektomieklemmen  
 Bronchus Forceps, Peritoneum Forceps, Hysterectomy Forceps  
 Pinzas-clamps para bronquios, Pinzas-clamps para peritoneo y para histerectomía  
 Pinze per legature, Pinze per peritoneo e per isterectomia



**PRICE-THOMAS**  
 22,0 cm, 8<sup>3</sup>/<sub>4</sub>"



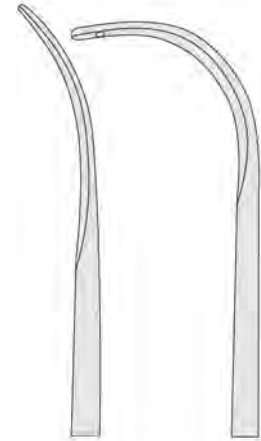
141-002-01



141-002-02



**SEMB**  
 24,0 cm, 9<sup>1</sup>/<sub>2</sub>"

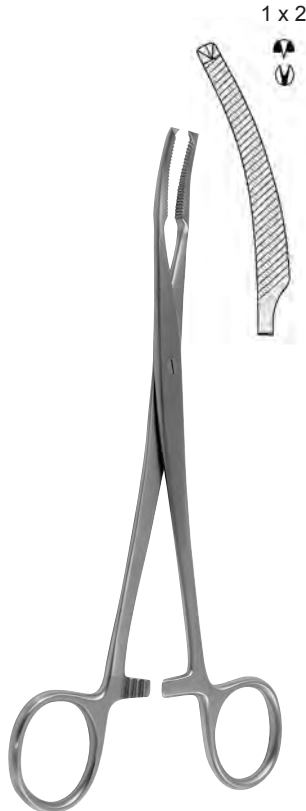


141-003-01

141-003-02



**BABY-MIKULICZ**  
 14,0 cm, 5<sup>1</sup>/<sub>2</sub>"  
 040-701-14



**MIKULICZ**  
 18,0 cm, 7"  
 040-703-18



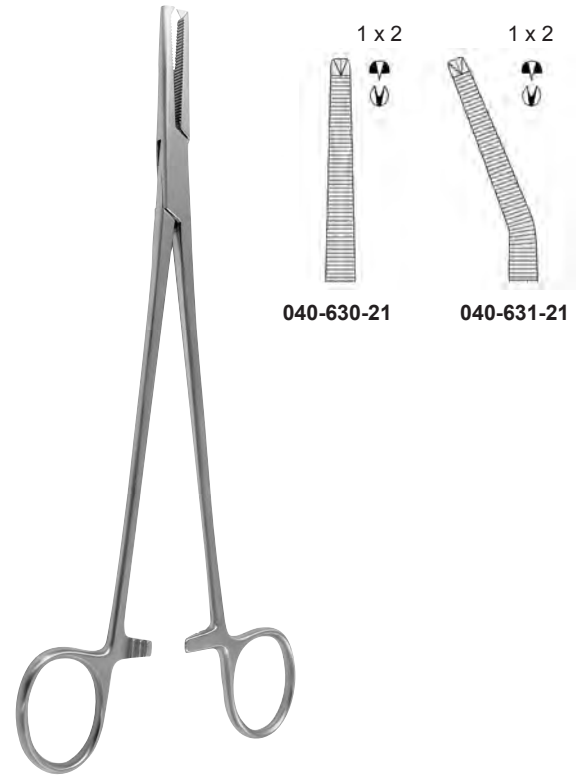
**MIKULICZ**  
 20,0 cm, 8"  
 040-709-20



040-721-20

040-723-20

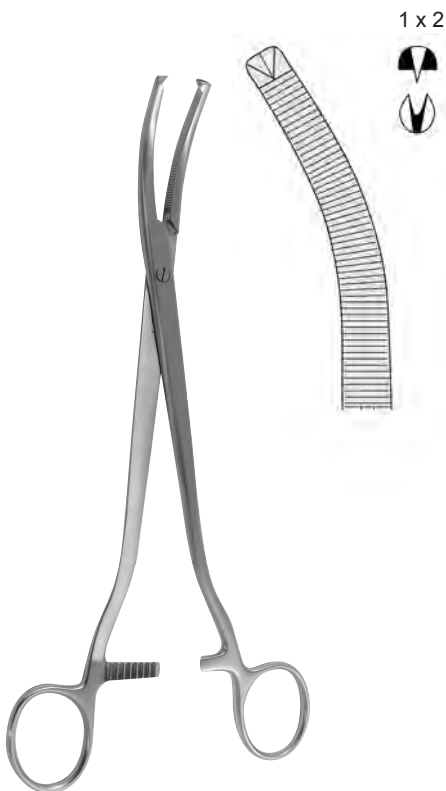
**FAURE**  
20,0 cm, 8"



040-630-21

040-631-21

**PHANEUF**  
21,5 cm, 8 1/2"

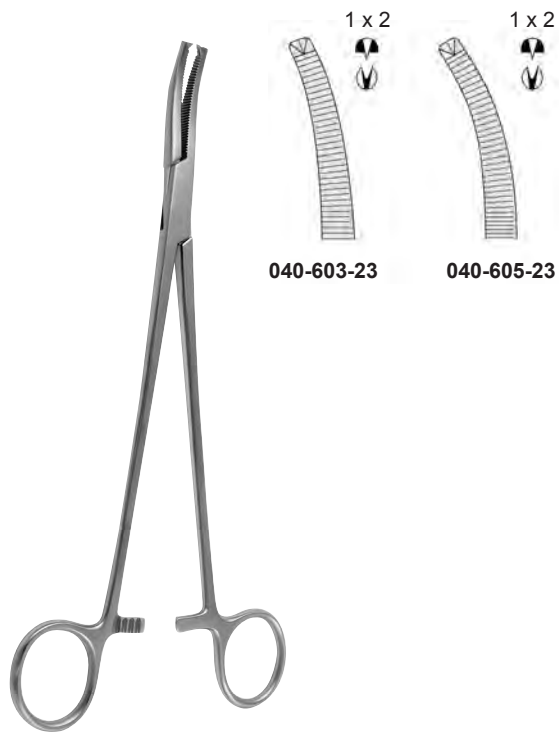


**WERTHEIM**  
24,0 cm, 9 1/2"  
040-601-24



**WERTHEIM**  
25,0 cm, 10"  
040-602-25

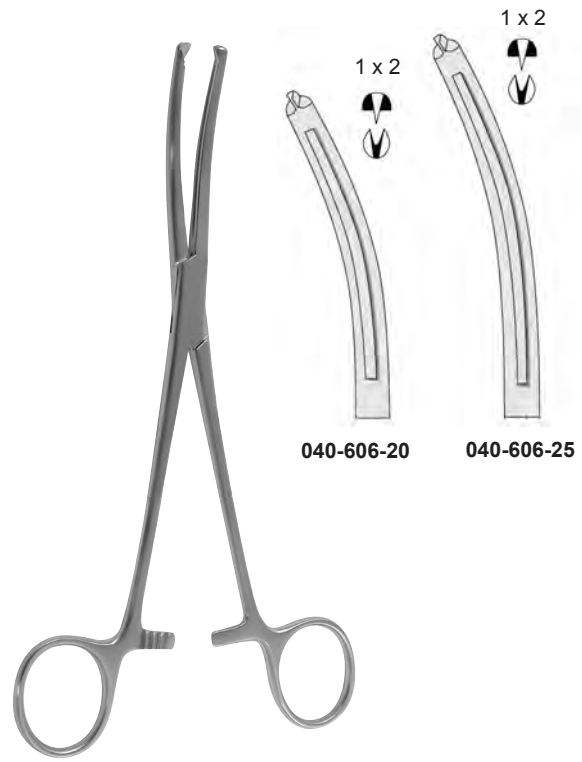
Hysterektomieklemmen  
 Hysterectomy Forceps  
 Pinzas-clamps para histerectomía  
 Pinze per isterectomia



040-603-23

040-605-23

**WERTHEIM**  
 23,0 cm, 9"



040-606-20

040-606-25

**MAINGOT**  
 21,5 cm, 8 1/2"



23,0 cm, 9"  
 040-625-23

24,0 cm, 9 1/2"  
 040-627-24

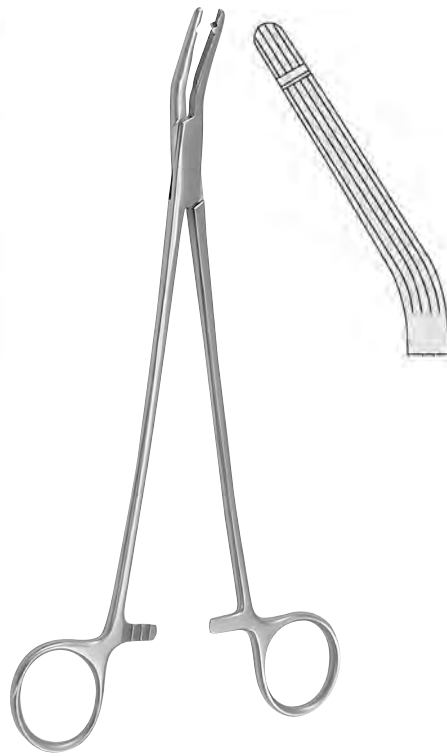
**MOYNIHAN**



**WERTHEIM-CULLEN**  
 21,5 cm, 8 1/2"  
 040-629-21



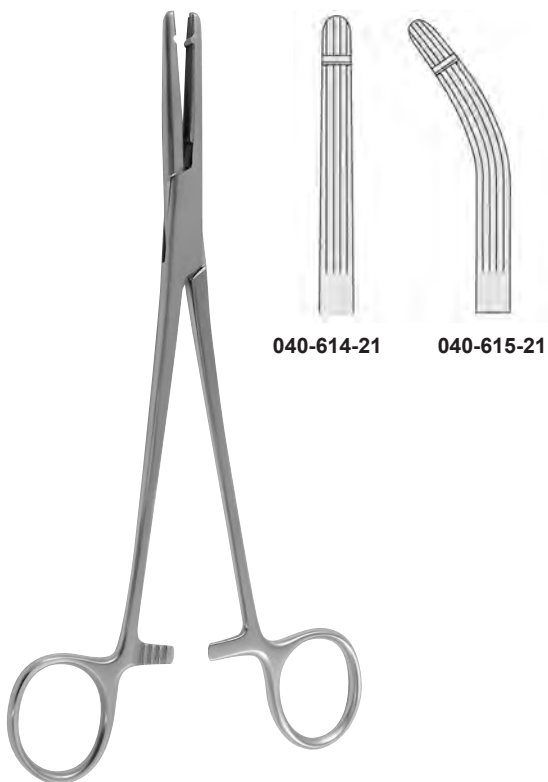
**LONG**  
19,0 cm, 7 1/4"  
040-621-19



**GARLAND**  
21,0 cm, 8 1/4"  
040-623-21



**HEANEY**  
21,0 cm, 8 1/4"  
040-607-21



**HEANEY-BALLANTINE**  
21,0 cm, 8 1/4"

040-614-21

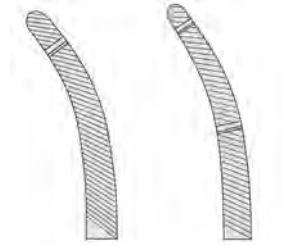
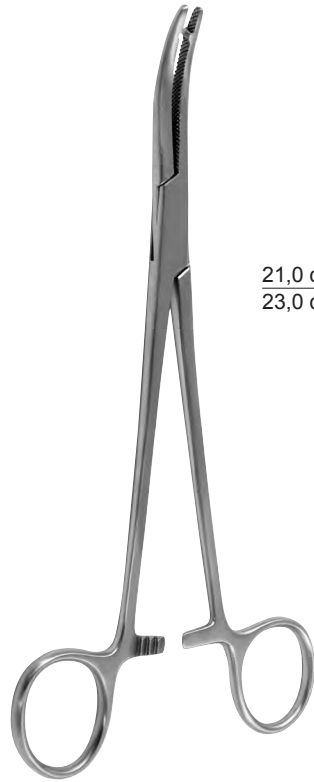
040-615-21



**HEANEY-KANTER**  
21,0 cm, 8 1/4"

040-617-21

Hysterektomieklemmen  
Hysterectomy Forceps  
Pinzas-clamps para hysterectomía  
Pinze per isterectomia



21,0 cm, 8 <sup>1</sup> / <sub>4</sub> "	<b>040-611-21</b>	<b>040-613-21</b>
23,0 cm, 9"	<b>040-611-23</b>	<b>040-613-23</b>

**HEANEY**



**Nahtinstrumente**  
**Suture Instruments**  
**Instrumentos para sutura**  
**Strumenti per sutura**



**DERF**



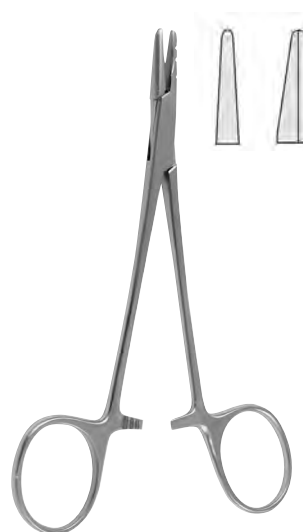
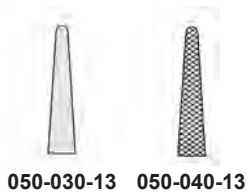
**COLLIER**  
12,5 cm, 5"  
**050-022-12**



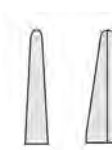
**WEBSTER**  
13,0 cm, 5"  
**050-028-13**



**HALSEY**  
13,0 cm, 5"



**NEIVERT**  
13,0 cm, 5"  
**050-046-13**



**HEGAR-BAUMGARTNER**  
14,0 cm, 5<sup>1</sup>/<sub>2</sub>"  
**050-048-14**





**050-096-13**  
13,0 cm, 5"

**BROWN**



**CRILE-MURRAY**  
15,0 cm, 6"  
**050-070-15**



**050-060-15**  
15,0 cm, 6"

**CRILE-WOOD**



**ADSON**  
18,0 cm, 7"  
**050-192-18**



**METZENBAUM**  
18,0 cm, 7"  
**050-190-18**

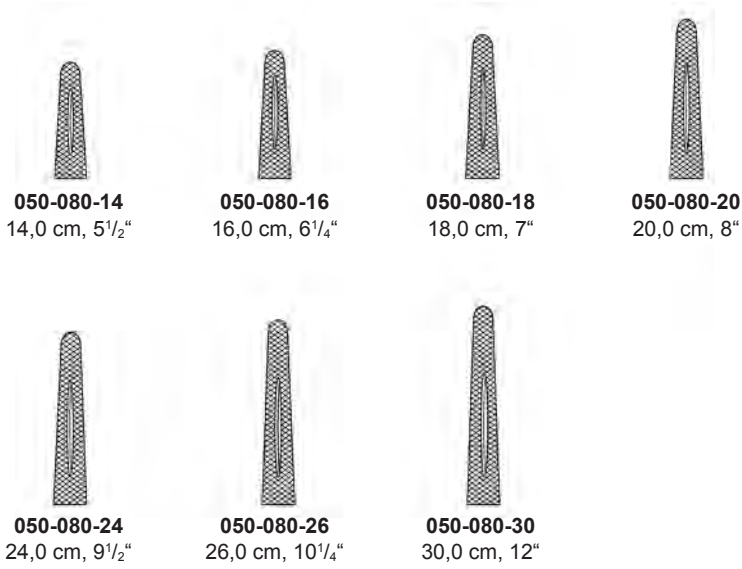


**MASS.-GENERAL-HOSPITAL**  
17,0 cm, 6<sup>3</sup>/<sub>4</sub>"  
**050-072-17**

Nadelhalter  
Needle Holders  
Porta-agujas  
Portaghi



**MAYO-HEGAR**



**MAYO-HEGAR-DELICATE**



**LAWRENCE**  
15,0 cm, 6"  
**050-110-15**



**HEANEY**  
21,0 cm, 8<sup>1</sup>/<sub>4</sub>"  
050-141-21



**JAMISON**  
23,5 cm, 9<sup>1</sup>/<sub>4</sub>"  
050-148-23



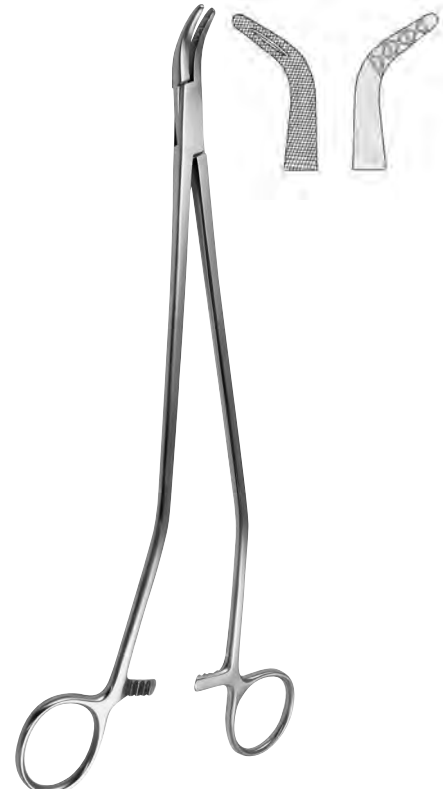
**MASSON**  
27,0 cm, 10<sup>1</sup>/<sub>2</sub>"  
050-150-27



**FINOCCHIETTO**  
27,0 cm, 10<sup>1</sup>/<sub>2</sub>"  
050-211-27



**WANGENSTEEN**  
27,0 cm, 10<sup>1</sup>/<sub>2</sub>"  
050-160-27



**JOHNSON**  
27,0 cm, 10<sup>1</sup>/<sub>2</sub>"  
050-193-27

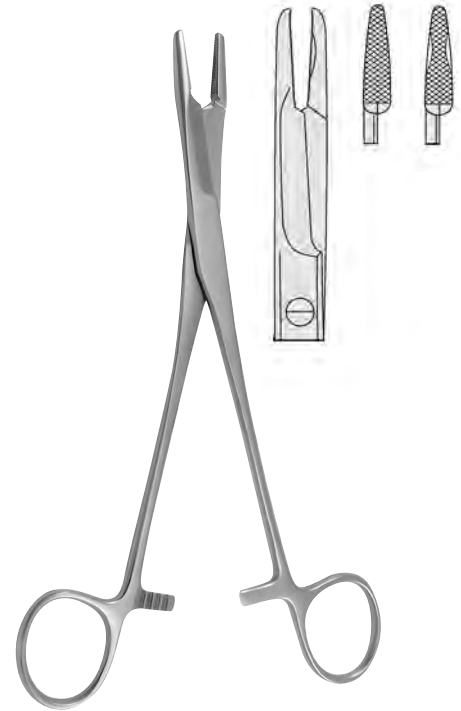
Nadelhalter  
Needle Holders  
Porta-agujas  
Portaghi



**STRATTE**  
23,0 cm, 9"  
050-230-23



**OLSEN-HEGAR**  
17,0 cm, 6<sup>3</sup>/<sub>4</sub>"  
050-310-17



**OLSEN-HEGAR**  
14,0 cm, 5<sup>1</sup>/<sub>2</sub>"  
050-306-14



**OLSEN-HEGAR**

14,0 cm, 5<sup>1</sup>/<sub>2</sub>"  
050-310-14



18,0 cm, 7"  
050-310-18



**TOENNIS**  
18,0 cm, 7"  
050-362-18



**050-350-14**  
14,0 cm, 5½"



**050-350-17**  
17,0 cm, 6¾"



**050-350-20**  
20,0 cm, 8"

**MATHIEU**



**050-356-17**  
17,0 cm, 6¾"

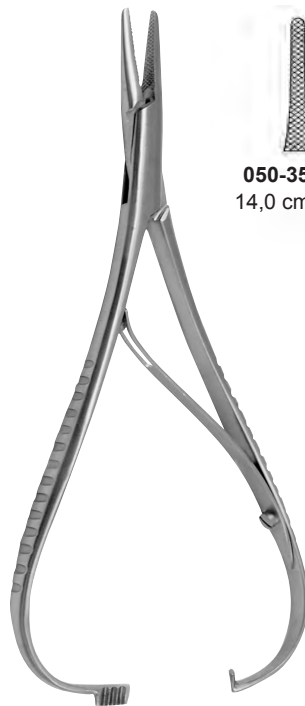


**050-356-20**  
20,0 cm, 8"

**MATHIEU**



**LICHTENBERG**  
20,0 cm, 8"  
**050-366-20**



**050-354-14**  
14,0 cm, 5½"



**050-354-17**  
17,0 cm, 6¾"

**MATHIEU**

Nadelhalter, Mikro-Nadelhalter  
 Needle Holders, Micro Needle Holders  
 Porta-agujas, Micro Porta-agujas  
 Portaghi, Micro Portaghi



**050-358-14**  
 14,0 cm, 5½"



**050-358-17**  
 17,0 cm, 6¾"



**050-358-20**  
 20,0 cm, 8"



**MATHIEU-KOCHER**



**050-550-10**

**050-551-10**



**BARRAQUER-TROUTMAN**  
 10,0 cm, 4"



**050-553-10** **050-553-13**



**BARRAQUER**



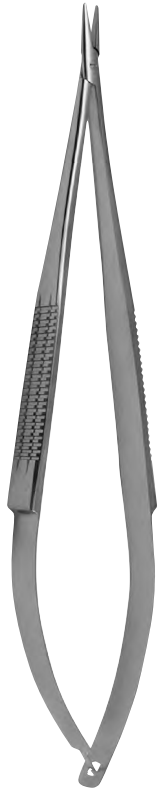
**BARRAQUER**  
 13,5 cm, 5⅜"  
**050-621-13**



**GOMEL**  
 14,0 cm, 5½"  
**050-601-14**







**050-600-18**



**050-601-18**



ohne Sperre  
without ratchet  
sin cremallera  
senza cremagliera

18,5 cm, 7 1/4"



**050-630-18**



**050-631-18**



mit Sperre  
with ratchet  
con cremallera  
con cremagliera

18,5 cm, 7 1/4"



**050-570-14**



**050-571-14**



**050-576-14**



**050-577-14**



mit Sperre  
with ratchet  
con cremallera  
con cremagliera

**CASTROVIEJO**  
14,5 cm, 5 3/4"



**050-570-18**



**050-571-18**



**050-576-18**



**050-577-18**



mit Sperre  
with ratchet  
con cremallera  
con cremagliera

**CASTROVIEJO**  
18,0 cm, 7"

**Mikro-Nadelhalter**  
**Micro Needle Holders**  
**Micro Porta-agujas**  
**Micro Portaghi**

gerade, ohne Sperre  
 straight, without ratchet  
 recta, sin cremallera  
 retta, senza cremagliera

0,4 mm



14,0 cm, 5 1/2"  
**050-650-14**

gebogen, ohne Sperre  
 curved, without ratchet  
 curva, sin cremallera  
 curva, senza cremagliera

0,4 mm



14,0 cm, 5 1/2"  
**050-651-14**

gebogen, mit Sperre  
 curved, with ratchet  
 curva, con cremallera  
 curva, con cremagliera

0,4 mm



14,0 cm, 5 1/2"  
**050-653-14**

gebogen, ohne Sperre  
 curved, without ratchet  
 curva, sin cremallera  
 curva, senza cremagliera

0,5 mm



14,0 cm, 5 1/2"  
**050-661-14**

gebogen, mit Sperre  
 curved, with ratchet  
 curva, con cremallera  
 curva, con cremagliera

0,5 mm



Ø 10 mm

14,0 cm, 5 1/2"  
**050-663-14**

gebogen, ohne Sperre  
 curved, without ratchet  
 curva, sin cremallera  
 curva, senza cremagliera

0,4 mm



Ø 8 mm

13,0 cm, 5"  
**050-671-13**



**IZIAL DENTAL SURGICAL**  
Manufacturer And Exporter Of Surgical Dental & Manicure

Nadelhalter mit Hartmetalleinlagen  
Needle Holders with tungsten carbide inserts  
Porta-agujas con bocas de carburo tungsteno  
Portaghi con morsi in carburo di tungsteno



**KALT**  
13,5 cm, 5<sup>3</sup>/<sub>8</sub>"  
051-428-14



**DIETRICH**

16,0 cm, 5<sup>3</sup>/<sub>8</sub>" **051-250-16**  
18,0 cm, 7" **051-250-18**  
20,0 cm, 8" **051-250-20**  
23,0 cm, 9" **051-250-23**  
26,0 cm, 10<sup>1</sup>/<sub>4</sub>" **051-250-26**



**WEBSTER**  
13,0 cm, 5"  
051-028-13



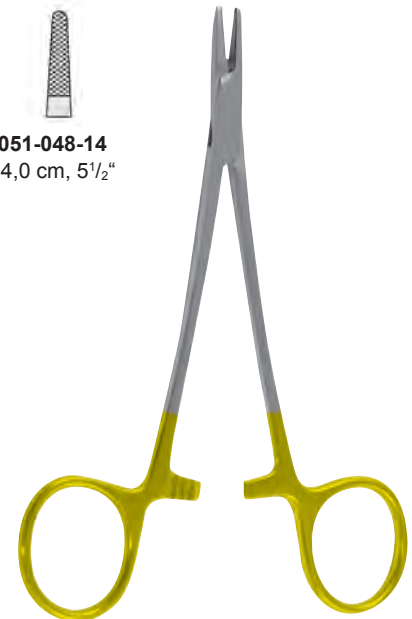
**DERF**  
12,0 cm, 4<sup>3</sup>/<sub>4</sub>"  
051-010-12



**HEGAR-BAUMGARTNER**

**051-048-12**  
12,5 cm, 5"

**051-048-14**  
14,0 cm, 5<sup>1</sup>/<sub>2</sub>"



**WEBSTER**  
13,0 cm, 5"  
051-029-13

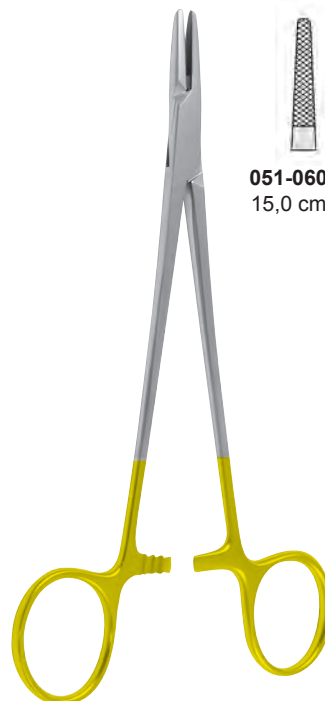
Nadelhalter mit Hartmetalleinlagen  
 Needle Holders with tungsten carbide inserts  
 Porta-agujas con bocas de carburo tungsteno  
 Portaghi con morsi in carburo di tungsteno



051-030-13

051-040-13

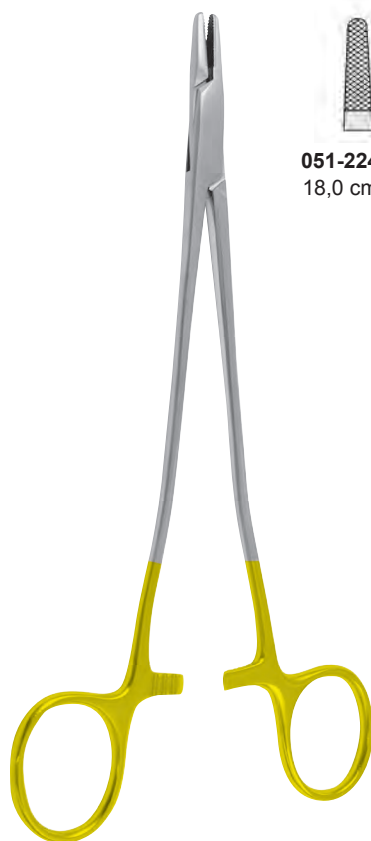
**HALSEY**  
 13,0 cm, 5"



051-060-15  
 15,0 cm, 6"

051-060-18  
 18,0 cm, 7"

**CRILE-WOOD**



051-224-18  
 18,0 cm, 7"

051-224-20  
 20,0 cm, 8"

051-224-26  
 26,0 cm, 10<sup>1</sup>/<sub>4</sub>"

**SAROT**



**IZIAL DENTAL SURGICAL**  
Manufacturer And Exporter Of Surgical Dental & Manicure

**Nadelhalter mit Hartmetalleinlagen**  
**Needle Holders with tungsten carbide inserts**  
**Porta-agujas con bocas de carburo tungsteno**  
**Portaghi con morsi in carburo di tungsteno**



**MAYO-HEGAR**



**051-080-16**  
16,0 cm, 6<sup>1</sup>/<sub>4</sub>"



**051-080-18**  
18,0 cm, 7"



**051-080-20**  
20,0 cm, 8"



**051-080-24**  
24,0 cm, 9<sup>1</sup>/<sub>2</sub>"



**051-080-26**  
26,0 cm, 10<sup>1</sup>/<sub>4</sub>"



**051-080-30**  
30,0 cm, 12"



**MAYO-HEGAR (HEANEY)**



**051-141-20**  
20,0 cm, 8"



**051-141-24**  
24,0 cm, 9<sup>1</sup>/<sub>4</sub>"

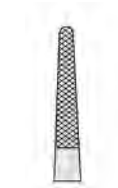


**051-141-26**  
26,0 cm, 10<sup>1</sup>/<sub>4</sub>"

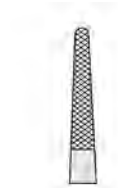
Nadelhalter mit Hartmetalleinlagen  
 Needle Holders with tungsten carbide inserts  
 Porta-agujas con bocas de carburo tungsteno  
 Portaghi con morsi in carburo di tungsteno



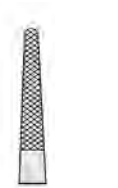
**DE BAKEY**



**051-114-18**  
 18,0 cm, 7"



**051-114-20**  
 20,0 cm, 8"



**051-114-23**  
 23,0 cm, 9"



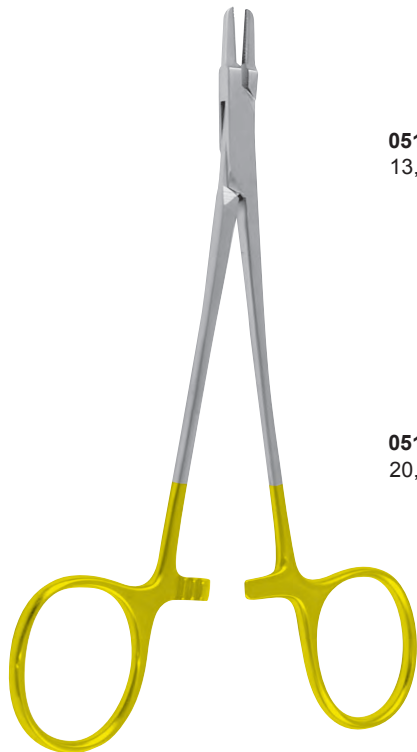
**051-114-26**  
 26,0 cm, 10<sup>1</sup>/<sub>4</sub>"



**051-114-31**  
 31,0 cm, 12<sup>1</sup>/<sub>4</sub>"



**051-114-37**  
 37,0 cm, 14<sup>1</sup>/<sub>2</sub>"



**RYDER-VASCULAR**



**051-132-13**  
 13,0 cm, 5"



**051-132-15**  
 15,0 cm, 6"



**051-132-18**  
 18,0 cm, 7"



**051-132-20**  
 20,0 cm, 8"



**051-132-23**  
 23,0 cm, 9"



**051-132-26**  
 26,0 cm, 10<sup>1</sup>/<sub>4</sub>"



**RYDER**



**051-134-13**  
13,0 cm, 5"



**051-134-15**  
15,0 cm, 6"



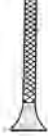
**051-134-18**  
18,0 cm, 7"



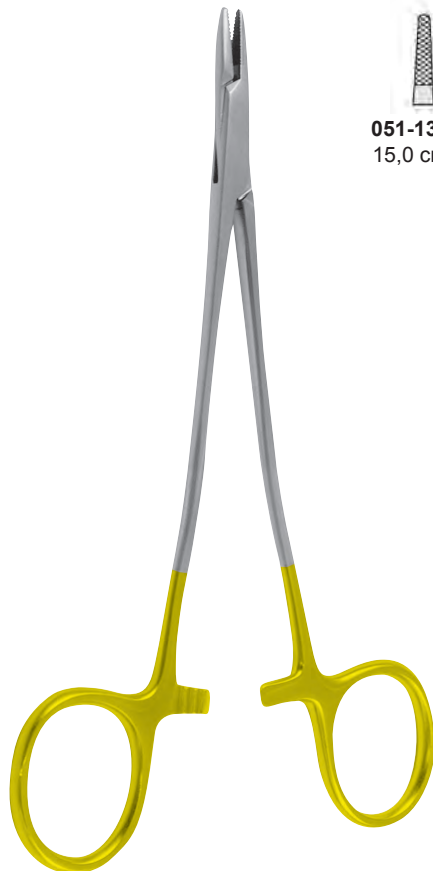
**051-134-20**  
20,0 cm, 8"



**051-134-23**  
23,0 cm, 9"



**051-134-26**  
26,0 cm, 10<sup>1</sup>/<sub>4</sub>"



**SCHWEDISCHES MODELL**



**051-136-15**  
15,0 cm, 6"

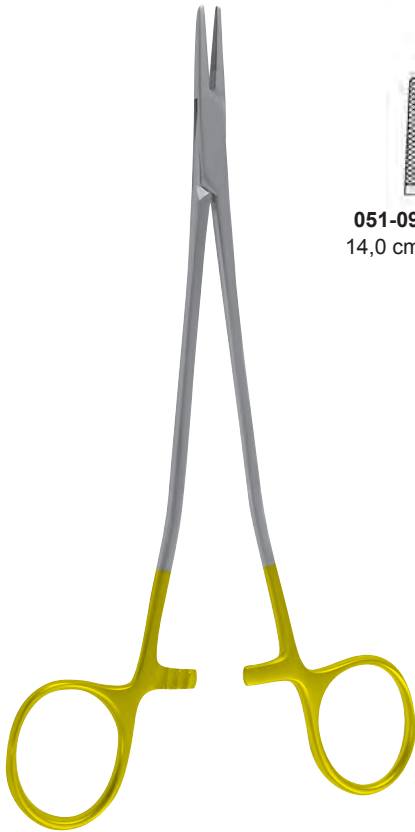


**051-136-17**  
17,0 cm, 6<sup>3</sup>/<sub>4</sub>"

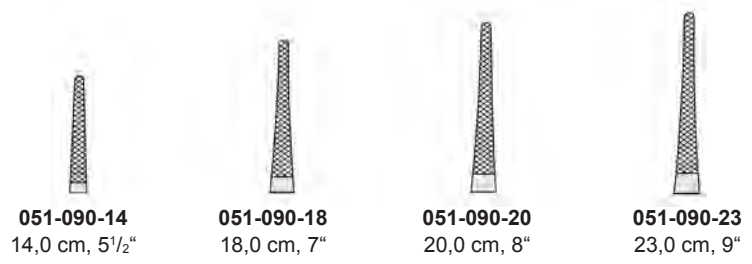


**051-136-20**  
20,0 cm, 8"

Nadelhalter mit Hartmetalleinlagen  
 Needle Holders with tungsten carbide inserts  
 Porta-agujas con bocas de carburo tungsteno  
 Portaghi con morsi in carburo di tungsteno



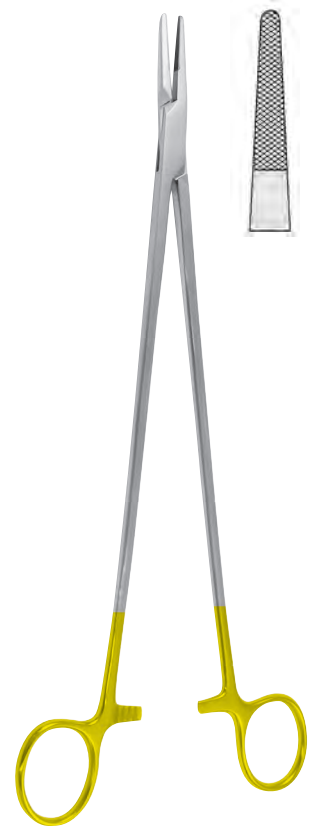
**MAYO-HEGAR (HEANEY)**



**FINOCCHIETTO**  
 27,0 cm, 10½"  
**051-211-27**



**MASSON**  
 27,0 cm, 10½"  
**051-150-27**

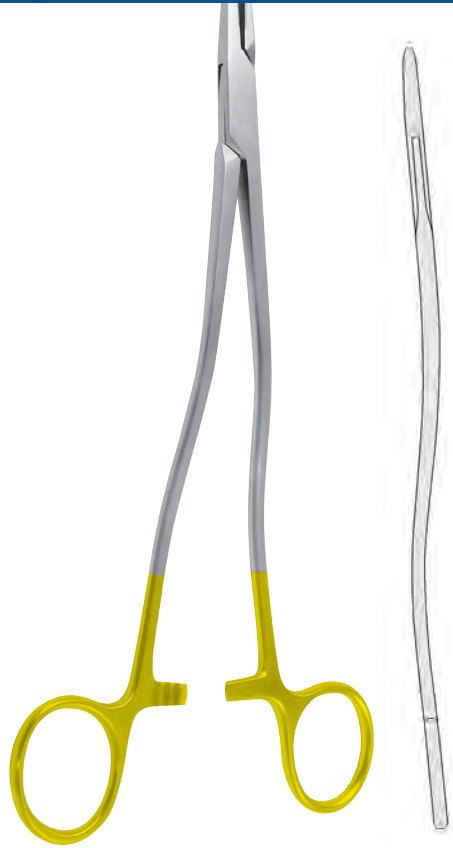


**WANGENSTEEN**  
 27,0 cm, 10½"  
**051-160-27**





**Nadelhalter mit Hartmetalleinlagen**  
**Needle Holders with tungsten carbide inserts**  
**Porta-agujas con bocas de carburo tungsteno**  
**Portaghi con morsi in carburo di tungsteno**



**BOZEMANN**



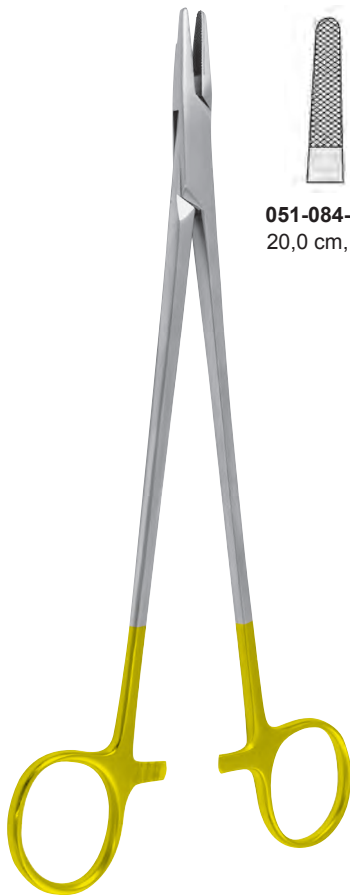
**051-185-20**  
20,0 cm, 8"



**051-185-24**  
24,0 cm, 9<sup>5</sup>/<sub>8</sub>"



**051-185-26**  
26,0 cm, 10<sup>1</sup>/<sub>4</sub>"



**HEGAR**



**051-084-20**  
20,0 cm, 8"



**051-084-24**  
24,0 cm, 9<sup>5</sup>/<sub>8</sub>"



**BARRY STERNAL**



**051-240-15**  
15,0 cm, 6"



**051-242-20**  
20,0 cm, 8"

Nadelhalter mit Hartmetalleinlagen  
 Needle Holders with tungsten carbide inserts  
 Porta-agujas con bocas de carburo tungsteno  
 Portaghi con morsi in carburo di tungsteno



**STRATTE**



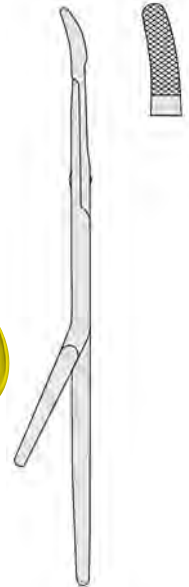
**051-230-22**  
 22,0 cm, 8<sup>5</sup>/<sub>8</sub>"



**051-230-23**  
 23,0 cm, 9"



**GILLIES**  
 16,0 cm, 6<sup>1</sup>/<sub>4</sub>"  
**051-330-16**



**OLSEN-HEGAR**



**051-310-14**  
 14,0 cm, 5<sup>1</sup>/<sub>2</sub>"



**051-310-17**  
 17,0 cm, 6<sup>3</sup>/<sub>4</sub>"



**051-310-18**  
 18,0 cm, 7"



**TOENNIS**  
 18,0 cm, 7"  
**051-362-18**



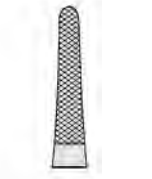
**MATHIEU-KOCHER**



**051-358-14**  
14,0 cm, 5½"



**051-358-17**  
17,0 cm, 6¾"



**051-358-20**  
20,0 cm, 8"



**MATHIEU**



**051-350-14**  
14,0 cm, 5½"



**051-350-17**  
17,0 cm, 6¾"



**051-350-20**  
20,0 cm, 8"

Nadelhalter mit Hartmetalleinlagen  
Needle Holders with tungsten carbide inserts  
Porta-agujas con bocas de carburo tungsteno  
Portaghi con morsi in carburo di tungsteno



**051-366-17**  
17,0 cm, 6<sup>3</sup>/<sub>4</sub>"

**051-366-20**  
20,0 cm, 8"

**LICHTENBERG**



**051-356-17**  
17,0 cm, 6<sup>3</sup>/<sub>4</sub>"

**051-356-20**  
20,0 cm, 8"

**051-356-23**  
23,0 cm, 9"

**MATHIEU**



**IZIAL DENTAL SURGICAL**  
Manufacturer And Exporter Of Surgical Dental & Manicure

**Nadelhalter mit Hartmetalleinlagen**  
**Needle Holders with tungsten carbide inserts**  
**Porta-agujas con bocas de carburo tungsteno**  
**Portaghi con morsi in carburo di tungsteno**



**ZWEIFEL**



**051-364-20**  
20,0 cm, 8"



**051-364-23**  
23,0 cm, 9"



**LANGENBECK**



**051-360-18**  
18,0 cm, 7"

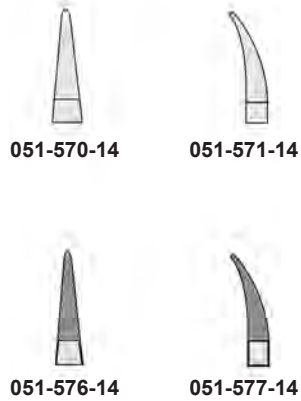


**051-360-20**  
20,0 cm, 8"



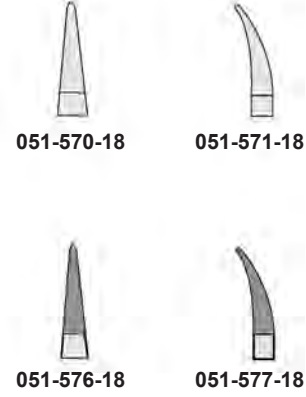
**051-360-23**  
23,0 cm, 9"

Nadelhalter mit Hartmetalleinlagen  
 Needle Holders with tungsten carbide inserts  
 Porta-agujas con bocas de carburo tungsteno  
 Portaghi con morsi in carburo di tungsteno



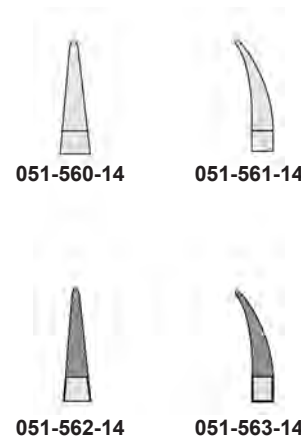
mit Sperre  
 with ratchet  
 con cremallera  
 con cremagliera

**CASTROVIEJO**  
 14,5 cm, 5<sup>3</sup>/<sub>4</sub>"



mit Sperre  
 with ratchet  
 con cremallera  
 con cremagliera

**CASTROVIEJO**  
 18,0 cm, 7"



mit Sperre  
 with ratchet  
 con cremallera  
 con cremagliera

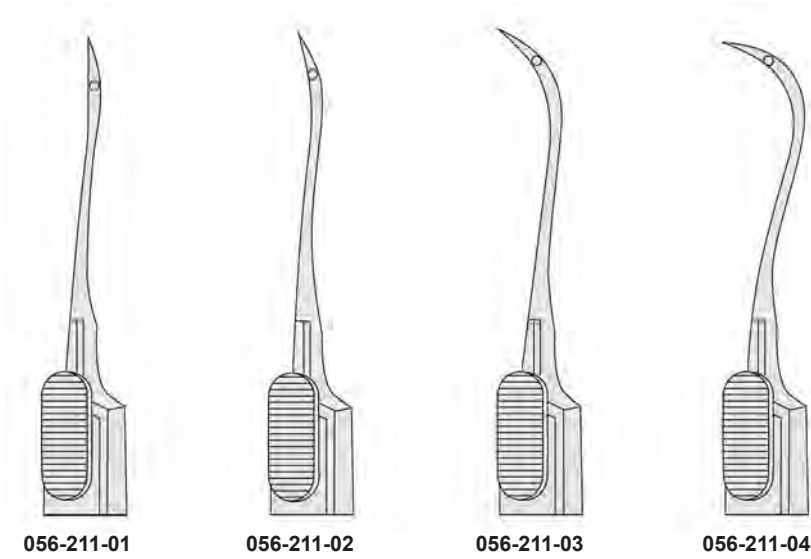
**BARRAQUER**  
 14,5 cm, 5<sup>3</sup>/<sub>4</sub>"



**HEPP SCHEIDEL**  
 18,0 cm, 7"  
 051-390-18



**REVERDIN**  
14,0 cm, 5 1/2"



**056-211-01**

**056-211-02**

**056-211-03**

**056-211-04**

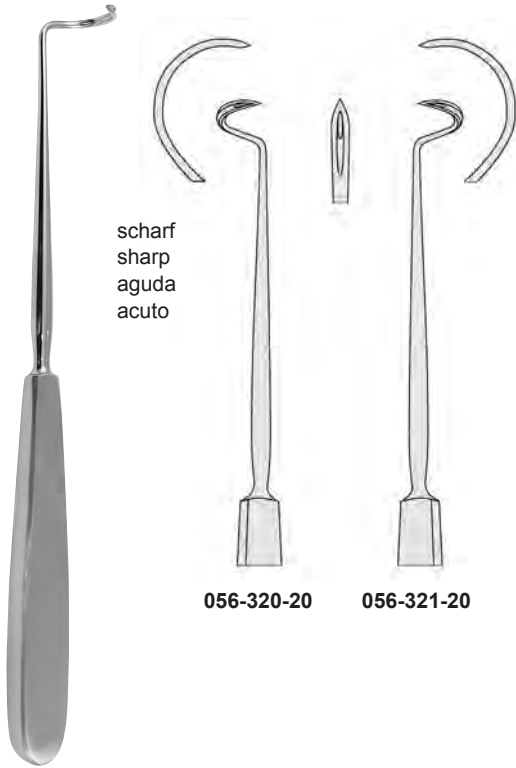


**REVERDIN**



19,5 cm, 7 3/4" **056-221-01** **056-221-02** **056-221-03** **056-221-04**  
22,5 cm, 8 3/4" **056-223-01** **056-223-02** **056-223-03** **056-223-04**

**Unterbindungsnadeln**  
**Ligature Needles**  
**Agujas para ligaduras**  
**Aghi per legatura**

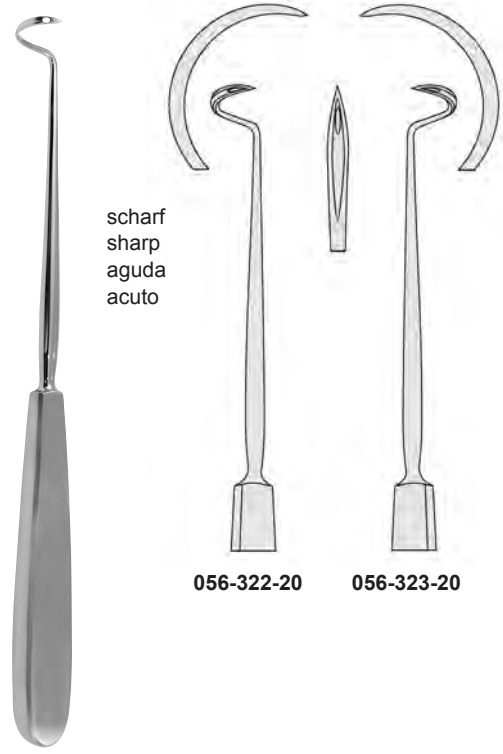


scharf  
 sharp  
 aguda  
 acuto

056-320-20

056-321-20

**DESCHAMPS**  
 20,0 cm, 8"

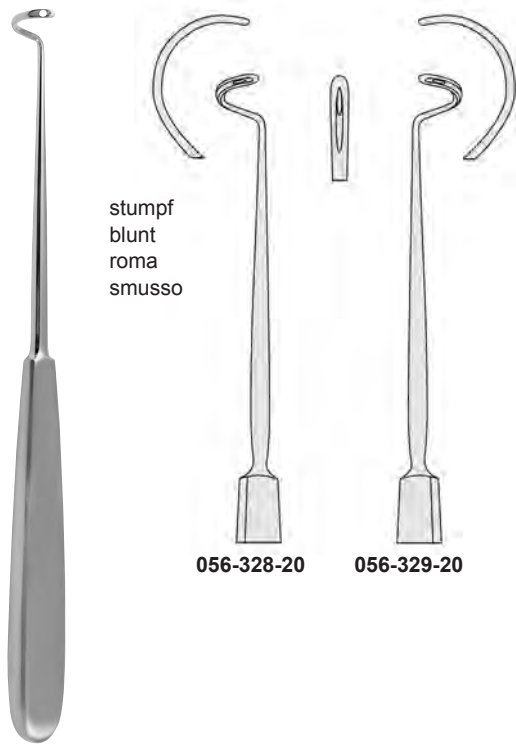


scharf  
 sharp  
 aguda  
 acuto

056-322-20

056-323-20

**DESCHAMPS**  
 20,0 cm, 8"

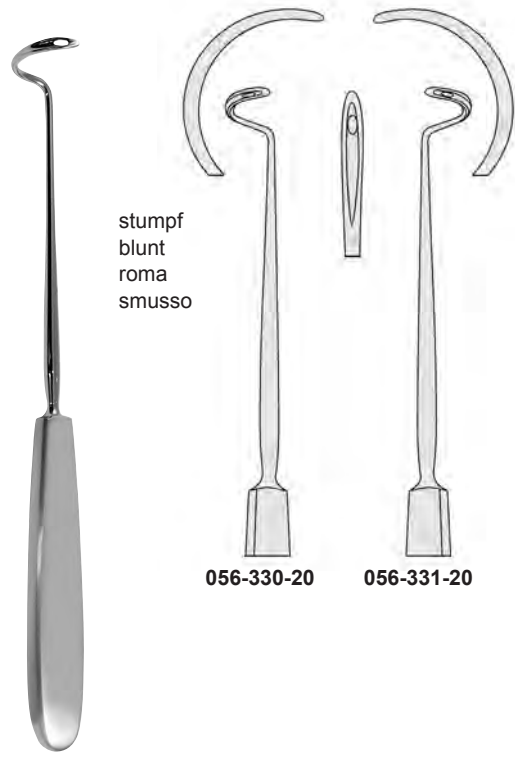


stumpf  
 blunt  
 roma  
 smusso

056-328-20

056-329-20

**DESCHAMPS**  
 20,0 cm, 8"



stumpf  
 blunt  
 roma  
 smusso

056-330-20

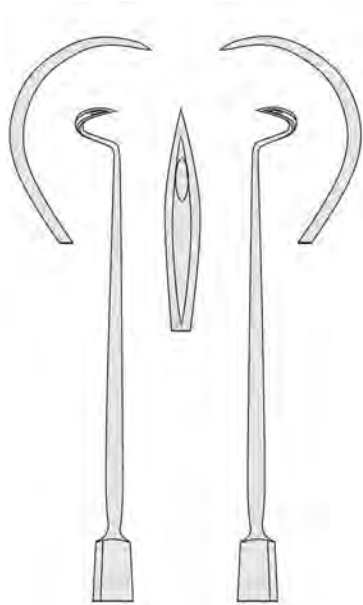
056-331-20

**DESCHAMPS**  
 20,0 cm, 8"





scharf  
sharp  
aguda  
acuto

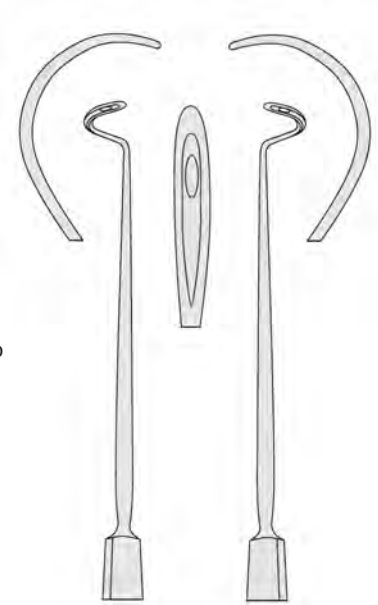


21,0 cm, 8<sup>1</sup>/<sub>4</sub>" **056-324-21** **056-325-21**  
27,0 cm, 10<sup>5</sup>/<sub>8</sub>" **056-324-27** **056-325-27**

**DESCHAMPS**



stumpf  
blunt  
roma  
smusso



21,0 cm, 8<sup>1</sup>/<sub>4</sub>" **056-332-21** **056-333-21**  
27,0 cm, 10<sup>5</sup>/<sub>8</sub>" **056-332-27** **056-333-27**

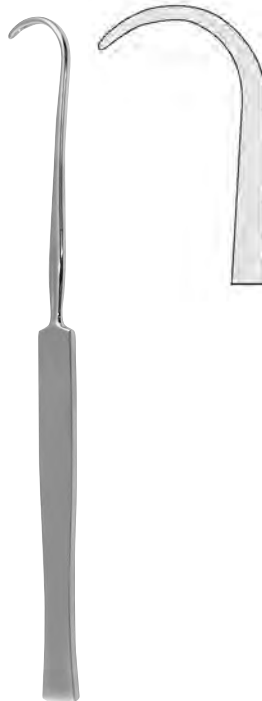
**DESCHAMPS**



20,0 cm, 8"  
**056-450-20**



biegsam  
malleable  
maleable  
malleabile



**COOPER**  
19,0 cm, 7<sup>1</sup>/<sub>2</sub>"  
**056-451-19**



**COOPER**  
20,0 cm, 8"  
**056-451-20**



**SYME**  
15,0 cm, 6"  
**056-453-15**



Unterbindungsnadeln  
Ligature Needles  
Agujas para ligaduras  
Aghi per legatura



056-452-01

**KOCHER**  
19,0 cm, 7<sup>1</sup>/<sub>2</sub>"



056-452-02



056-452-03



**BRUNNER**  
25,0 cm, 9<sup>3</sup>/<sub>4</sub>"  
056-455-25

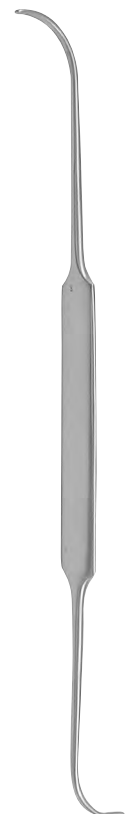


056-454-01

**BRUNNER**  
30,0 cm, 11<sup>3</sup>/<sub>4</sub>"



056-454-02



**SCHMIEDEN**  
21,0 cm, 8<sup>1</sup>/<sub>4</sub>"  
056-458-21



**YOUNG-HRYNTSCHAK**  
24,0 cm, 9 1/2"  
056-460-24



056-460-01



056-460-02



056-460-03



**DE LA ROZA**  
12,0 cm, 4 3/4"  
056-467-01



**DE LA ROZA**  
12,0 cm, 4 3/4"  
056-467-02



**JAKOBI**  
14,0 cm, 5 1/2"  
056-469-14



**HESSEBERG**  
15,0 cm, 6"  
056-468-15



**KRONECKER**  
15,0 cm, 6"  
056-470-01

Unterbindungsnadeln  
 Ligature Needles  
 Agujas para ligaduras  
 Aghi per legatura



**KRONECKER**  
 15,0 cm, 6"  
 056-470-02



**TRELAT**  
 23,0 cm, 9"  
 056-472-23



**CLAUS**  
 23,0 cm, 9"  
 056-473-23



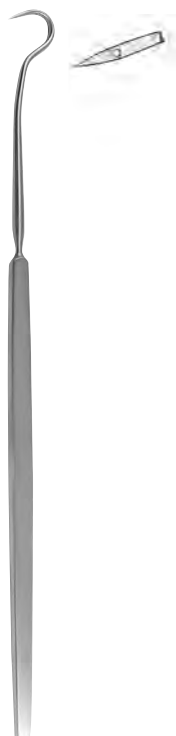
**HURD**  
 21,0 cm, 8 1/4"  
 056-474-01



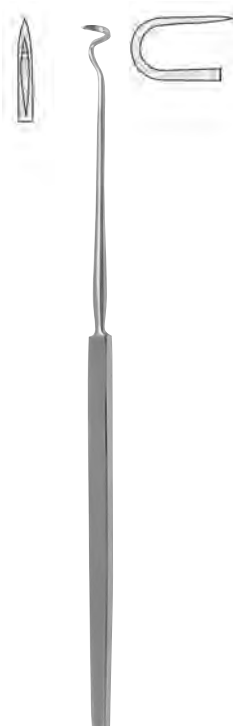
**HURD**  
 21,0 cm, 8 1/4"  
 056-474-02



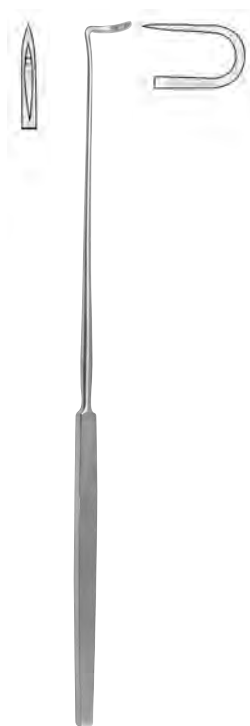
**NAGER**  
 24,0 cm, 9 1/2"  
 056-477-24



**CLAUS-EICKEN**  
 23,0 cm, 9"  
 056-481-23



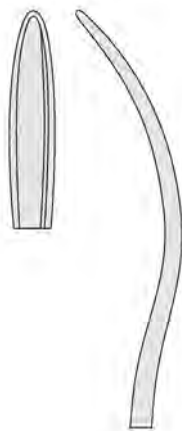
**FALK**  
 24,0 cm, 9 1/2"  
 056-480-01



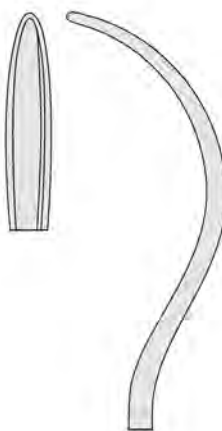
**FALK**  
 24,0 cm, 9 1/2"  
 056-480-02



**BRUNNER**  
30,0 cm, 11<sup>3</sup>/<sub>4</sub>"



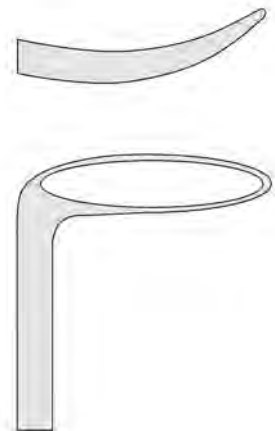
056-500-01



056-500-02



056-500-03



056-500-04



**PAYR**  
 22,0 cm, 8<sup>5</sup>/<sub>8</sub>"  
 056-502-22



**PAYR**  
 22,0 cm, 8<sup>5</sup>/<sub>8</sub>"  
 056-503-22



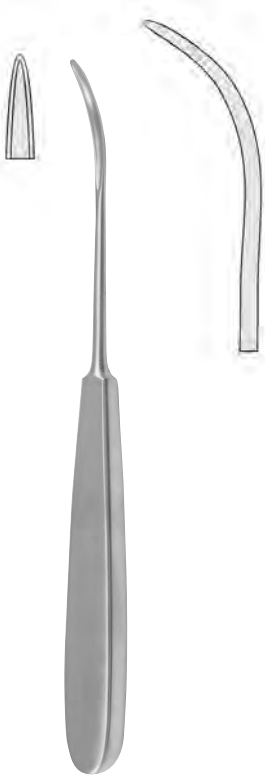
mit Loch  
 with hole  
 con foro  
 con ago

**SCHMIEDEN-PAYR**  
 19,0 cm, 7<sup>1</sup>/<sub>2</sub>"  
 056-506-19



ohne Loch  
 without hole  
 sin foro  
 senza ago

**SCHMIEDEN**  
 19,0 cm, 7<sup>1</sup>/<sub>2</sub>"  
 056-507-19



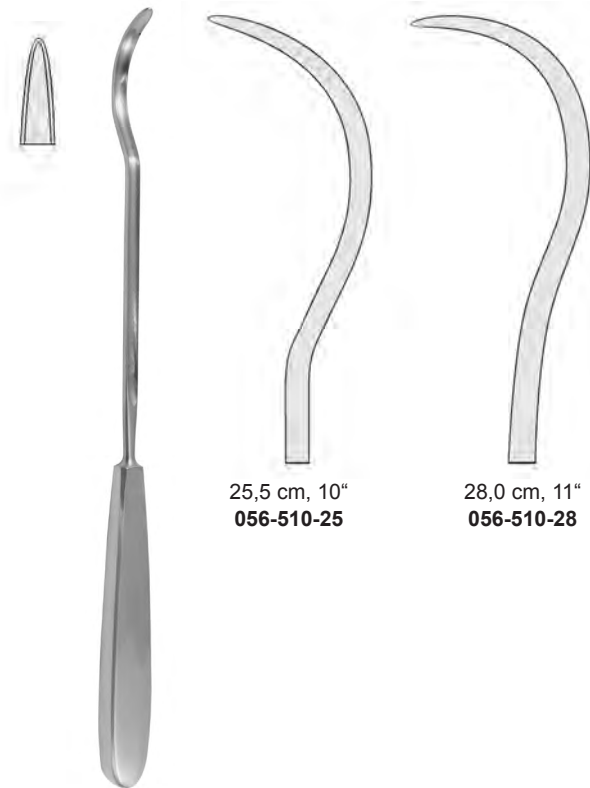
**KÖNIG**  
 19,5 cm, 7<sup>3</sup>/<sub>4</sub>"  
 056-508-03



**KÖNIG**  
 19,5 cm, 7<sup>3</sup>/<sub>4</sub>"  
 056-508-05



**KÖNIG**  
 19,5 cm, 7<sup>3</sup>/<sub>4</sub>"  
 056-508-07



25,5 cm, 10"  
**056-510-25**

28,0 cm, 11"  
**056-510-28**

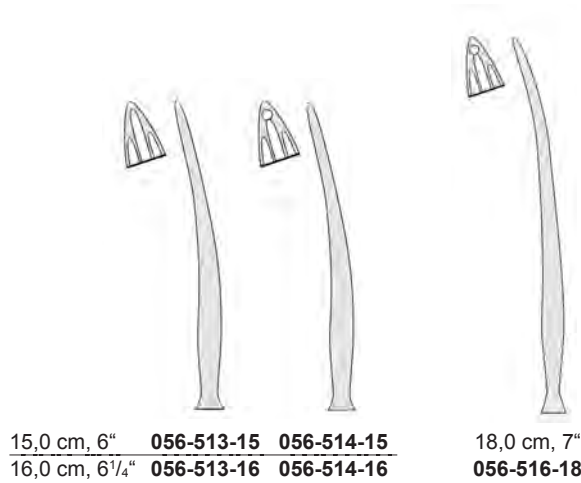
**KIRSCHNER**



**BRUNNER-FERROZELL**  
18,0 cm, 7" **056-521-18**  
27,0 cm, 10<sup>5</sup>/<sub>8</sub>" **056-521-27**



**KOCHER**



15,0 cm, 6" **056-513-15** **056-514-15**  
16,0 cm, 6<sup>1</sup>/<sub>4</sub>" **056-513-16** **056-514-16**

18,0 cm, 7"  
**056-516-18**



**MOD. WIEN**  
23,5 cm, 9<sup>1</sup>/<sub>4</sub>"  
056-532-23



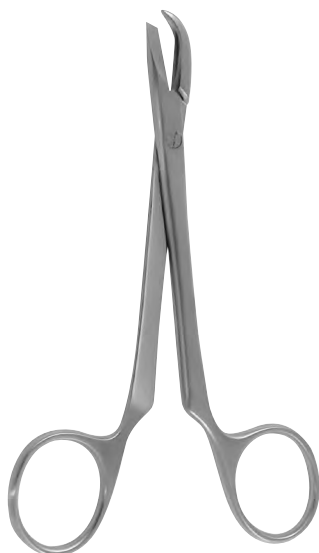
**BOZEMANN**  
21,0 cm, 8<sup>1</sup>/<sub>4</sub>"  
056-531-21



23,0 cm, 9"  
056-530-23



**MICHEL**  
12,0 cm, 4<sup>3</sup>/<sub>4</sub>"  
056-550-12



**COLLIN**  
13,0 cm, 5"  
056-552-13



**RICHTER-HEATH**  
14,0 cm, 5<sup>1</sup>/<sub>2</sub>"  
056-553-14



**WACHENFELDT**  
12,5 cm, 5"  
056-555-01



**HEGENBARTH**  
12,5 cm, 5"  
056-556-12





**MICHEL**  
12,0 cm, 4<sup>3</sup>/<sub>4</sub>"  
056-558-12



**LANGE**  
10,0 cm, 4"  
056-559-10



**CHILDE**  
18,0 cm, 7"  
056-560-01



**CHILDE CLIP**  
18,0 cm, 7"  
056-560-02



- 056-570-08 7,5 x 1,75 mm
- 056-570-11 11,0 x 2,0 mm
- 056-570-12 12,0 x 3,0 mm
- 056-570-14 14,0 x 3,0 mm
- 056-570-16 16,0 x 3,0 mm
- 056-570-18 18,0 x 3,0 mm
- 056-570-20 20,0 x 3,0 mm
- 056-570-22 22,0 x 3,0 mm

**MICHEL**



**CLIP-SET**  
056-558-00

bestehend aus, consisting of,  
compuesto de, composto da

- 1 x 056-558-12
- 1 x 056-550-12
- 50 x 056-570-14
- 1 x 056-590-01 (Etui)

**Wundhaken**  
**Retractors**  
**Separadores**  
**Divaricatori**

Dura- und Hauthäkchen  
 Dura and Skin Retractors  
 Gancho para piel y dura-madre  
 Unico per pelle e dura-madre

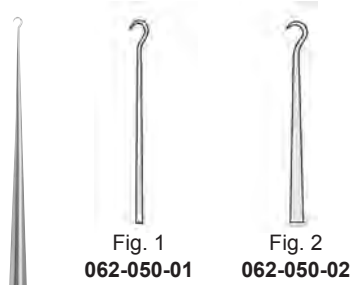


Fig. 1  
062-050-01

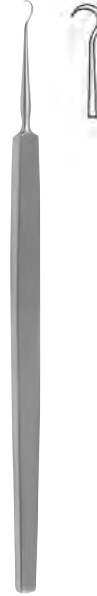
Fig. 2  
062-050-02



**GILLIES**  
18,0 cm, 7"



**KILNER**  
15,0 cm, 6"  
062-054-15



**FRAZIER**  
13,0 cm, 5"  
062-060-13



**O'CONNOR**  
16,0 cm, 6 1/4"  
062-074-16

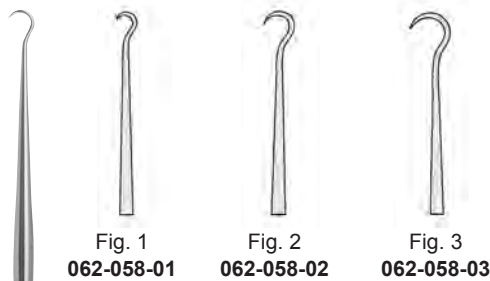


Fig. 1  
062-058-01

Fig. 2  
062-058-02

Fig. 3  
062-058-03



**KLEINERT-KUTZ**  
16,0 cm, 6 1/4"



**JOSEPH**  
16,0 cm, 6 1/4"  
062-062-16



**GRAEFE**  
16,0 cm, 6 1/4"



Fig. 1  
062-078-01



Fig. 2  
062-078-02

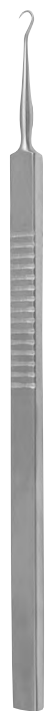


Fig. 1  
**062-070-01**



Fig. 2  
**062-070-02**



Fig. 3  
**062-070-03**



Fig. 4  
**062-070-04**

16,0 cm, 6 1/4"



Fig. 1  
**062-080-01**



Fig. 2  
**062-080-02**



**GUTHRIE**  
16,0 cm, 6 1/4"



**JOSEPH**  
16,0 cm, 6 1/4"

Fig. 1  
**062-086-01**



Fig. 2  
**062-086-02**



Fig. 3  
**062-086-03**



Fig. 4  
**062-086-04**



**Wundhaken  
Retractors  
Separadores  
Divaricatori**



**KNAPP**  
13,0 cm, 5"



Fig. 1  
**062-082-01**

scharf  
sharp  
agudos  
acuti



Fig. 2  
**062-082-02**

stumpf  
blunt  
romo  
smusso



16,0 cm, 6 1/4"



**062-088-02**



**062-088-03**



**062-088-04**



**062-089-02**



**062-089-03**



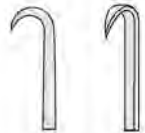
**062-089-04**



flexibel · flexible · flexibles · flessibili



16,0 cm, 6 1/4"



**062-101-01**



**062-101-02**



**062-101-03**



**062-101-04**

scharf  
sharp  
agudos  
acuti



**062-103-01**



**062-103-02**



**062-103-03**



**062-103-04**

halbscharf  
semi-sharp  
semi-agudos  
semi-acuti



**062-102-01**



**062-102-02**



**062-102-03**

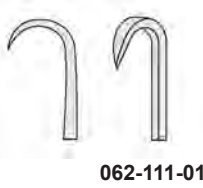


**062-102-04**

stumpf  
blunt  
romo  
smusso



16,0 cm, 6 1/4"



062-111-01



062-111-02

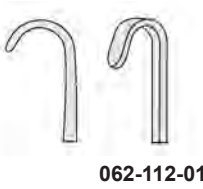


062-111-03



062-111-04

scharf  
sharp  
agudos  
acuti



062-112-01



062-112-02



062-112-03



062-112-04

stumpf  
blunt  
romo  
smusso



**CUSHING**  
19,0 cm, 7 1/2"



Fig. 1  
062-140-01



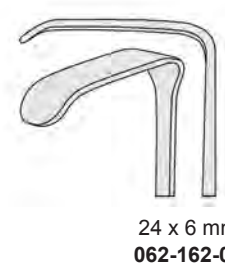
Fig. 2  
062-140-02



**LANGENBECK-GREEN**  
16,0 cm, 6 1/4"

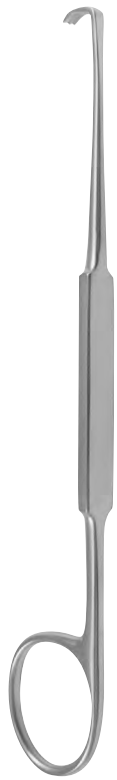


16 x 6 mm  
062-162-01



24 x 6 mm  
062-162-02

Wundhaken  
Retractors  
Separadores  
Divaricatori



**MEYERDING**  
18,0 cm, 7"



18 x 7 mm  
**062-150-01**



16 x 5 mm  
**062-150-02**



7 x 4 mm  
**062-150-03**



10 x 3 mm  
**062-150-04**



7 x 4 mm  
**062-150-05**



4 x 10 mm  
**062-150-06**



14 x 8 mm  
**062-166-16**



16,0 cm, 6 1/4"



**SENN-GREEN**  
15,0 cm, 6"



10 x 6 mm  
**062-160-10**



20 x 6 mm  
**062-160-20**



**MINI-LANGENBECK**  
16,0 cm, 6 1/4"



10 x 6 mm  
**062-164-01**



17 x 5 mm  
**062-164-02**



20 x 6 mm  
**062-164-03**



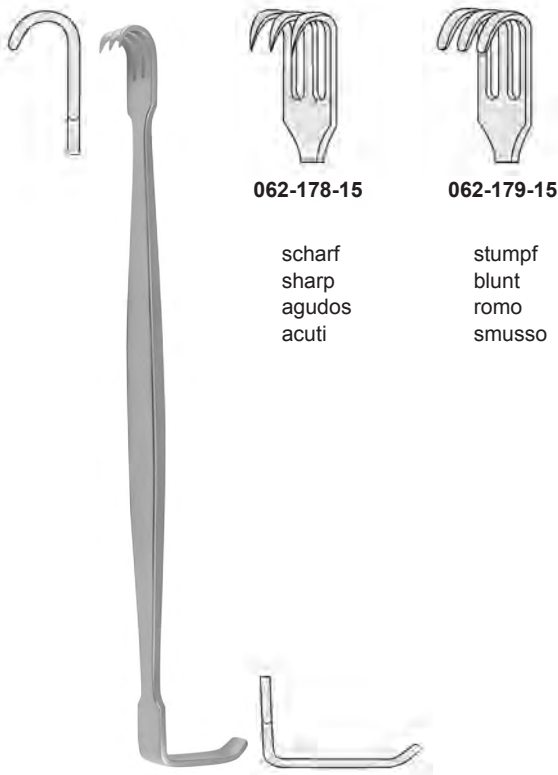
22 x 8 mm  
**062-164-04**



**RAGNELL-DAVIS**  
14,0 cm, 5 1/2"  
062-170-14



**RAGNELL**  
15,0 cm, 6"  
062-174-15



**BABY SENN-MILLER**  
15,0 cm, 6"

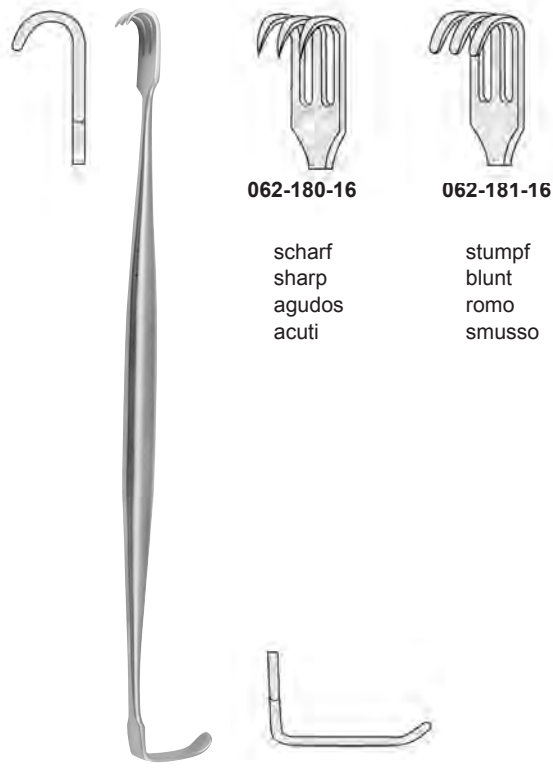
062-178-15

scharf  
sharp  
agudos  
acuti



062-179-15

stumpf  
blunt  
romo  
smusso



**SENN-MILLER**  
16,0 cm, 6 1/4"

062-180-16

scharf  
sharp  
agudos  
acuti



062-181-16

stumpf  
blunt  
romo  
smusso



Wundhaken  
Retractors  
Separadores  
Divaricatori



8 mm  
**062-200-08**



10 mm  
**062-200-10**



12 mm  
**062-200-12**



14 mm  
**062-200-14**



16 mm  
**062-200-16**



18 mm  
**062-200-18**

**DESMARRES**  
13,0 cm, 5"



8 mm  
**062-204-08**



10 mm  
**062-204-10**



12 mm  
**062-204-12**



14 mm  
**062-204-14**



16 mm  
**062-204-16**



18 mm  
**062-204-18**

**DESMARRES**  
16,0 cm, 6 1/4"



**CUSHING**  
20,0 cm, 8"



8 mm  
**062-210-08**



10 mm  
**062-210-10**



12 mm  
**062-210-12**



14 mm  
**062-210-14**



16 mm  
**062-210-16**



18 mm  
**062-210-18**



**CUSHING**  
24,0 cm, 9 1/2"



8 mm  
**062-212-08**



10 mm  
**062-212-10**



12 mm  
**062-212-12**



14 mm  
**062-212-14**



16 mm  
**062-212-16**

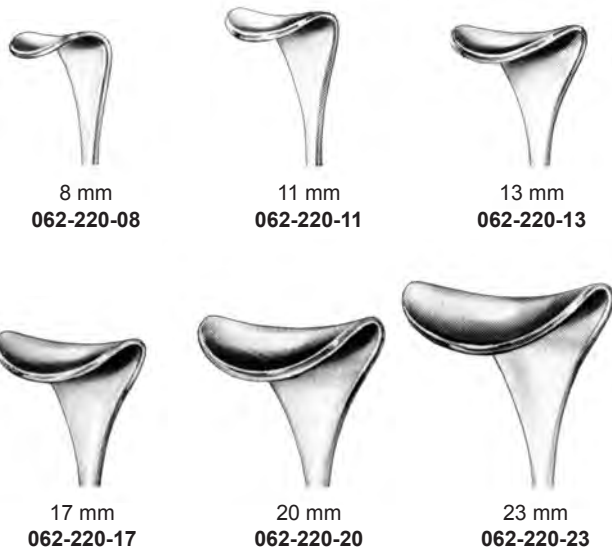


18 mm  
**062-212-18**

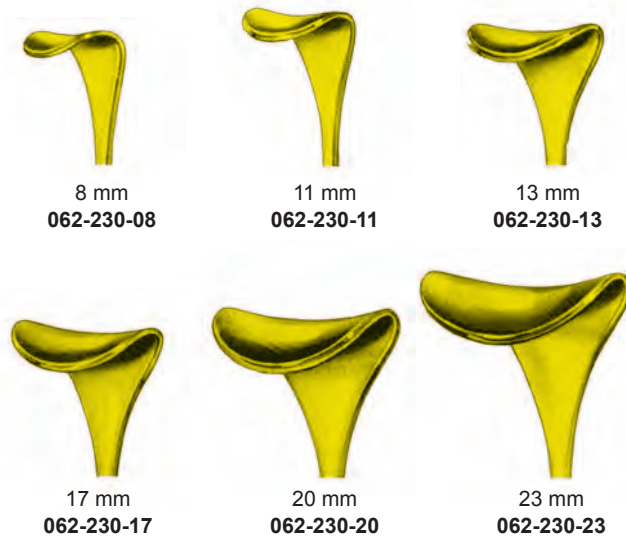
Wundhaken  
Retractors  
Separadores  
Divaricatori



**GIL-VERNET**  
24,0 cm, 9 1/2"



**GIL-VERNET**  
24,0 cm, 9 1/2"



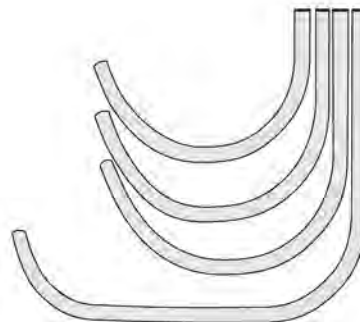
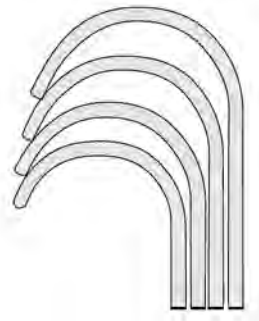


**ROUX**

- Fig. 1 24 x 20 mm
- Fig. 2 29 x 26 mm
- Fig. 3 33 x 29 mm
- Fig. 4 29 x 24 mm

Satz, Fig. 1-3  
Set, fig. 1-3  
Juego, fig. 1-3  
Serie, fig. 1-3

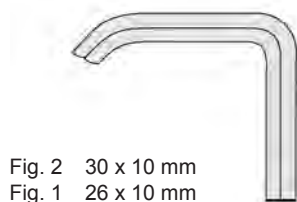
- Fig. 1 30 x 28 mm
- Fig. 2 36 x 36 mm
- Fig. 3 38 x 43 mm
- Fig. 4 45 x 28 mm



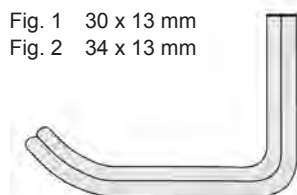
- |          |  |                   |
|----------|--|-------------------|
| Fig. 1-3 | 17,0 cm, 6 <sup>3</sup> / <sub>4</sub> " | <b>062-310-00</b> |
| Fig. 1   | 14,0 cm, 5 <sup>1</sup> / <sub>2</sub> " | <b>062-310-01</b> |
| Fig. 2   | 15,0 cm, 6"                              | <b>062-310-02</b> |
| Fig. 3   | 17,0 cm, 6 <sup>3</sup> / <sub>4</sub> " | <b>062-310-03</b> |
| Fig. 4   | 18,0 cm, 7"                              | <b>062-310-04</b> |



**FARABEUF**  
12,0 cm, 4<sup>3</sup>/<sub>4</sub>"  
**062-300-12**



- Fig. 2 30 x 10 mm
- Fig. 1 26 x 10 mm



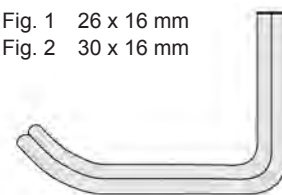
- Fig. 1 30 x 13 mm
- Fig. 2 34 x 13 mm



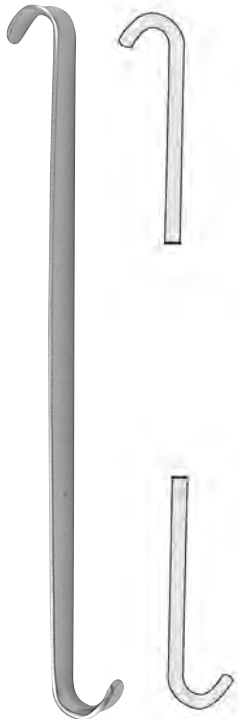
**FARABEUF**  
15,0 cm, 5<sup>3</sup>/<sub>4</sub>"  
**062-302-15**



- Fig. 2 23 x 16 mm
- Fig. 1 27 x 16 mm



- Fig. 1 26 x 16 mm
- Fig. 2 30 x 16 mm



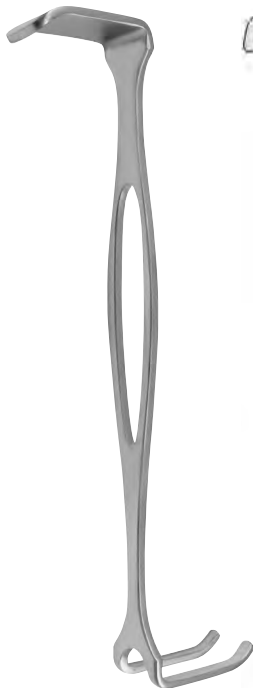
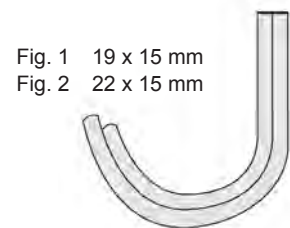
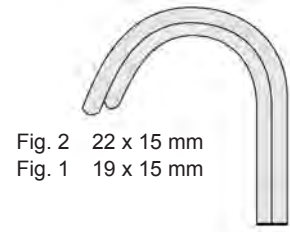
**MINI-ROUX**  
14,0 cm, 5<sup>1</sup>/<sub>2</sub>"  
062-340-06



**BABY-ROUX**  
13,0 cm, 5"  
062-342-13



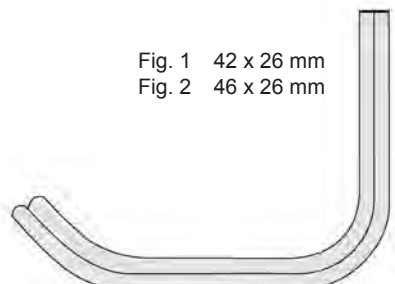
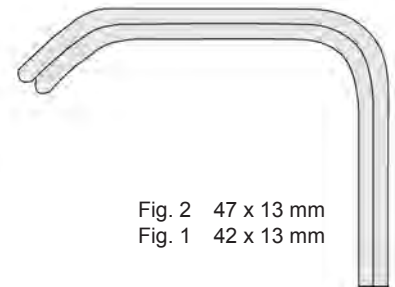
**PARKER**  
13,5 cm, 5<sup>3</sup>/<sub>8</sub>"  
062-350-00

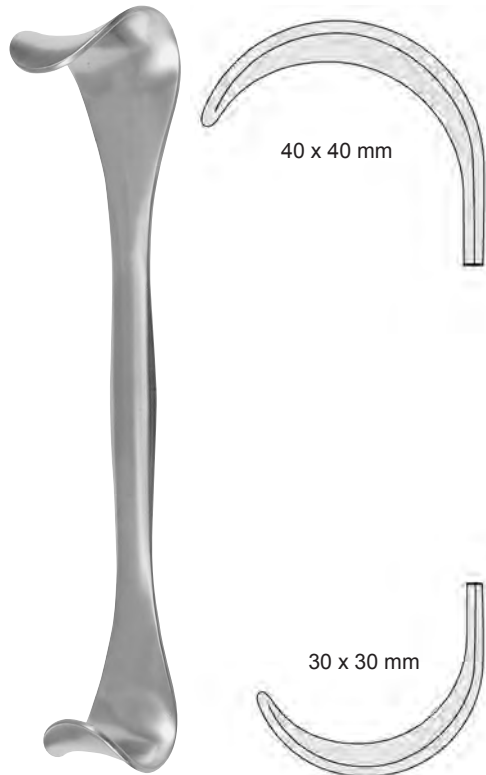


**CZERNY**  
17,5 cm, 7"  
062-360-00

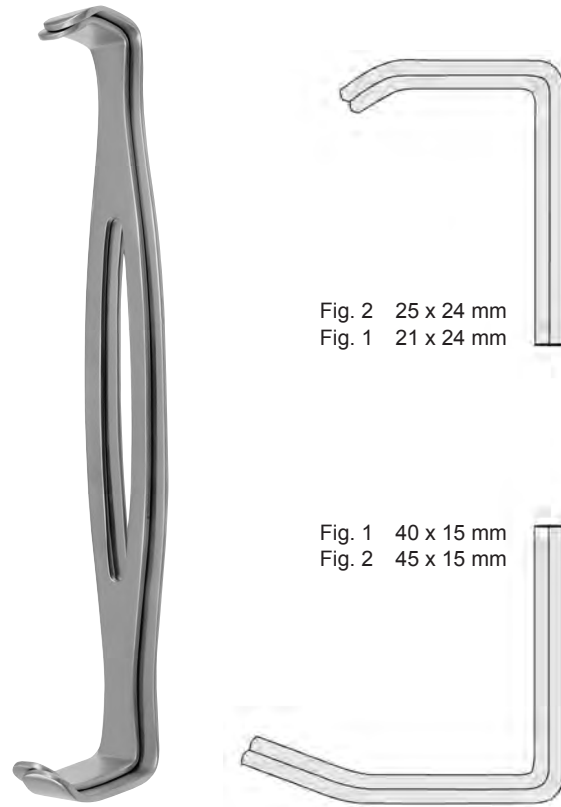


**MATHIEU**  
20,0 cm, 8"  
062-380-00

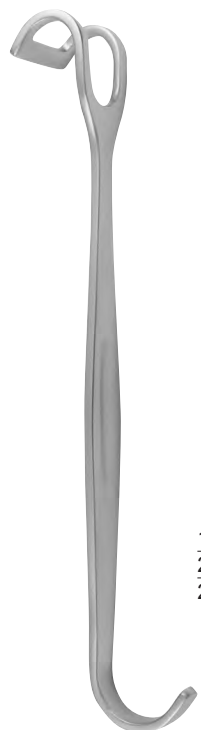




**GOELET**  
19,0 cm, 7 1/2"  
**062-396-19**



**PARKER-LANGENBECK**  
21,0 cm, 8 1/4"  
**062-390-00**



16 mm	19,0 cm, 7 1/2"	<b>062-370-16</b>
20 mm	19,0 cm, 7 1/2"	<b>062-370-20</b>
25 mm	20,0 cm, 8"	<b>062-370-25</b>

**CANNY RYAL**

Wundhaken  
 Retractors  
 Separadores  
 Divaricatori



**VOLKMANN**  
 21,5 cm, 8½"



**064-001-01**



9 x 8 mm  
**064-001-02**



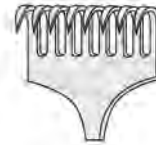
9 x 13 mm  
**064-001-03**



9 x 19 mm  
**064-001-04**



9 x 29 mm  
**064-001-06**



9 x 40 mm  
**064-001-08**

scharf  
 sharp  
 agudos  
 acuti



**VOLKMANN**  
 21,5 cm, 8½"



**064-003-01**



9 x 8 mm  
**064-003-02**



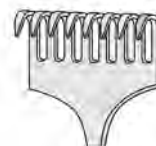
9 x 13 mm  
**064-003-03**



9 x 19 mm  
**064-003-04**



9 x 29 mm  
**064-003-06**



9 x 40 mm  
**064-003-08**

halbscharf  
 semi-sharp  
 semi-agudos  
 semi-acuti



**VOLKMANN**  
21,5 cm, 8 1/2"



**064-002-01**



9 x 8 mm  
**064-002-02**



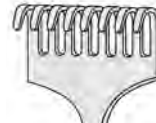
9 x 13 mm  
**064-002-03**



9 x 19 mm  
**064-002-04**



9 x 29 mm  
**064-002-06**



9 x 40 mm  
**064-002-08**

stumpf  
blunt  
romo  
smusso



**KOCHER**  
22,0 cm, 8 5/8"



**064-011-01**



9 x 8 mm  
**064-011-02**



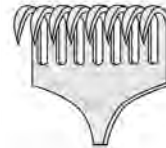
15 x 15 mm  
**064-011-03**



15 x 20 mm  
**064-011-04**



15 x 30 mm  
**064-011-06**



15 x 40 mm  
**064-011-08**

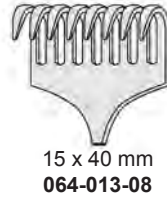
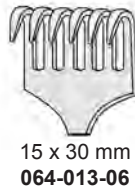
scharf  
sharp  
agudos  
acuti



Wundhaken  
 Retractors  
 Separadores  
 Divaricatori



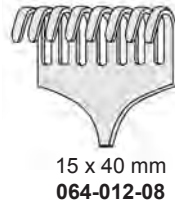
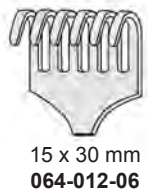
**KOCHER**  
 22,0 cm, 8<sup>5</sup>/<sub>8</sub>"



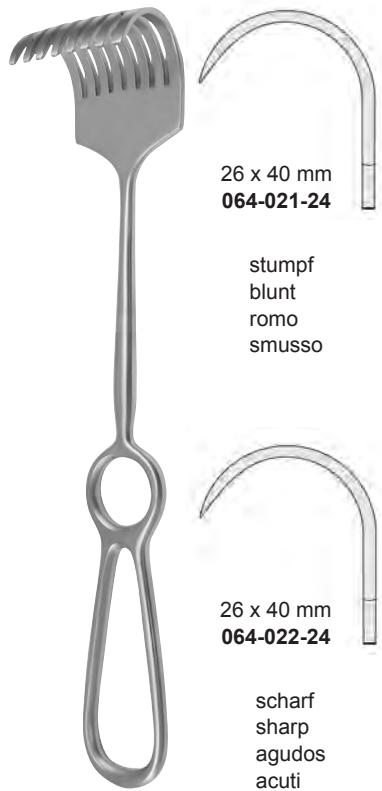
halbscharf  
 semi-sharp  
 semi-agudos  
 semi-acuti



**KOCHER**  
 22,0 cm, 8<sup>5</sup>/<sub>8</sub>"



stumpf  
 blunt  
 romo  
 smusso



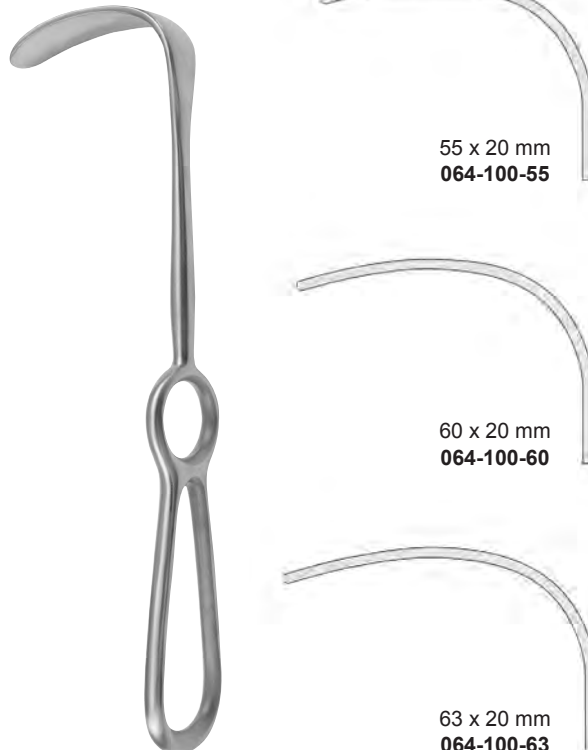
26 x 40 mm  
**064-021-24**

stumpf  
blunt  
romo  
smusso

26 x 40 mm  
**064-022-24**

scharf  
sharp  
agudos  
acuti

**KOERTE**  
24,0 cm, 9<sup>1</sup>/<sub>2</sub>"



55 x 20 mm  
**064-100-55**

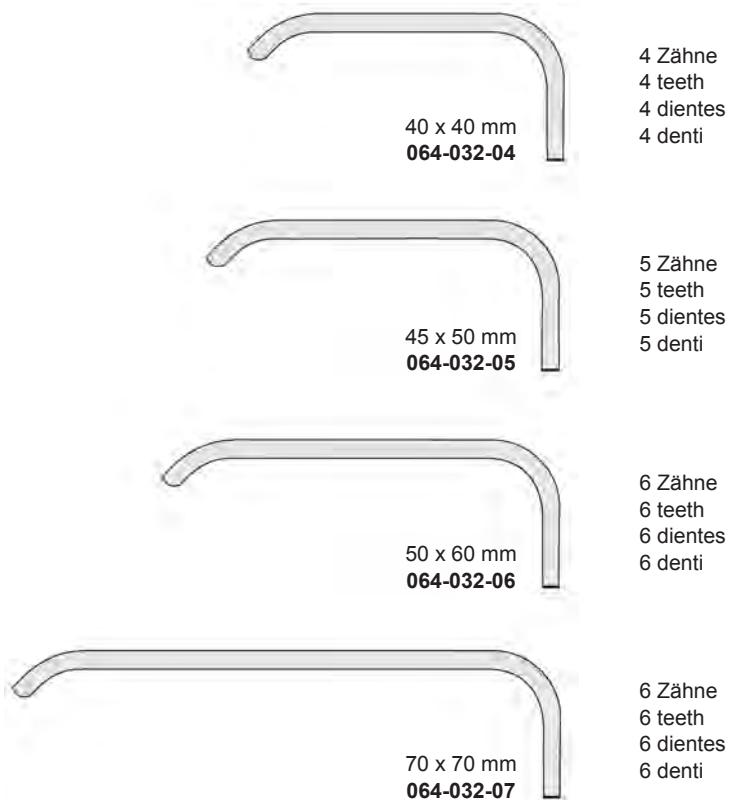
60 x 20 mm  
**064-100-60**

63 x 20 mm  
**064-100-63**

**LANGENBECK**  
21,0 cm, 8<sup>1</sup>/<sub>4</sub>"



**ISRAEL**  
25,0 cm, 9<sup>3</sup>/<sub>4</sub>"



Wundhaken  
Retractors  
Separadores  
Divaricatori



**LANGENBECK**  
22,0 cm, 8<sup>5</sup>/<sub>8</sub>"



30 x 11 mm  
**064-110-30**



30 x 14 mm  
**064-110-31**



30 x 16 mm  
**064-110-32**



40 x 11 mm  
**064-110-40**



50 x 11 mm  
**064-110-50**



**LANGENBECK**  
22,0 cm, 8<sup>5</sup>/<sub>8</sub>"



30 x 11 mm  
**064-120-30**



30 x 14 mm  
**064-120-31**



30 x 16 mm  
**064-120-32**



40 x 11 mm  
**064-120-40**



50 x 11 mm  
**064-120-50**



**KOCHER-LANGENBECK**  
21,5 cm, 8<sup>1</sup>/<sub>2</sub>"



22 x 6 mm  
**064-130-22**



25 x 6 mm  
**064-130-25**



25 x 8 mm  
**064-130-26**



35 x 8 mm  
**064-130-35**



35 x 11 mm  
**064-130-36**



35 x 15 mm  
**064-130-37**



40 x 11 mm  
**064-130-40**



70 x 14 mm  
**064-130-70**



80 x 12 mm  
**064-130-80**

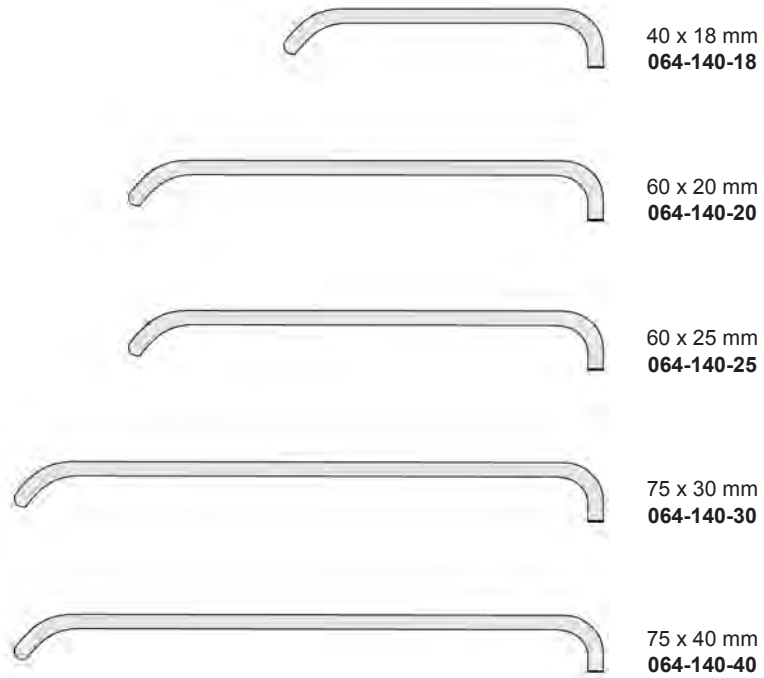


80 x 16 mm  
**064-130-85**

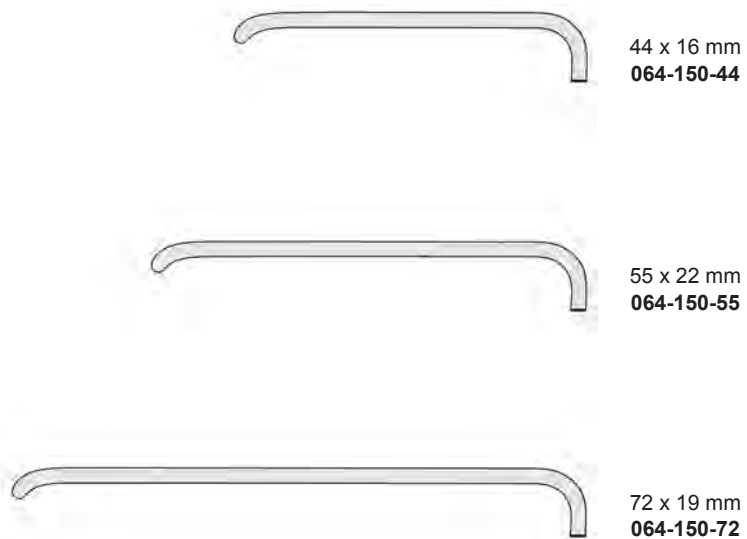
Wundhaken  
Retractors  
Separadores  
Divaricatori



**KOCHER**  
23,0 cm, 9"



**SAUERBRUCH**  
22,5 cm, 8<sup>3</sup>/<sub>4</sub>"





**MIDDELDORPF**



21,5 cm, 8<sup>1</sup>/<sub>2</sub>"  
14 x 17 mm  
**064-180-01**



22,0 cm, 8<sup>5</sup>/<sub>8</sub>"  
20 x 22 mm  
**064-180-02**



23,5 cm, 9<sup>1</sup>/<sub>4</sub>"  
26 x 30 mm  
**064-180-03**



**MIDDELDORPF**



21,5 cm, 8<sup>1</sup>/<sub>2</sub>"  
14 x 17 mm  
**064-182-01**



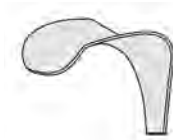
22,0 cm, 8<sup>5</sup>/<sub>8</sub>"  
20 x 22 mm  
**064-182-02**



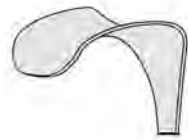
23,5 cm, 9<sup>1</sup>/<sub>4</sub>"  
26 x 30 mm  
**064-182-03**



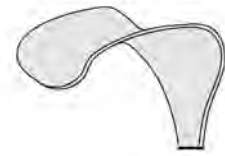
**RICHARDSON (KELLY)**  
24,0 cm, 9<sup>1</sup>/<sub>2</sub>"



28 x 20 mm  
**064-210-02**



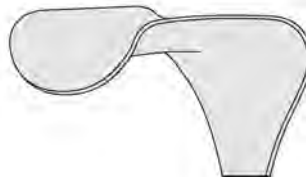
36 x 28 mm  
**064-210-03**



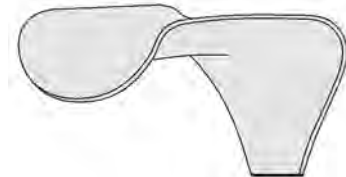
44 x 38 mm  
**064-210-04**



52 x 22 mm  
**064-210-05**



65 x 50 mm  
**064-210-06**



70 x 65 mm  
**064-210-07**

**Wundhaken  
Retractors  
Separadores  
Divaricatori**

49 x 38 mm

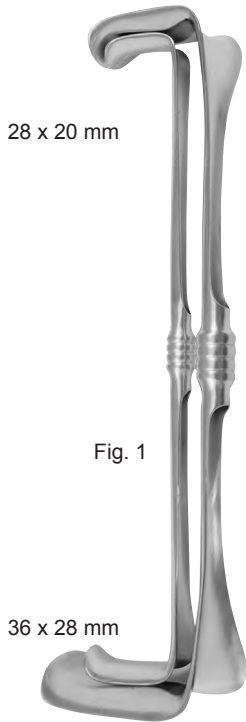


Fig. 2

Fig. 1

Fig. 1+2	28,0 cm, 11"	<b>062-200-00</b>
Fig. 1	26,0 cm, 10 <sup>1</sup> / <sub>4</sub> "	<b>062-200-01</b>
Fig. 2	28,0 cm, 11"	<b>062-200-02</b>

36 x 28 mm

63 x 49 mm

**RICHARDSON-EASTMAN**

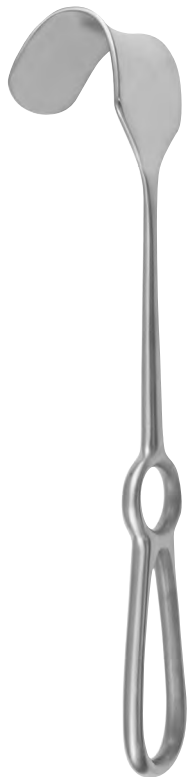


**MIDDELDORPF**

25,5 cm, 10"



40 x 45 mm	<b>064-192-01</b>
45 x 50 mm	<b>064-192-02</b>
55 x 70 mm	<b>064-192-03</b>



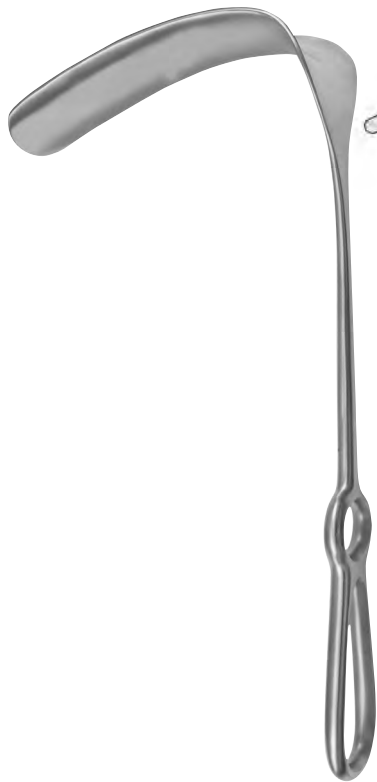
**FRITSCH**  
24,0 cm, 9<sup>1</sup>/<sub>2</sub>"



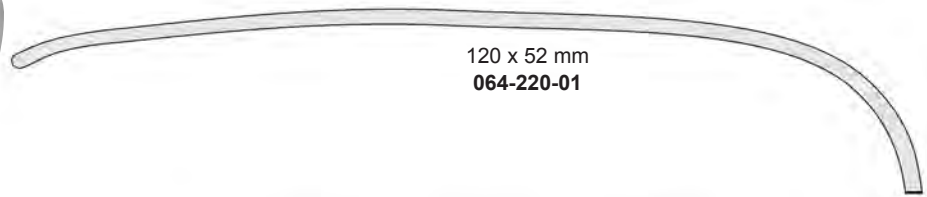
45 x 40 mm	<b>064-240-40</b>
45 x 50 mm	<b>064-240-50</b>
45 x 60 mm	<b>064-240-60</b>
55 x 75 mm	<b>064-240-75</b>
65 x 85 mm	<b>064-240-85</b>



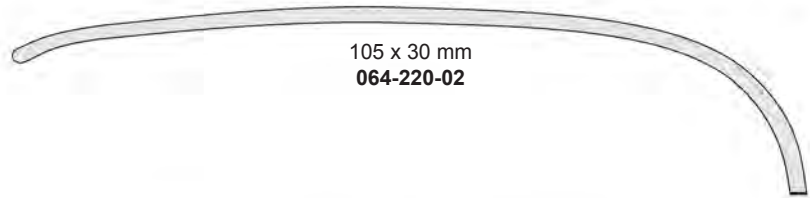
**DOYEN**  
25,0 cm, 10"  
**064-230-50**



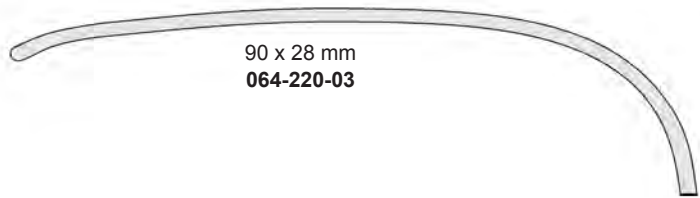
**DOYEN-STILLE**  
22,0 cm, 8<sup>5</sup>/<sub>16</sub>"



120 x 52 mm  
**064-220-01**



105 x 30 mm  
**064-220-02**

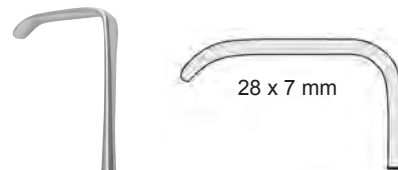


90 x 28 mm  
**064-220-03**



**KOCHER**  
25,0 cm, 10"

- |            |                   |
|------------|-------------------|
| 70 x 25 mm | <b>064-250-70</b> |
| 80 x 42 mm | <b>064-250-81</b> |
| 80 x 50 mm | <b>064-250-82</b> |
| 80 x 60 mm | <b>064-250-83</b> |



28 x 7 mm



**LAHEY**  
19,0 cm, 7<sup>1</sup>/<sub>2</sub>"  
**061-160-19**



Wundhaken  
 Retractors  
 Separadores  
 Divaricatori



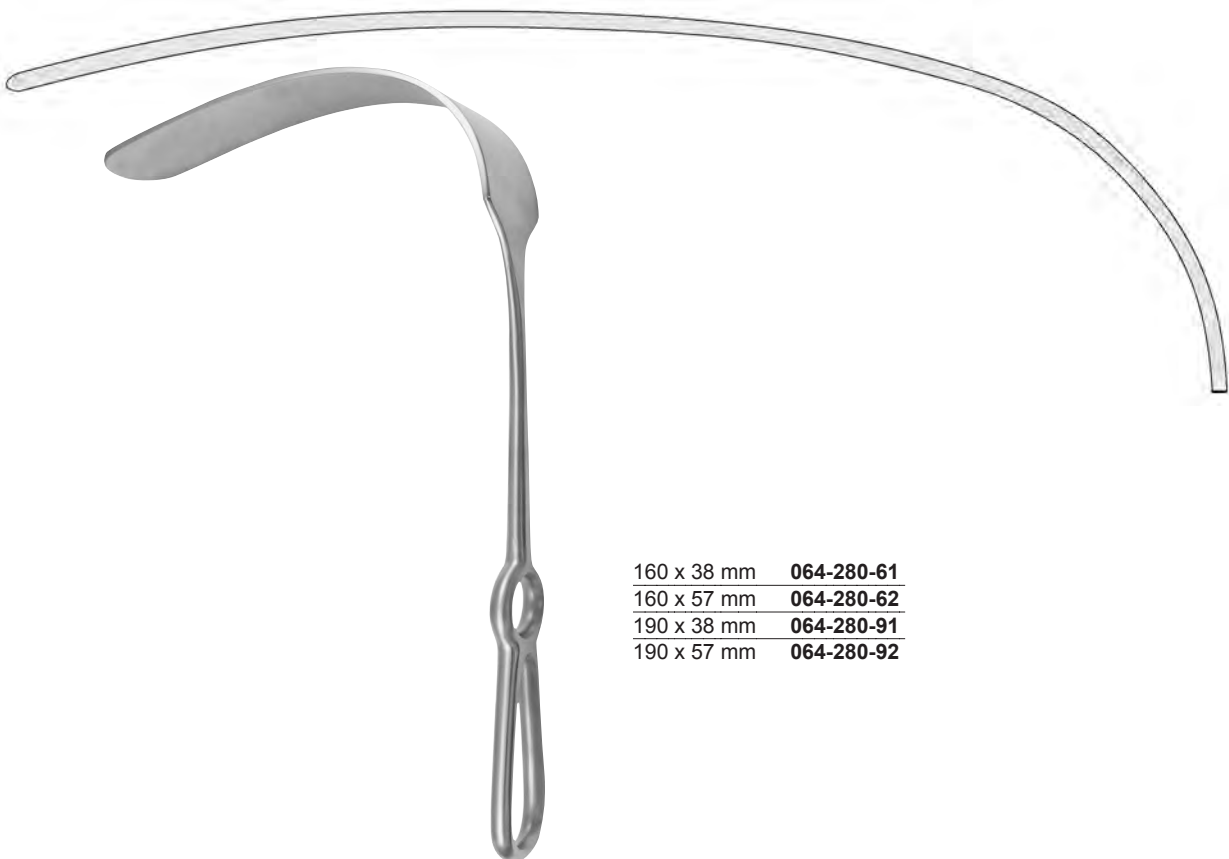
**LITTLE**  
 20,0 cm, 8"  
 064-164-20



12 x 13 mm



**SIMON**  
 28,0 cm, 11"  
 115 x 22 mm **064-260-01**  
 115 x 27 mm **064-260-02**



160 x 38 mm **064-280-61**  
 160 x 57 mm **064-280-62**  
 190 x 38 mm **064-280-91**  
 190 x 57 mm **064-280-92**

**KELLY**  
 27,0 cm, 10<sup>1</sup>/<sub>2</sub>"



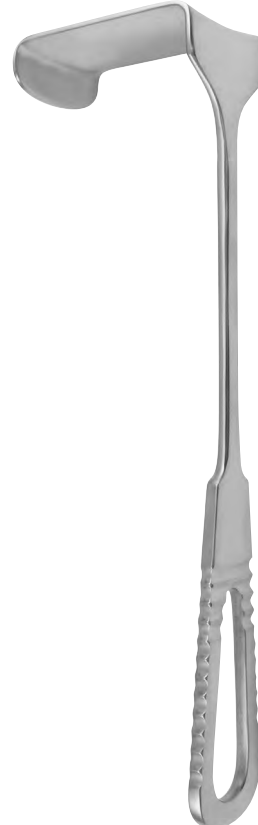
85 x 35 mm	<b>064-274-01</b>
120 x 50 mm	<b>064-274-02</b>
150 x 50 mm	<b>064-274-03</b>

**MIKULICZ**  
26,0 cm, 10<sup>1</sup>/<sub>4</sub>"



90 x 50 mm

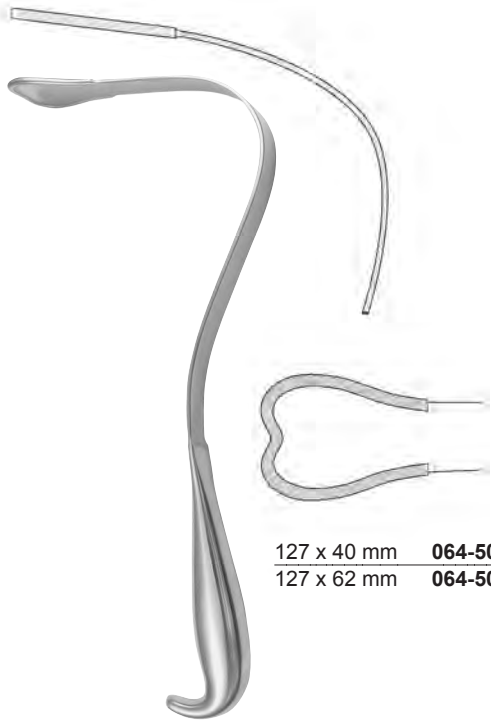
**MIKULICZ**  
26,0 cm, 10<sup>1</sup>/<sub>4</sub>"  
**064-272-90**



70 x 38 mm	<b>064-290-38</b>
70 x 50 mm	<b>064-290-51</b>

**MORRIS**  
24,5 cm, 9<sup>5</sup>/<sub>8</sub>"

Wundhaken  
 Retractors  
 Separadores  
 Divaricatori



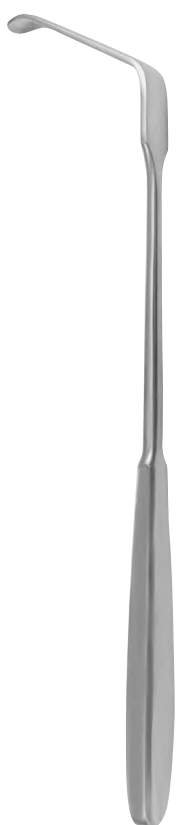
127 x 40 mm **064-500-40**  
 127 x 62 mm **064-500-62**

**HARRINGTON**  
 32,0 cm, 12<sup>1</sup>/<sub>2</sub>"

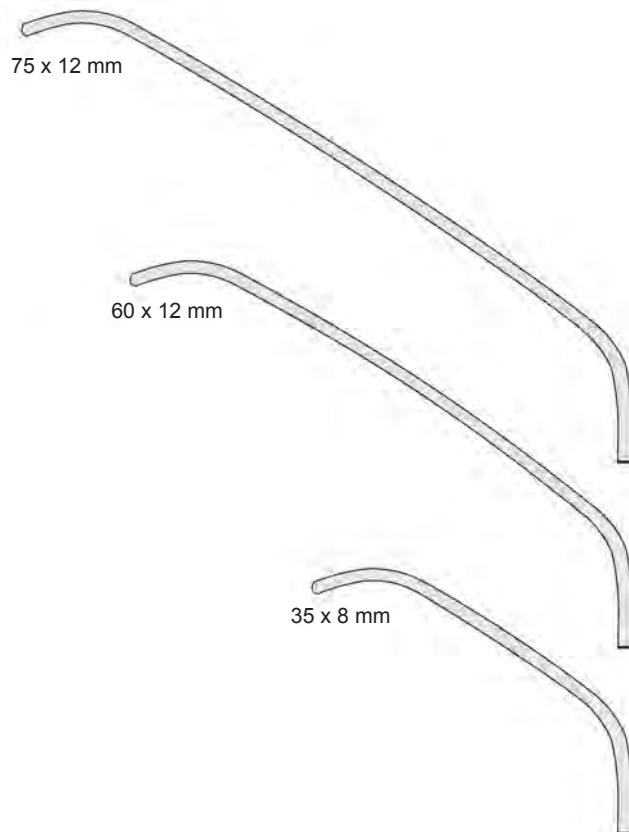


82 x 22 mm **064-390-01**  
 108 x 43 mm **064-390-02**  
 115 x 65 mm **064-390-03**

**CORYKKOS**  
 24,0 cm, 9<sup>1</sup>/<sub>2</sub>"



**ZENKER**



75 x 12 mm

60 x 12 mm

35 x 8 mm

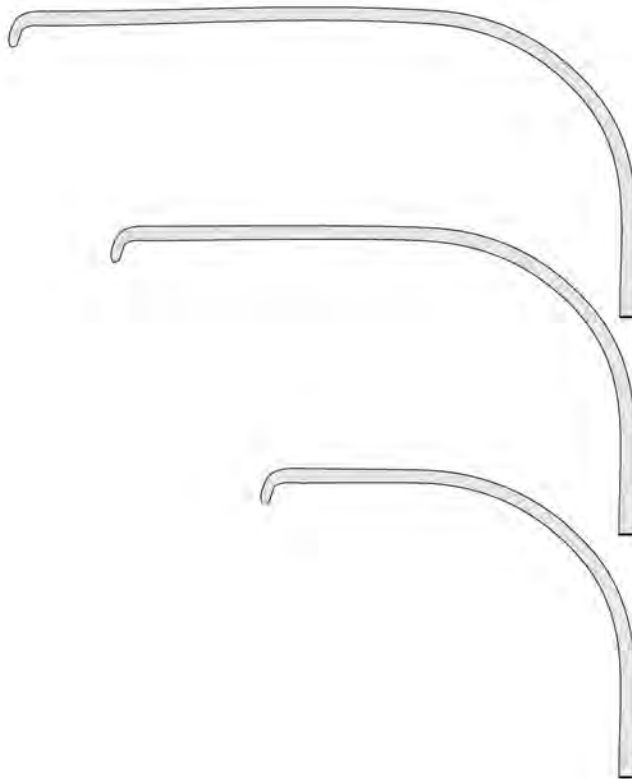
25,0 cm, 9<sup>3</sup>/<sub>4</sub>"  
**064-320-25**

26,0 cm, 10<sup>1</sup>/<sub>4</sub>"  
**064-320-26**

27,5 cm, 10<sup>3</sup>/<sub>4</sub>"  
**064-320-27**



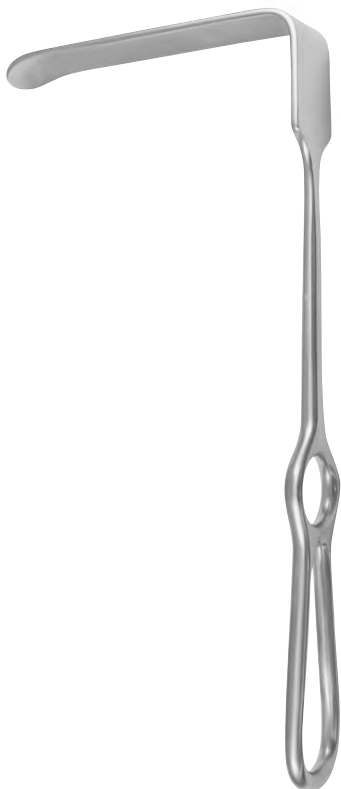
**MEYERDING**  
22,5 cm, 8<sup>3</sup>/<sub>4</sub>"



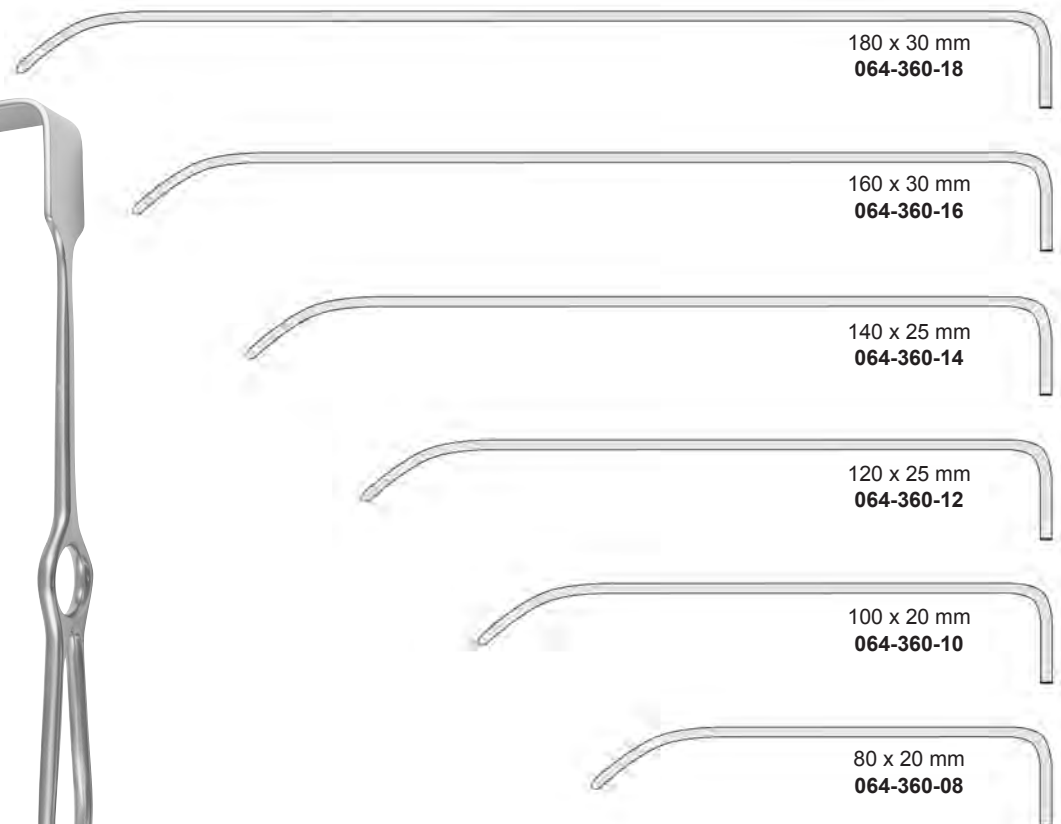
90 x 50 mm  
**064-350-50**

75 x 25 mm  
**064-350-25**

50 x 16 mm  
**064-350-16**



**BRUNNER**  
25,0 cm, 10"



180 x 30 mm  
**064-360-18**

160 x 30 mm  
**064-360-16**

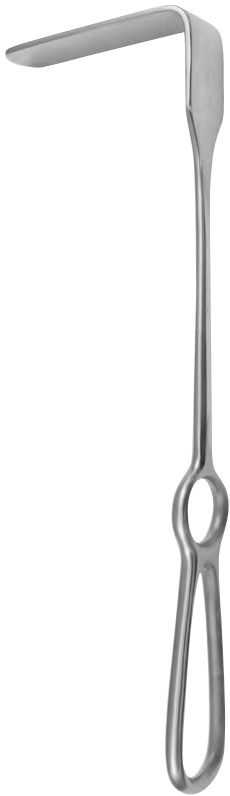
140 x 25 mm  
**064-360-14**

120 x 25 mm  
**064-360-12**

100 x 20 mm  
**064-360-10**

80 x 20 mm  
**064-360-08**

Wundhaken  
 Retractors  
 Separadores  
 Divaricatori



**BRUNNER**  
 25,0 cm, 10"



180 x 30 mm  
**064-370-18**



160 x 30 mm  
**064-370-16**



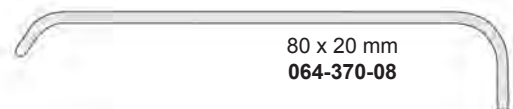
140 x 25 mm  
**064-370-14**



120 x 25 mm  
**064-370-12**



100 x 20 mm  
**064-370-10**



80 x 20 mm  
**064-370-08**



19 mm

**DEAVER**  
 18,0 cm, 7"  
**064-602-18**



22 mm

**DEAVER**  
 21,5 cm, 8½"  
**064-602-22**



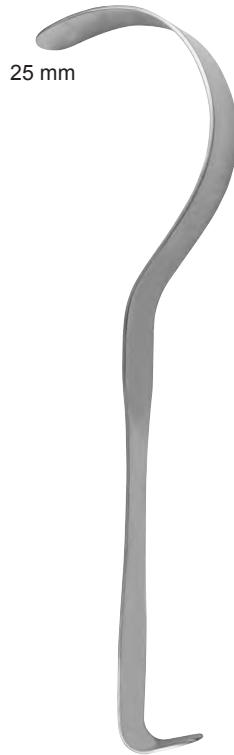
25 mm

**DEAVER**  
 23,0 cm, 9"  
**064-602-23**



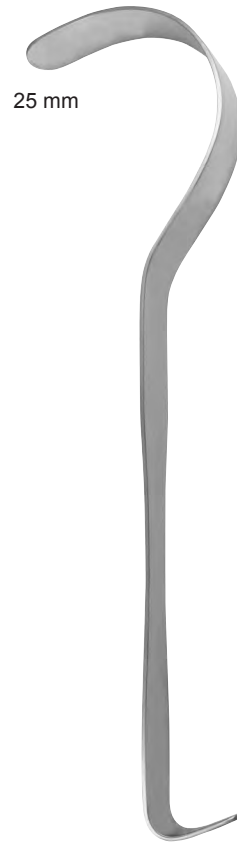
25 mm

**DEAVER**  
30,0 cm, 11<sup>3</sup>/<sub>4</sub>"  
**064-604-30**



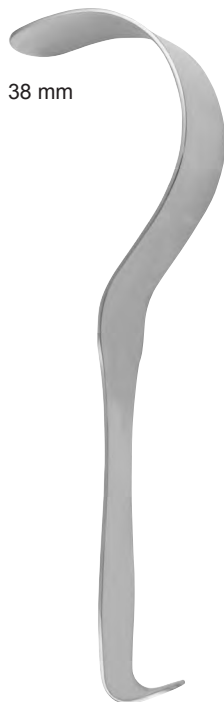
25 mm

**DEAVER**  
33,0 cm, 13"  
**064-604-33**



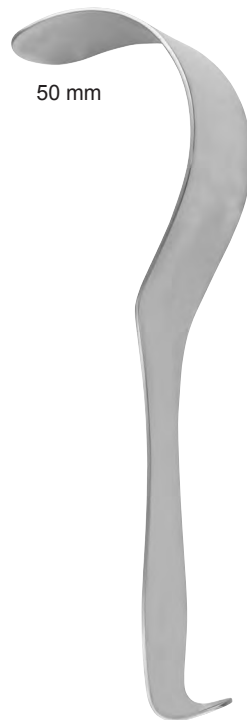
25 mm

**DEAVER**  
36,0 cm, 14<sup>1</sup>/<sub>8</sub>"  
**064-604-36**



38 mm

**DEAVER**  
30,0 cm, 11<sup>3</sup>/<sub>4</sub>"  
**064-610-38**



50 mm

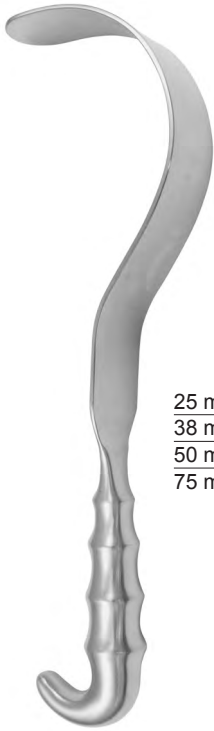
**DEAVER**  
30,0 cm, 11<sup>3</sup>/<sub>4</sub>"  
**064-610-50**



75 mm

**DEAVER**  
30,0 cm, 11<sup>3</sup>/<sub>4</sub>"  
**064-610-75**

Wundhaken  
 Retractors  
 Separadores  
 Divaricatori



25 mm **064-600-25**  
 38 mm **064-600-38**  
 50 mm **064-600-50**  
 75 mm **064-600-75**

**DEAVER**  
 30,0 cm, 11<sup>3</sup>/<sub>4</sub>"



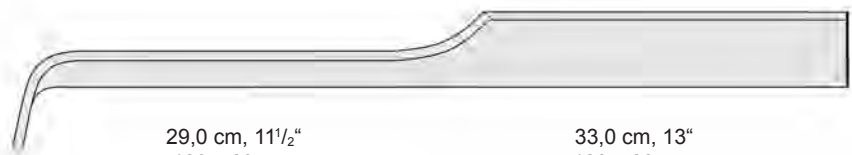
**ALLISON**  
 40 mm 30,0 cm, 11<sup>3</sup>/<sub>4</sub>" **064-700-30**  
 54 mm 32,0 cm, 12<sup>1</sup>/<sub>2</sub>" **064-700-32**



**DAVIDSON**  
 75 x 50 mm 16,0 cm, 6<sup>1</sup>/<sub>4</sub>" **064-710-50**  
 75 x 90 mm 16,0 cm, 6<sup>1</sup>/<sub>4</sub>" **064-710-90**



**ST MARKS**



29,0 cm, 11<sup>1</sup>/<sub>2</sub>"  
 130 x 60 mm  
**064-720-01**

33,0 cm, 13"  
 180 x 60 mm  
**064-720-02**



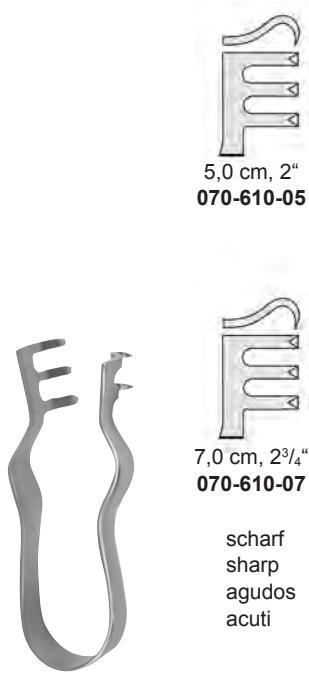
29,0 cm, 11<sup>1</sup>/<sub>2</sub>"  
 130 x 60 mm  
**064-721-01**

33,0 cm, 13"  
 180 x 60 mm  
**064-721-02**

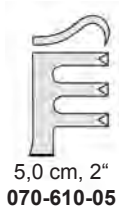
**Wundspreizer**  
**Self-Retaining Retractors**  
**Separadores con retenida automática**  
**Divaricatori autostatici**



**Wundspreizer**  
**Self-Retaining Retractors**  
**Separadores con retenida automática**  
**Divaricatori autostatici**



**FINSEN**



5,0 cm, 2"  
**070-610-05**



5,0 cm, 2"  
**070-611-05**



7,0 cm, 2<sup>3</sup>/<sub>4</sub>"  
**070-610-07**

scharf  
 sharp  
 agudos  
 acuti

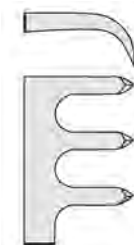


7,0 cm, 2<sup>3</sup>/<sub>4</sub>"  
**070-611-07**

stumpf  
 blunt  
 romo  
 smusso

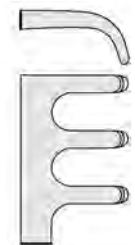


**JANSEN**  
 10,0 cm, 4"



**070-630-10**

scharf  
 sharp  
 agudos  
 acuti



**070-631-10**

stumpf  
 blunt  
 romo  
 smusso



**ALM**

scharf  
 sharp  
 agudos  
 acuti

halbscharf  
 semi-sharp  
 semi-agudos  
 semi-acuti

stumpf  
 blunt  
 romo  
 smusso



7,0 cm, 2<sup>3</sup>/<sub>4</sub>"  
 10,0 cm, 4"

**070-620-07**



**070-622-07**



**070-621-07**

**070-620-10**

**070-622-10**

**070-621-10**

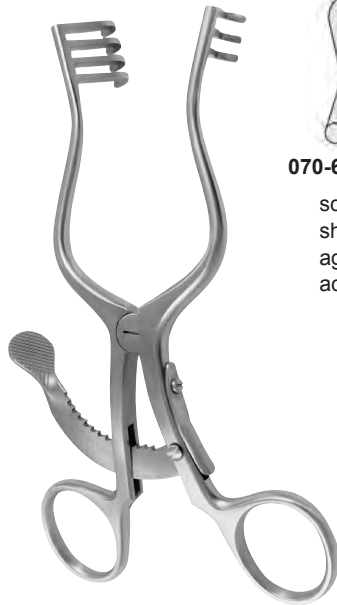


**ALLPORT**  
 9,5 cm, 3<sup>3</sup>/<sub>4</sub>"  
**070-626-09**



**IZIAL DENTAL SURGICAL**  
 Manufacturer And Exporter Of Surgical Dental & Manicure

**Wundspreizer**  
**Self-Retaining Retractors**  
**Separadores con retenida automática**  
**Divaricatori autostatici**



**070-660-14**

scharf  
sharp  
agudos  
acuti

**070-661-14**

stumpf  
blunt  
romo  
smusso

**SALP-CONTOUR**  
14,0 cm, 5½"



**070-684-16**

scharf  
sharp  
agudos  
acuti

**070-685-16**

stumpf  
blunt  
romo  
smusso

**ADSON-BABY**  
16,0 cm, 6¼"



**070-678-20**

stumpf  
blunt  
romo  
smusso



**070-679-20**

scharf  
sharp  
agudos  
acuti

**ANDERSON-ADSON**  
19,0 cm, 8"



**070-682-26**

scharf  
sharp  
agudos  
acuti

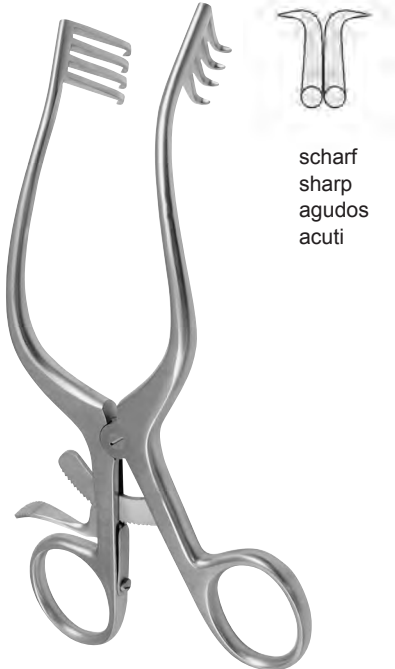


**070-683-26**

stumpf  
blunt  
romo  
smusso

**ADSON**  
26,5 cm, 10½"

Wundspreizer  
 Self-Retaining Retractors  
 Separadores con retenida automática  
 Divaricatori autostatici



scharf  
 sharp  
 agudos  
 acuti

**MOLLISON**  
 15,5 cm, 6"  
 070-674-15

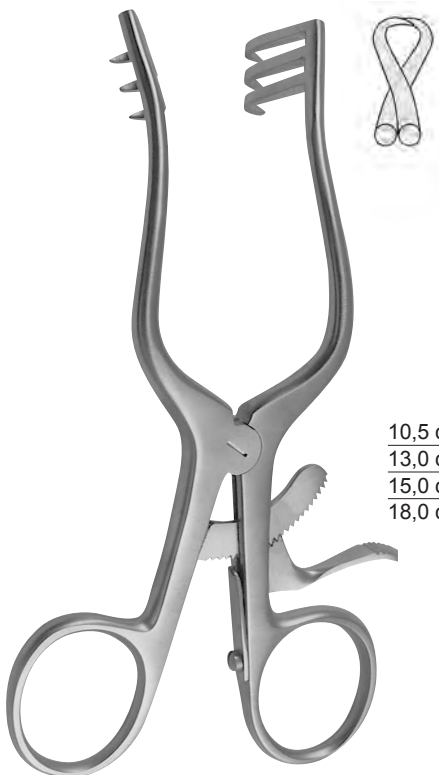


**070-800-12**  
 scharf  
 sharp  
 agudos  
 acuti



**070-801-12**  
 stumpf  
 blunt  
 romo  
 smuss

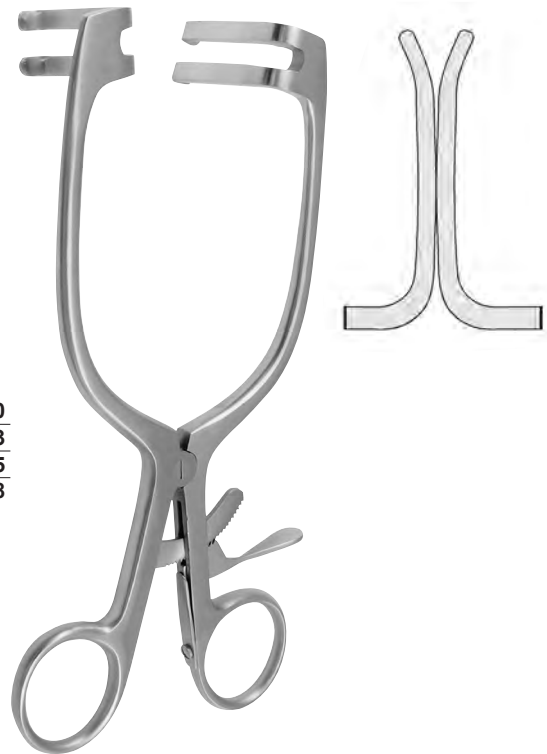
**SCHUHKNECHT**  
 12,5 cm, 5"



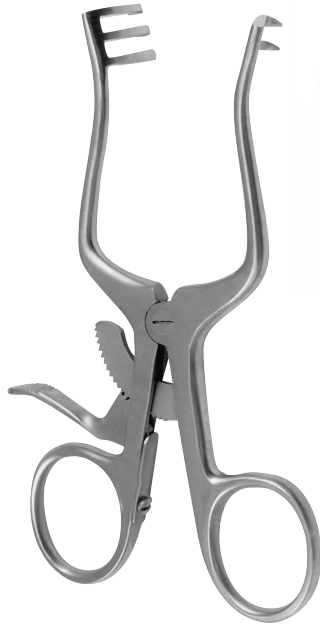
scharf      stumpf  
 sharp      blunt  
 agudos      romo  
 acuti      smusso

10,5 cm, 4 <sup>1</sup> / <sub>8</sub> "	<b>070-810-10</b>	<b>070-811-10</b>
13,0 cm, 5"	<b>070-810-13</b>	<b>070-811-13</b>
15,0 cm, 6"	<b>070-810-15</b>	<b>070-811-15</b>
18,0 cm, 7"	<b>070-810-18</b>	<b>070-811-18</b>

**WULLSTEIN**



**MAYO-ADAMS**  
 16,5 cm, 6<sup>1</sup>/<sub>2</sub>"  
 070-822-17



**WEITLANER-LOKTITE**  
10,5 cm, 4<sup>1</sup>/<sub>8</sub>"



**070-650-10**  
scharf  
sharp  
agudos  
acuti



**070-651-10**  
stumpf  
blunt  
romo  
smusso



**WEITLANER**  
13,0 cm, 5"



**070-670-13**  
scharf  
sharp  
agudos  
acuti



**070-671-13**  
stumpf  
blunt  
romo  
smusso



**WEITLANER**  
16,5 cm, 6<sup>1</sup>/<sub>2</sub>"



**070-670-16**  
scharf  
sharp  
agudos  
acuti



**070-671-16**  
stumpf  
blunt  
romo  
smusso



**WEITLANER**  
20,0 cm, 8"



**070-670-20**  
scharf  
sharp  
agudos  
acuti



**070-671-20**  
stumpf  
blunt  
romo  
smusso

**Wundspreizer**  
**Self-Retaining Retractors**  
**Separadores con retenida automática**  
**Divaricatori autostatici**



**WEITLANER**  
 24,0 cm, 9 1/2"



**070-670-24**

scharf  
 sharp  
 agudos  
 acuti



**070-671-24**

stumpf  
 blunt  
 romo  
 smusso



**PLESTER**  
 13,0 cm, 5"



**070-830-13**

scharf  
 sharp  
 agudos  
 acuti

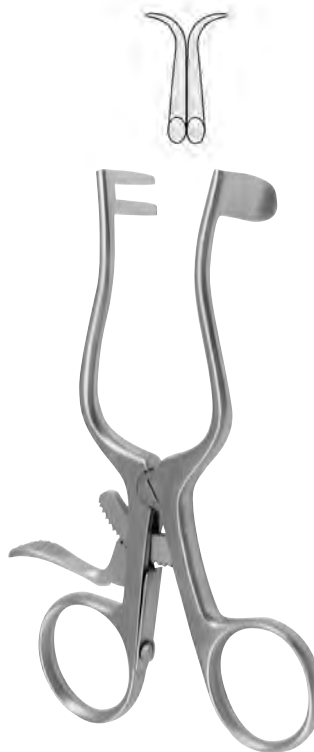


**070-831-13**

stumpf  
 blunt  
 romo  
 smusso



**MILLIGAN**  
 13,0 cm, 5"  
**070-840-13**



**PLESTER**  
 11,0 cm, 4 3/8"  
**070-672-11**



**PLESTER**  
 11,0 cm, 4 3/8"  
**070-673-11**



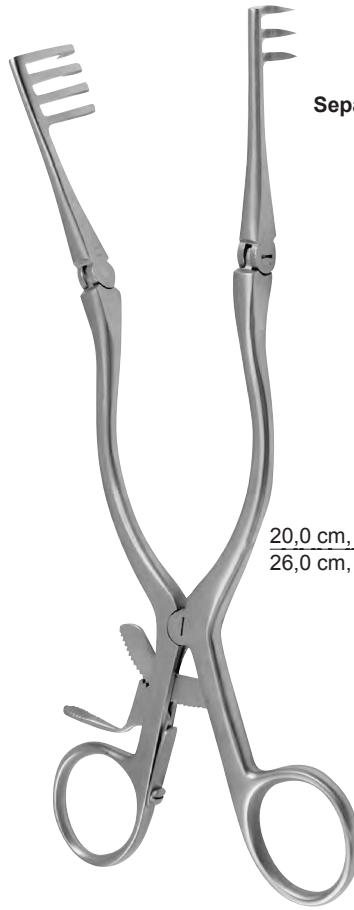
**IZIAL DENTAL SURGICAL**

Manufacturer And Exporter Of Surgical Dental & Manicure

**Wundspreizer**  
**Self-Retaining Retractors**  
**Separadores con retenida automática**  
**Divaricatori autostatici**

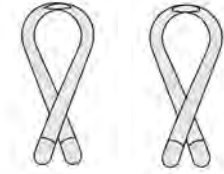


**WEITLANER-BABY**  
13,0 cm, 5"  
070-850-13

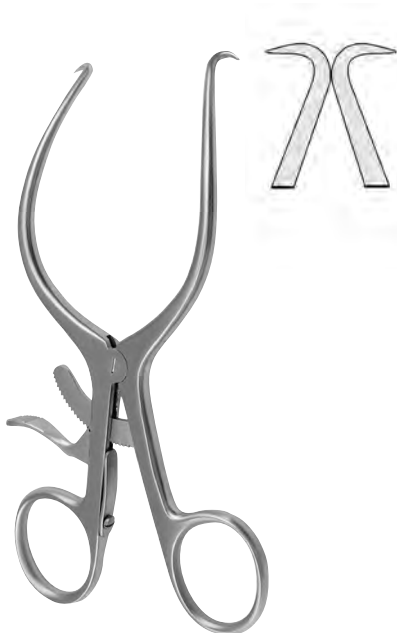


**ADSON  
(CONE)**

20,0 cm, 8" **070-860-20** **070-861-20**  
26,0 cm, 10 1/4" **070-860-26** **070-861-26**



scharf      stumpf  
sharp      blunt  
agudos      romo  
acuti      smusso



**GELPI**  
13,5 cm, 5 3/8"  
070-202-14

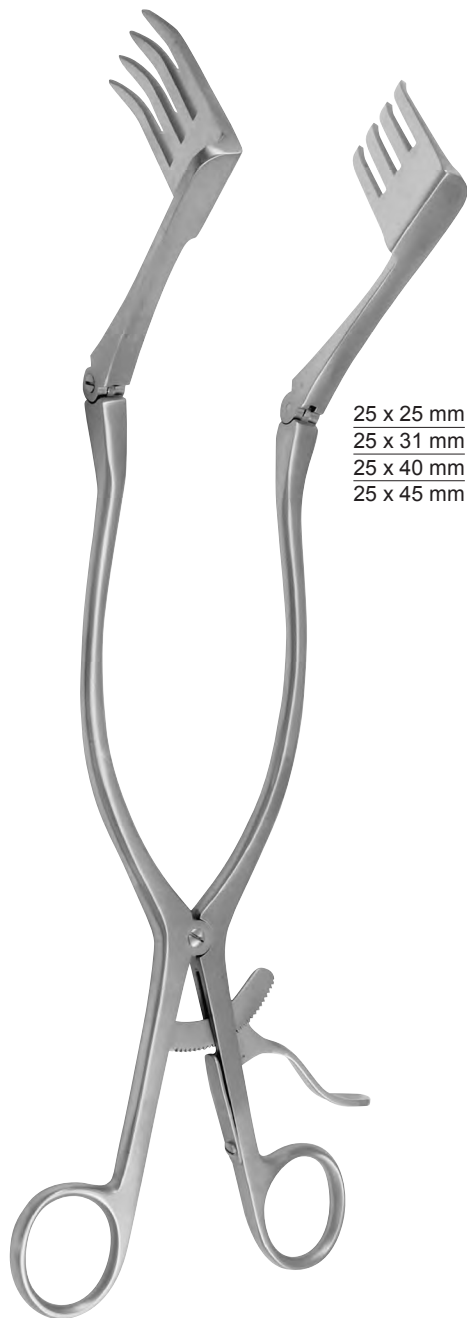


**GELPI**  
19,0 cm, 7 1/2"  
070-202-19

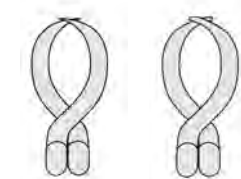


**GELPI-LOKTITE**  
18,0 cm, 7 1/2"  
070-250-19

Wundspreizer  
 Self-Retaining Retractors  
 Separadores con retenida automática  
 Divaricatori autostatici



25 x 25 mm  
 25 x 31 mm  
 25 x 40 mm  
 25 x 45 mm

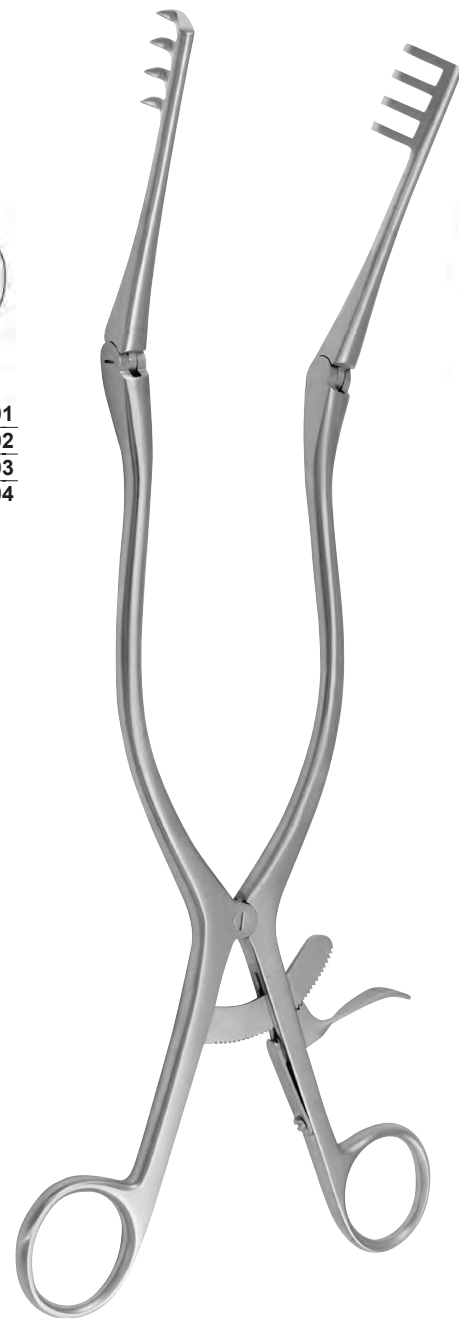


<b>070-870-01</b>	<b>070-871-01</b>
<b>070-870-02</b>	<b>070-871-02</b>
<b>070-870-03</b>	<b>070-871-03</b>
<b>070-870-04</b>	<b>070-871-04</b>

scharf  
 sharp  
 agudos  
 acuti

stumpf  
 blunt  
 romo  
 smusso

**BECKMANN-ADSON**  
 31,0 cm, 12 1/4"



**070-690-31**  
 scharf  
 sharp  
 agudos  
 acuti

**BECKMANN**  
 31,0 cm, 12 1/4"



**IZIAL DENTAL SURGICAL**  
Manufacturer And Exporter Of Surgical Dental & Manicure

**Wundspreizer**  
**Self-Retaining Retractors**  
**Separadores con retenida automática**  
**Divaricatori autostatici**



**070-691-32**

stumpf  
blunt  
romo  
smusso

**BECKMANN**  
32,0 cm, 12½"

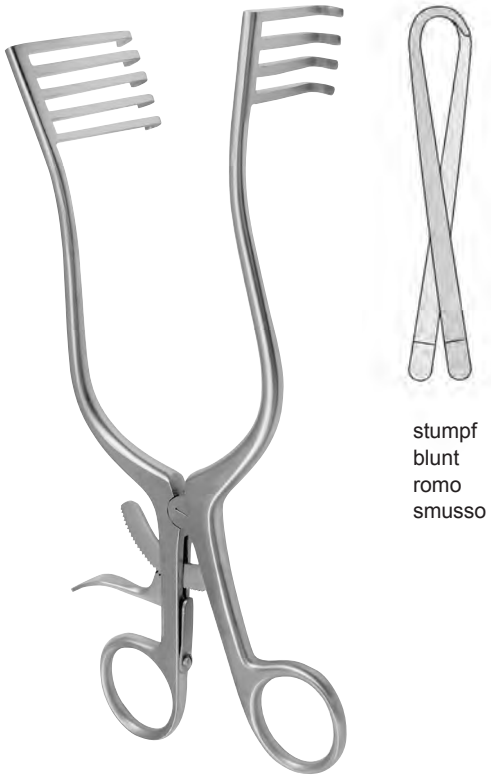


**DE BAKEY**

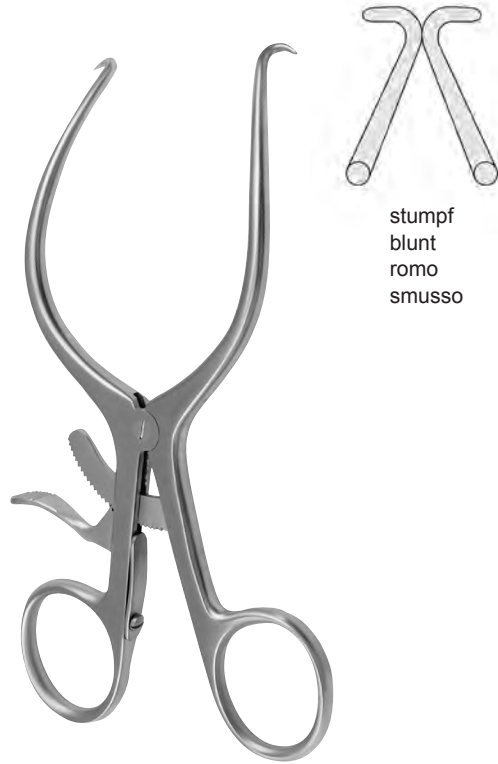
10,0 cm, 4" **070-240-10**  
14,0 cm, 5½" **070-240-14**



Wundspreizer  
 Self-Retaining Retractors  
 Separadores con retenida automática  
 Divaricatori autostatici



**NORFOLK AND NORWICH**  
 22,0 cm, 8<sup>5</sup>/<sub>8</sub>"  
 070-401-22



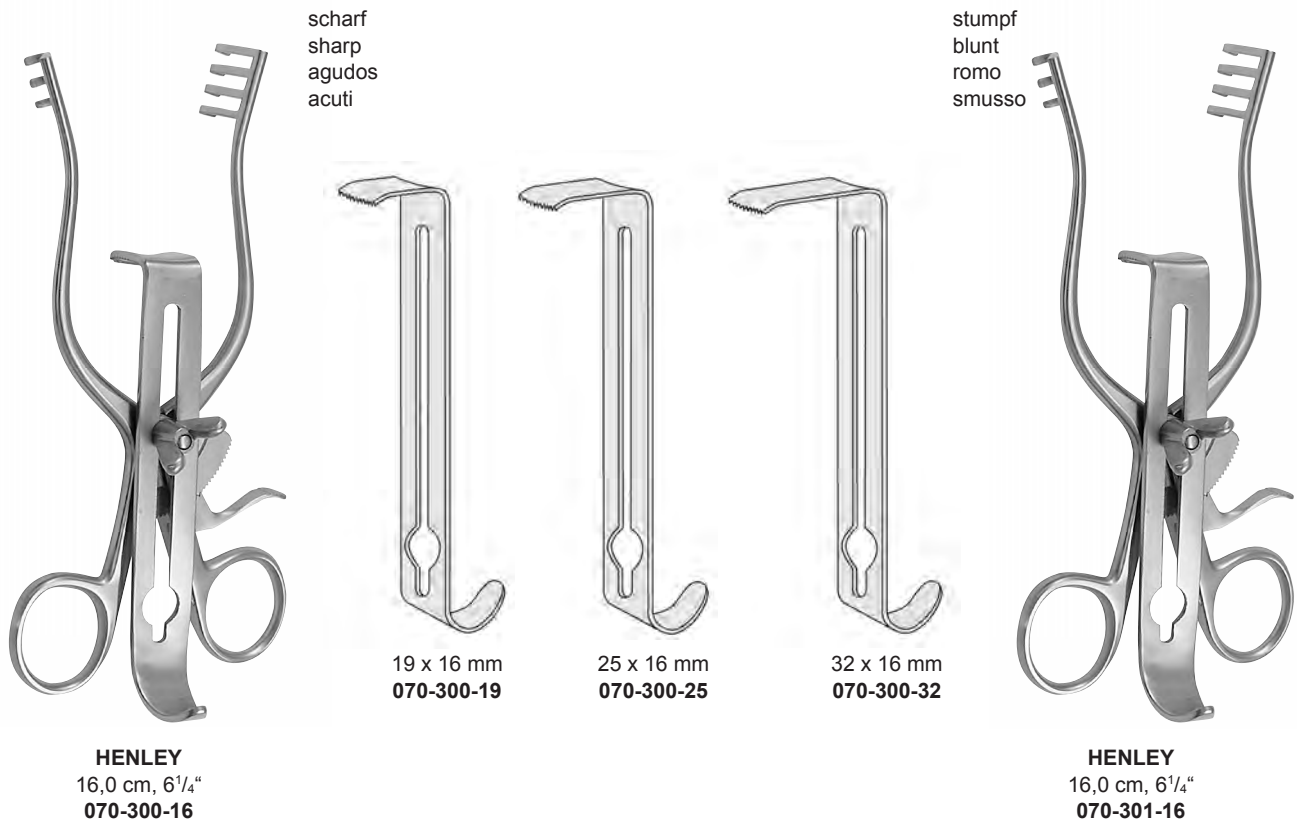
**JACKSON BURROWS**  
 17,5 cm, 7"  
 070-411-17



**RICHTER**  
 17,0 cm, 6<sup>3</sup>/<sub>4</sub>"  
 070-420-17



**JOLL (FRIEDMAN)**  
 15,5 cm, 6"  
 070-430-15



**HENLEY  
070-300-00**

komplett, bestehend aus:

- 1 Sperrer mit Seitenvalven, scharf (30-1300-16)
- 1 Mittelvalve 19 x 16 mm (30-1300-19)
- 1 Mittelvalve 25 x 16 mm (30-1300-25)
- 1 Mittelvalve 32 x 16 mm (30-1300-32)

complete, consisting of:

- 1 Spreader with lateral valves, sharp (30-1300-16)
- 1 Central valve 19 x 16 mm (30-1300-19)
- 1 Central valve 25 x 16 mm (30-1300-25)
- 1 Central valve 32 x 16 mm (30-1300-32)

completo, compuesto of:

- 1 Separador con valvas laterales, agudas (30-1300-16)
- 1 Valva central 19 x 16 mm (30-1300-19)
- 1 Valva central 25 x 16 mm (30-1300-25)
- 1 Valva central 32 x 16 mm (30-1300-32)

completo, composto da:

- 1 Divaricatore con valve laterali, acuto (30-1300-16)
- 1 Valva centrale 19 x 16 mm (30-1300-19)
- 1 Valva centrale 25 x 16 mm (30-1300-25)
- 1 Valva centrale 32 x 16 mm (30-1300-32)

**HENLEY  
070-301-00**

komplett, bestehend aus:

- 1 Sperrer mit Seitenvalven, stumpf (30-1301-16)
- 1 Mittelvalve 19 x 16 mm (30-1300-19)
- 1 Mittelvalve 25 x 16 mm (30-1300-25)
- 1 Mittelvalve 32 x 16 mm (30-1300-32)

complete, consisting of:

- 1 Spreader with lateral valves, blunt (30-1301-16)
- 1 Central valve 19 x 16 mm (30-1300-19)
- 1 Central valve 25 x 16 mm (30-1300-25)
- 1 Central valve 32 x 16 mm (30-1300-32)

completo, compuesto of:

- 1 Separador con valvas laterales, romas (30-1301-16)
- 1 Valva central 19 x 16 mm (30-1300-19)
- 1 Valva central 25 x 16 mm (30-1300-25)
- 1 Valva central 32 x 16 mm (30-1300-32)

completo, composto da:

- 1 Divaricatore con valve laterali, smusso (30-1301-16)
- 1 Valva centrale 19 x 16 mm (30-1300-19)
- 1 Valva centrale 25 x 16 mm (30-1300-25)
- 1 Valva centrale 32 x 16 mm (30-1300-32)

Wundspreizer, Bauchdeckenhalter  
 Self-Retaining Retractors, Abdominal Retractors  
 Separadores con retenida automática, Separadores abdominales  
 Divaricatori autostatici, Divaricatori addominali



**MAYO-ADAMS**  
 17,0 cm, 6<sup>3</sup>/<sub>4</sub>"  
 070-320-17



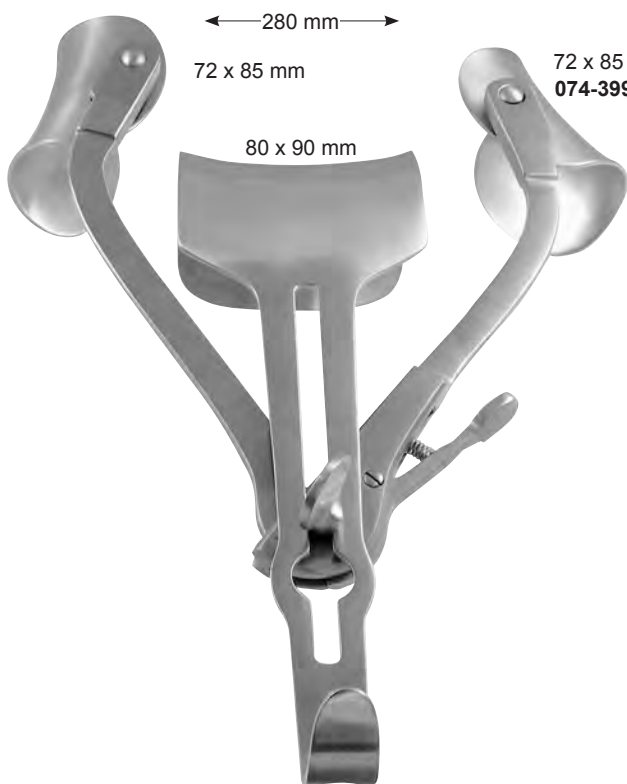
**COLLIN-BABY**  
 18,0 cm, 7"  
 070-330-18

30 x 44 mm  
 070-330-30

Wechselvalven  
 Exchangeable blades  
 Valvas intergambiabili  
 Valve intercambiabili



23 x 44 mm  
 070-330-23



**RICARD**  
 28,0 cm, 11"  
 074-310-28



**RICARD**  
 30,0 cm, 12"  
 074-312-30



**IZIAL DENTAL SURGICAL**  
Manufacturer And Exporter Of Surgical Dental & Manicure

**Wundspreizer, Bauchdeckenhalter**  
**Self-Retaining Retractors, Abdominal Retractors**  
**Separadores con retenida automática, Separadores abdominales**  
**Divaricatori autostatici, Divaricatori addominali**

38 x 62 mm  
074-398-10

← 135-160 mm →



**COLLIN**  
23,5 cm, 9 1/4"  
074-330-24

40 x 80 mm

← 135-160 mm →



**COLLIN**  
23,5 cm, 9 1/4"  
074-332-24

40 x 80 mm  
074-398-11

60 x 80 mm  
074-398-13

← 135-160 mm →



**COLLIN**  
23,5 cm, 9 1/4"  
074-334-24

Wundspreizer, Bauchdeckenhalter  
 Self-Retaining Retractors, Abdominal Retractors  
 Separadores con retenida automática, Separadores abdominales  
 Divaricatori autostatici, Divaricatori addominali



38 x 62 mm    **074-399-01**  
40 x 80 mm    **074-399-02**  
60 x 80 mm    **074-399-03**



50 x 58 mm    **074-399-10**  
60 x 80 mm    **074-399-13**  
72 x 85 mm    **074-399-14**



**074-399-23**  
 60 x 80 mm



**074-399-33**  
 60 x 80 mm



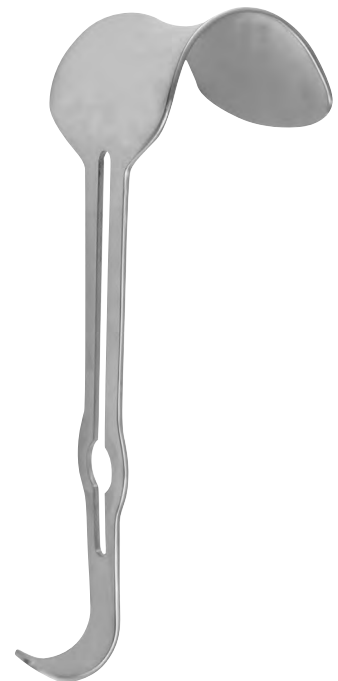
58 x 50 mm    **074-398-01**  
80 x 60 mm    **074-398-02**  
85 x 72 mm    **074-398-03**



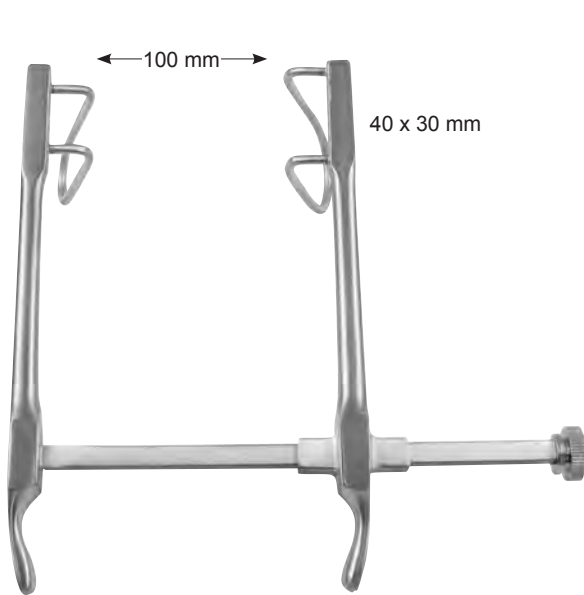
62 x 38 mm    **074-398-10**  
80 x 38 mm    **074-398-11**  
100 x 38 mm    **074-398-12**  
80 x 38 mm    **074-398-13**



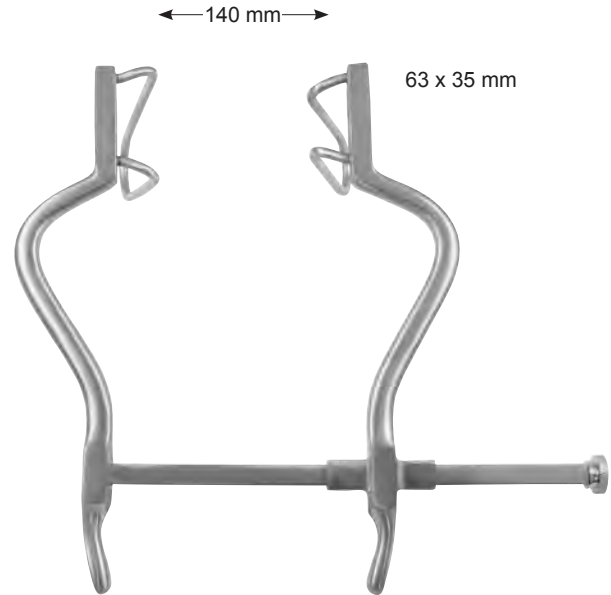
**COLLIN**  
55 x 55 mm    **074-331-01**  
55 x 65 mm    **074-331-02**  
55 x 75 mm    **074-331-03**



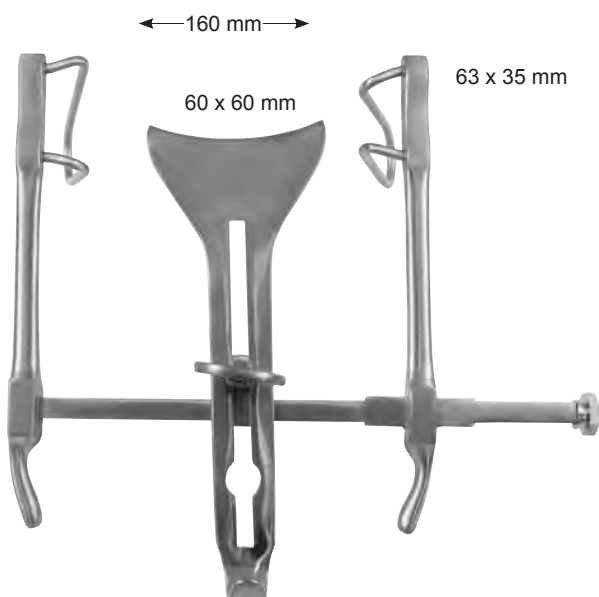
**RICARD**  
65 x 50 mm    **074-310-01**  
70 x 55 mm    **074-310-02**  
90 x 80 mm    **074-310-03**



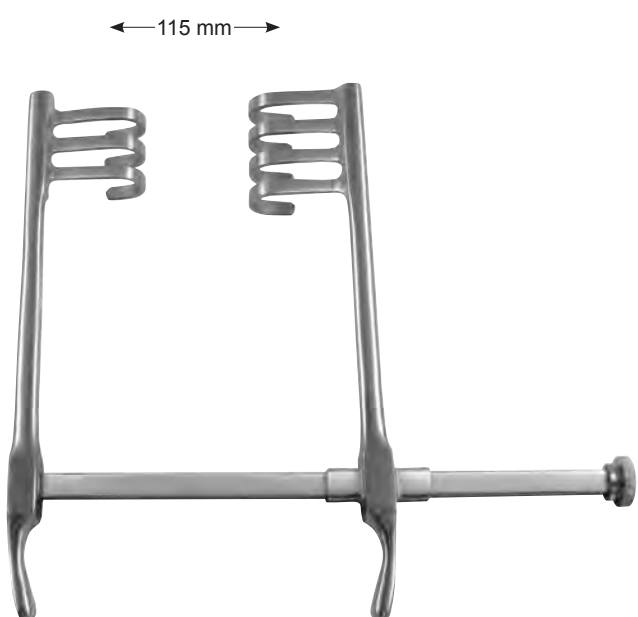
**GOSSET**  
**074-400-10**



**GOSSET**  
**074-412-14**

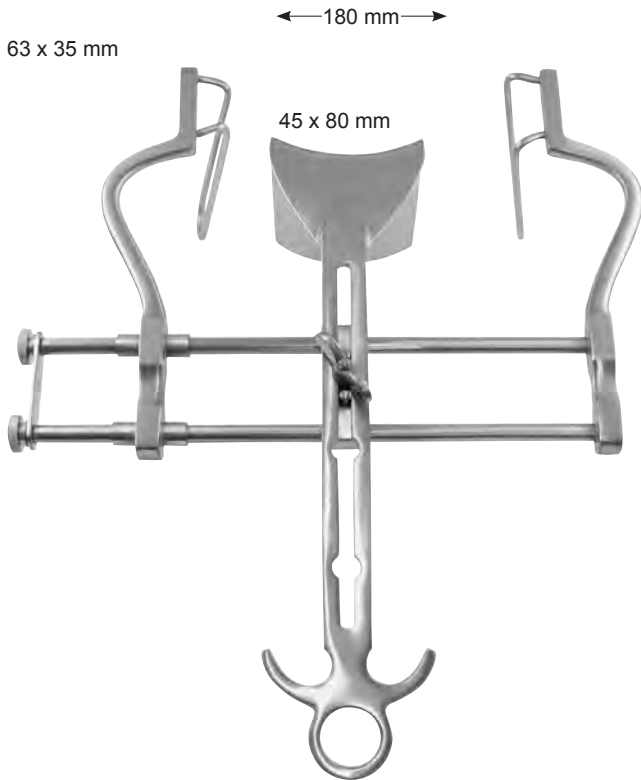


**GOSSET**  
**074-414-16**

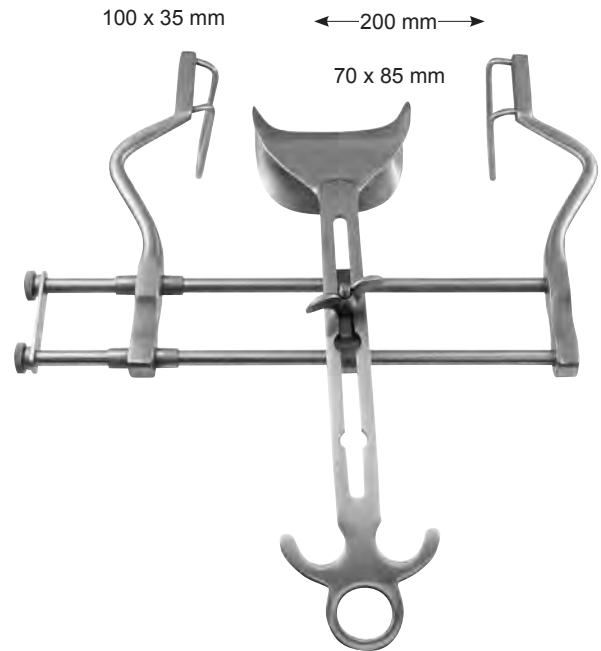


**ABADIE**  
**074-450-12**

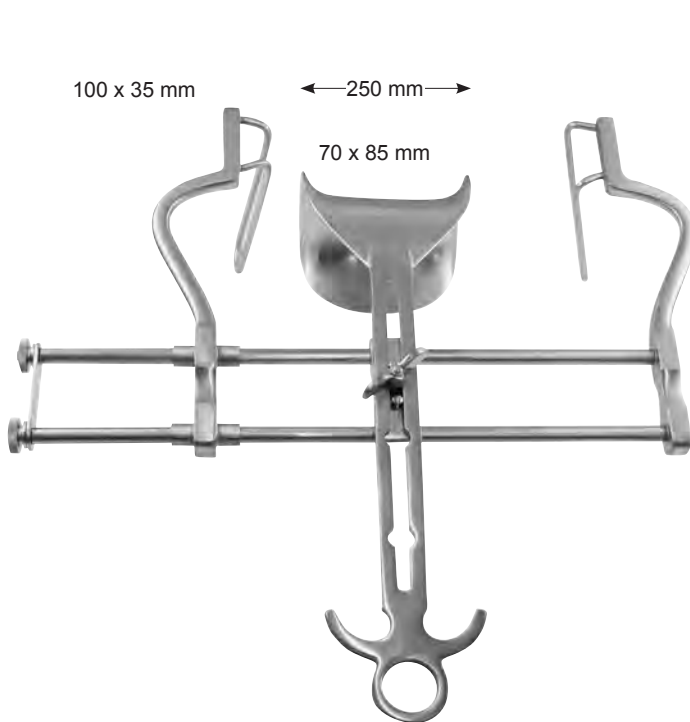
**Bauchdeckenhalter**  
**Abdominal Retractors**  
**Separadores abdominales**  
**Divaricatori addominali**



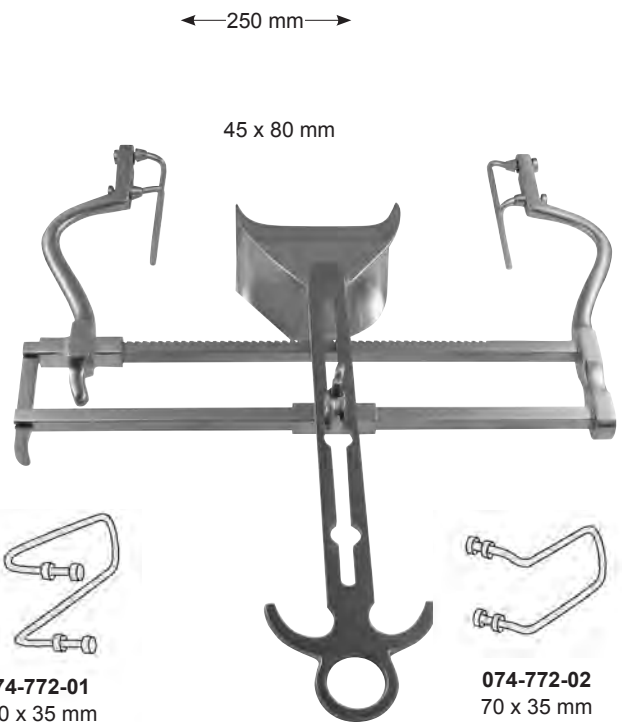
**BALFOUR**  
**074-764-18**



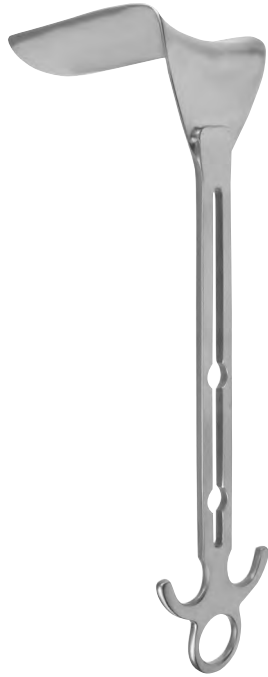
**BALFOUR**  
**074-768-20**



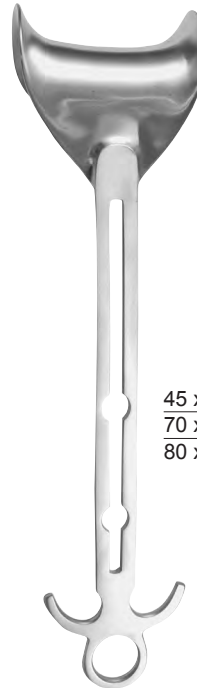
**BALFOUR**  
**074-768-25**



**BALFOUR US-TYPE**  
**074-772-25**

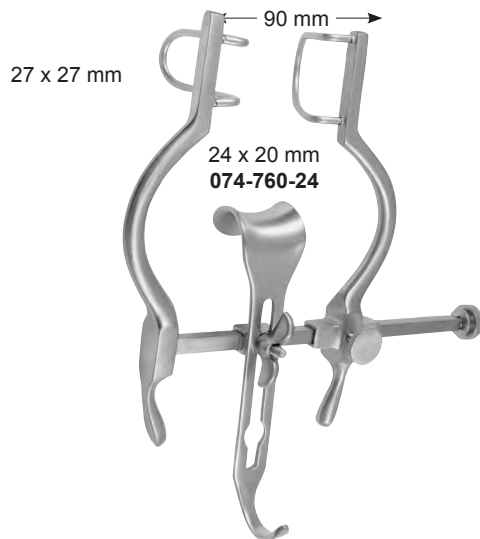


**BALFOUR**  
100 x 70 mm  
074-799-70

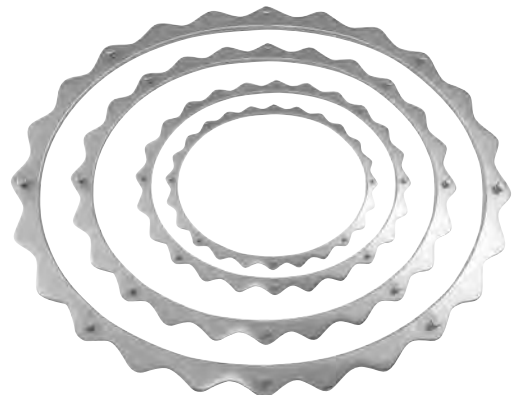


**BALFOUR**

45 x 80 mm	<b>074-798-01</b>
70 x 85 mm	<b>074-798-02</b>
80 x 90 mm	<b>074-798-03</b>



**BALFOUR**  
074-760-09



Ø 180 mm, 7"	<b>074-850-18</b>
Ø 230 mm, 9"	<b>074-850-23</b>
Ø 305 mm, 12"	<b>074-850-30</b>
455 x 330 mm	<b>074-850-45</b>



geschwärzt, black finish, negra, nera;



**074-859-02**  
51 x 38 mm



**074-859-03**  
70 x 60 mm



**074-859-05**  
114 x 60 mm

geschwärzt, black finish, negra, nera



**074-859-06**  
19 x 76 mm



**074-859-07**  
38 x 102 mm



**074-859-08**  
57 x 89 mm

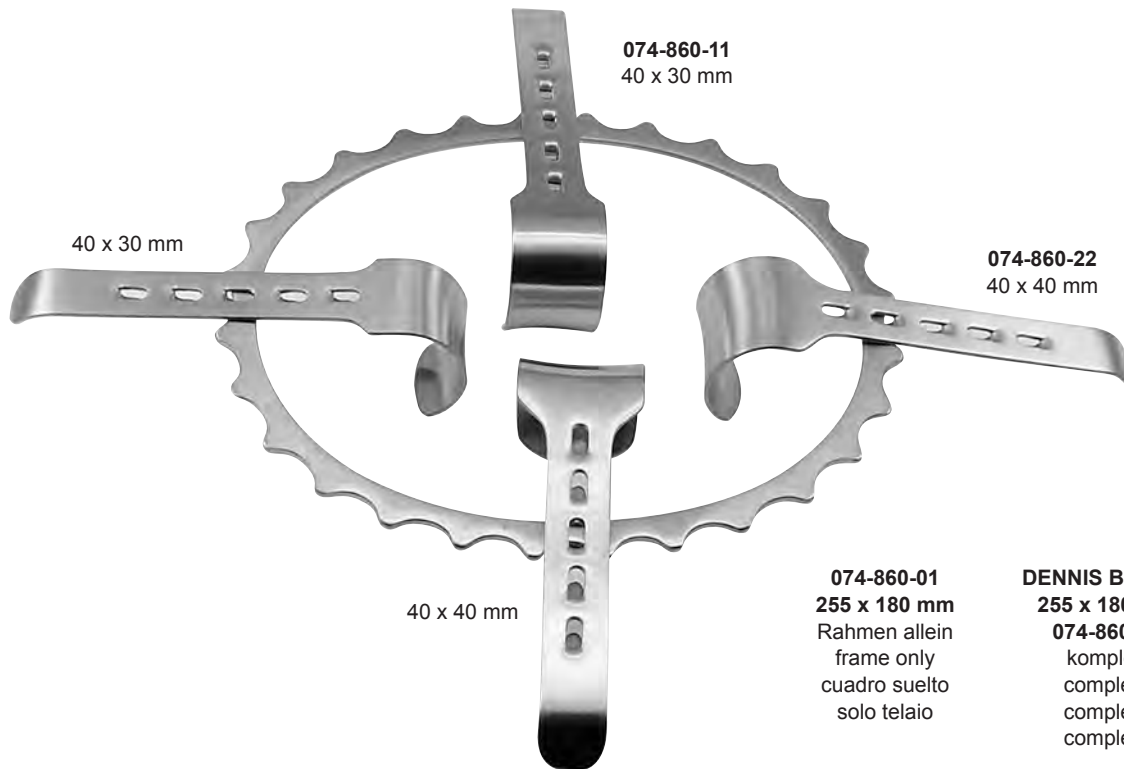


**074-859-09**  
57 x 114 mm



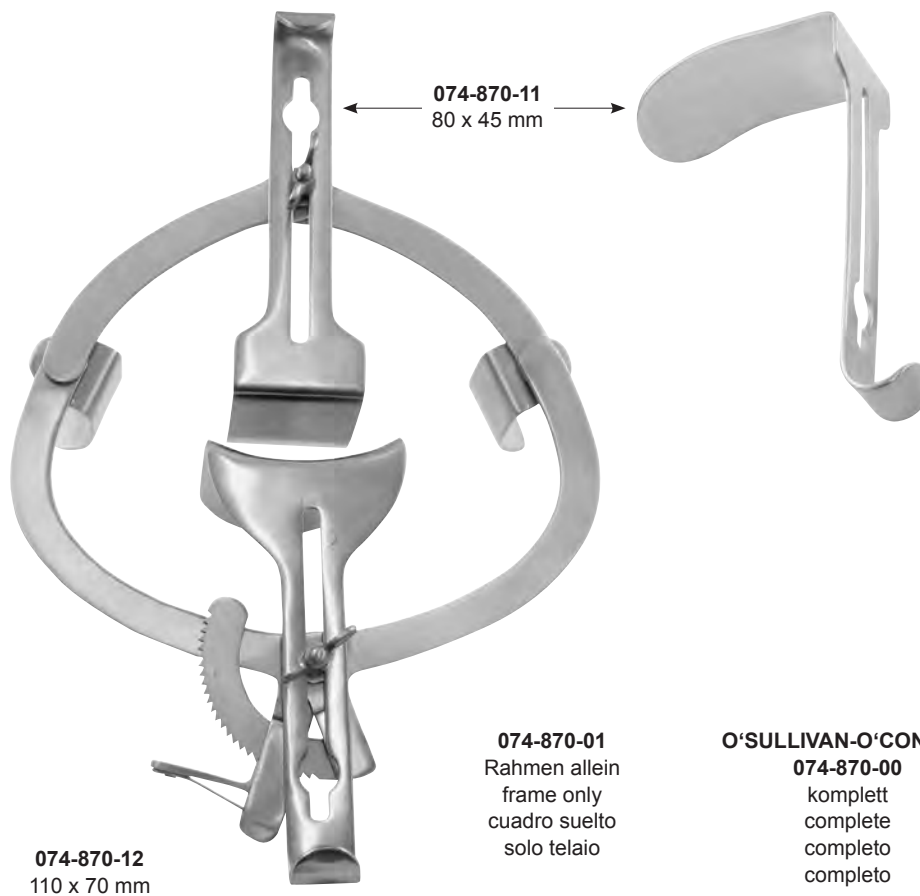
**IZIAL DENTAL SURGICAL**  
Manufacturer And Exporter Of Surgical Dental & Manicure

Bauchdeckenhalter  
Abdominal Retractors  
Separadores abdominales  
Divaricatori addominali  
Расширители для брюшины



**074-860-01**  
255 x 180 mm  
Rahmen allein  
frame only  
cuadro suelto  
solo telaio

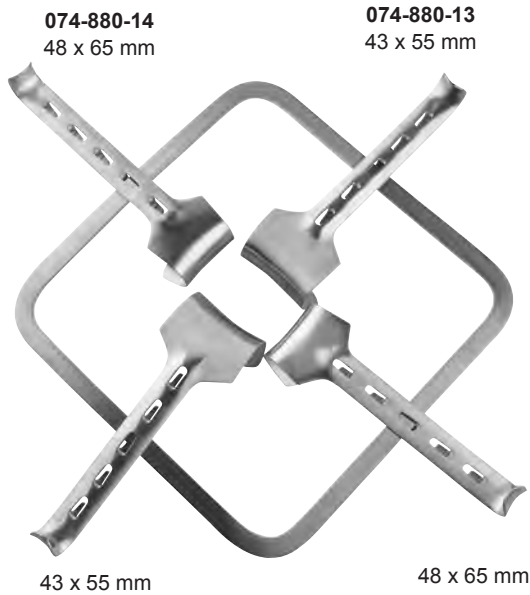
**DENNIS BROWN**  
255 x 180 mm  
**074-860-00**  
komplett  
complete  
completo  
completo



**074-870-01**  
Rahmen allein  
frame only  
cuadro suelto  
solo telaio

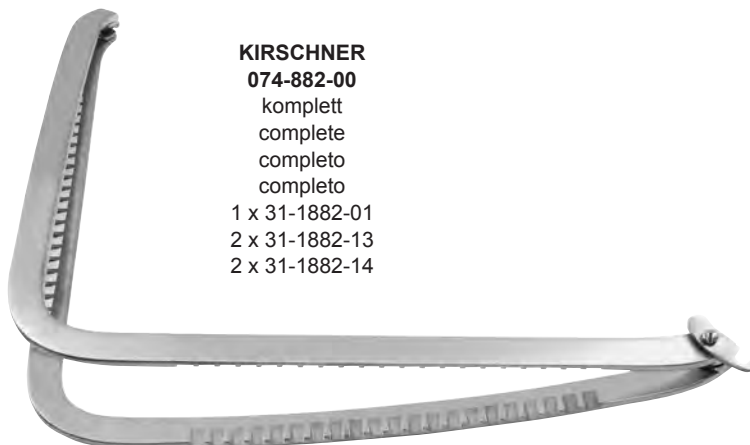
**O'SULLIVAN-O'CONNOR**  
**074-870-00**  
komplett  
complete  
completo  
completo

**Bauchdeckenhalter**  
**Abdominal Retractors**  
**Separadores abdominales**  
**Divaricatori addominali**



- |                   |               |                   |
|-------------------|---------------|-------------------|
| <b>074-880-01</b> | 250 x 250 mm  | <b>KIRSCHNER</b>  |
| <b>074-880-02</b> | 300 x 320 mm  | <b>074-880-00</b> |
| <b>074-880-03</b> | 300 x 380 mm  | komplett          |
|                   | Rahmen allein | complete          |
|                   | frame only    | completo          |
|                   | cuadro suelto | completo          |
|                   | solo telaio   | 1 x 31-1880-01    |
|                   |               | 2 x 31-1880-13    |
|                   |               | 2 x 31-1880-14    |

**074-882-01**  
 255 x 255 mm  
 zusammenlegbarer Rahmen, allein  
 folding frame, only  
 cuadro plegable, suelto  
 telaio pieghevole, solo



**KIRSCHNER**  
**074-882-00**  
 komplett  
 complete  
 completo  
 completo  
 1 x 31-1882-01  
 2 x 31-1882-13  
 2 x 31-1882-14



- |            |                   |
|------------|-------------------|
| 43 x 55 mm | <b>074-880-13</b> |
| 48 x 65 mm | <b>074-880-14</b> |
| 80 x 90 mm | <b>074-880-15</b> |
| 90 x 65 mm | <b>074-880-16</b> |
| 98 x 95 mm | <b>074-880-17</b> |

**KIRSCHNER**



**KIRSCHNER**  
60 x 82 mm  
**074-880-11**

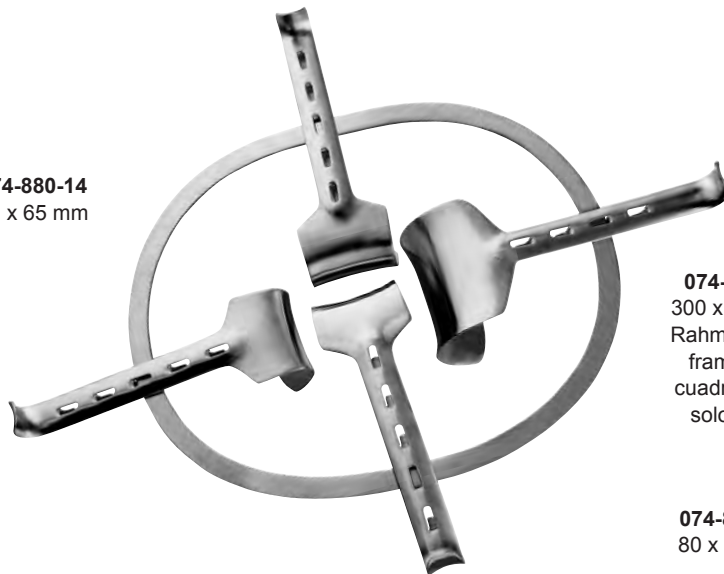


**KIRSCHNER-BALFOUR**  
83 x 82 mm  
**074-880-12**



**KIRSCHNER**  
98 x 51 mm **074-880-20**  
105 x 38 mm **074-880-21**

**074-880-14**  
48 x 65 mm

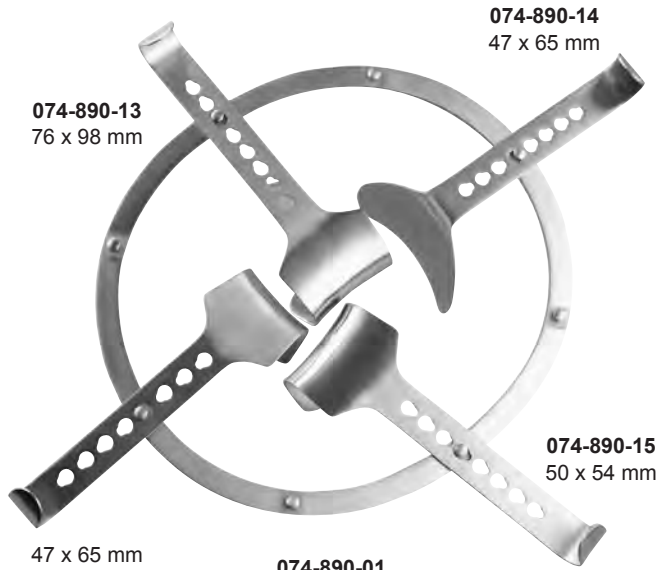


**074-890-00**  
300 x 240 mm  
Rahmen allein  
frame only  
cuadro suelto  
solo telaio

**074-880-15**  
80 x 90 mm

**KIRSCHNER, oval**  
**074-884-00**  
komplett, complete, completo, comple to  
1 x 31-1884-01  
3 x 31-1884-14  
1 x 31-1884-15  
1 x 31-1884-20  
1 x 31-1884-21

**Bauchdeckenhalter**  
**Abdominal Retractors**  
**Separadores abdominales**  
**Divaricatori addominali**



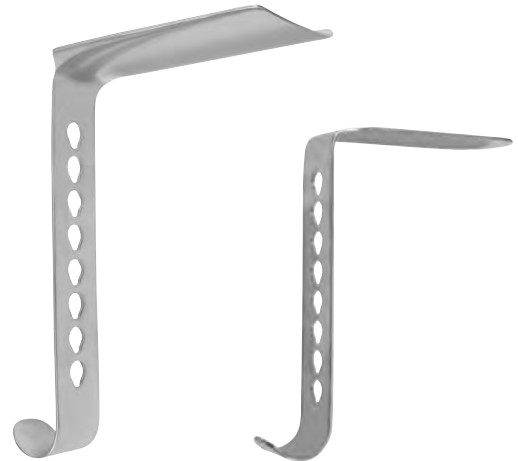
**074-890-13**  
76 x 98 mm

**074-890-14**  
47 x 65 mm

**074-890-15**  
50 x 54 mm

47 x 65 mm

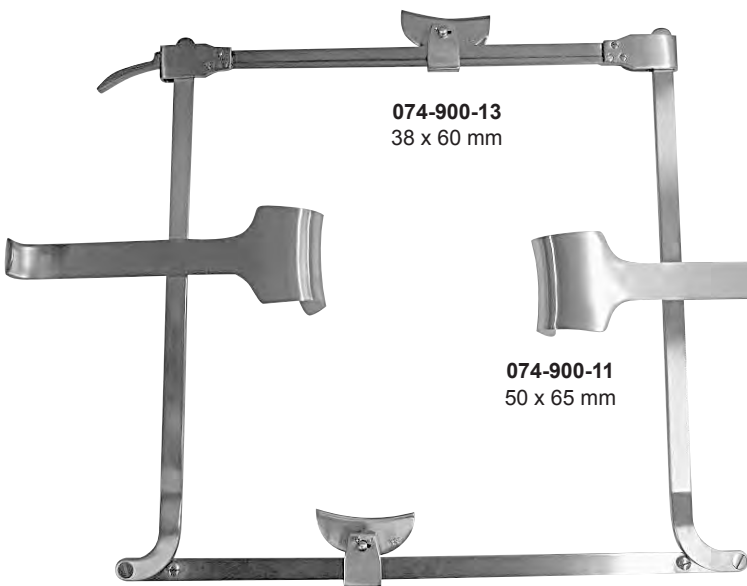
**074-890-01**  
275 x 250 mm  
Rahmen allein  
frame only  
cuadro suelto  
solo telaio



**074-890-11**  
98 x 52 mm

**074-890-12**  
105 x 35 mm

**074-900-01**  
300 x 300 mm  
zusammenlegbarer Rahmen, allein  
folding frame, only  
cuadro piegable, suelto  
telaio pieghevole, solo



**074-900-13**  
38 x 60 mm

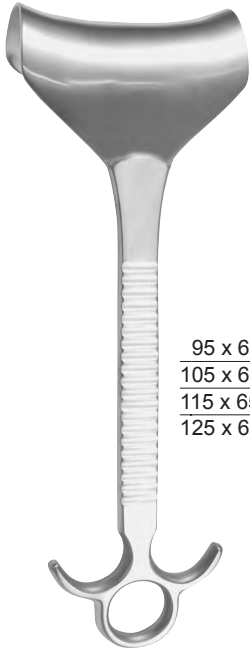
**074-900-11**  
50 x 65 mm



38 x 60 mm **074-900-13**  
45 x 80 mm **074-900-14**

50 x 65 mm **074-900-11**  
60 x 85 mm **074-900-12**

**FRANZ**  
**074-900-00**  
komplett  
complete  
completo  
completo  
1 x 31-1900-01  
2 x 31-1900-11  
2 x 31-1900-13



**DOYEN**  
28,0 cm, 11"

95 x 60 mm **074-910-11**  
105 x 65 mm **074-910-12**  
115 x 65 mm **074-910-13**  
125 x 65 mm **074-910-14**

für / for / para / per  
074-910-11  
074-910-14

Kette mit Gewicht  
Chain with weight  
Cadena con pesa  
Catena con peso



**074-915-30**  
78,5 cm, 31"

53,0 cm, 21"

66,0 cm, 26"

Befestigungsgestell  
Mounting frame  
Bastidor para la fijación  
Telaio di supporto per il fissaggio

**ROCHARD**  
**074-920-01**

53,0 cm, 21"

66,0 cm, 26"

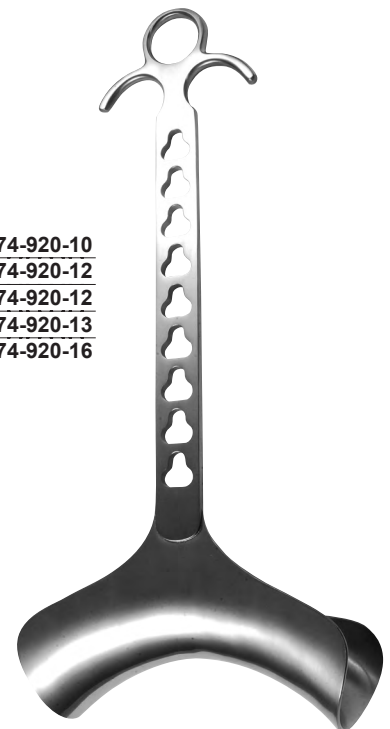
Befestigungsgestell  
Mounting frame  
Bastidor para la fijación  
Telaio di supporto per il fissaggio

**ROCHARD**  
**074-920-02**



**ROCHARD**  
28,0 cm, 11"  
**074-920-20**

95 x 48 mm **074-920-10**  
105 x 48 mm **074-920-12**  
115 x 48 mm **074-920-12**  
125 x 48 mm **074-920-13**  
155 x 48 mm **074-920-16**



**ROCHARD**  
28,0 cm, 11"

**Bauchspatel**  
**Abdominal Spatulas**  
**Espátulas abdominales**  
**Spatole addominali**



biegsam  
 malleable  
 maleable  
 malleabile

- 200 x 6 mm **078-210-06**
- 200 x 12 mm **078-210-12**
- 200 x 17 mm **078-210-17**
- 200 x 20 mm **078-210-20**
- 200 x 25 mm **078-210-25**

**RIBBON**



biegsam  
 malleable  
 maleable  
 malleabile

- 330 x 13 mm **078-170-13**
- 330 x 25 mm **078-170-25**
- 330 x 32 mm **078-170-32**
- 330 x 40 mm **078-170-40**
- 330 x 50 mm **078-170-50**

**RIBBON**



biegsam  
 malleable  
 maleable  
 malleabile

- 280 x 25/30 mm **078-200-01**
- 300 x 37/45 mm **078-200-02**
- 300 x 40/50 mm **078-200-03**

**RIBBON**

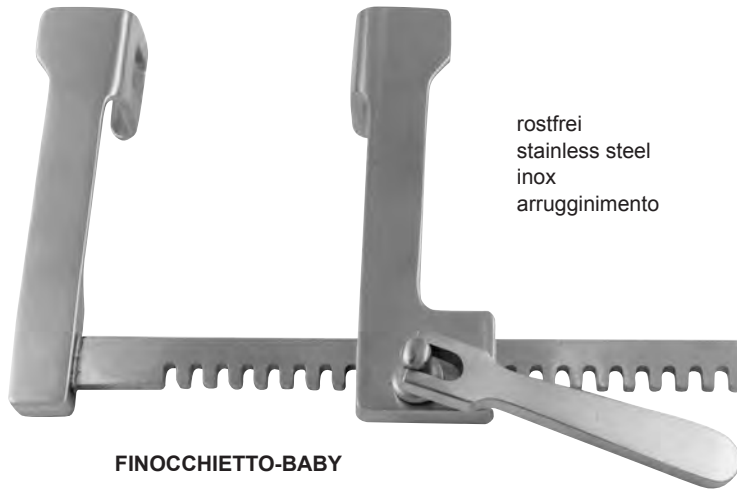


biegsam  
 malleable  
 maleable  
 malleabile

**TUFFIER**  
 200 x 25/17 mm  
**078-220-20**



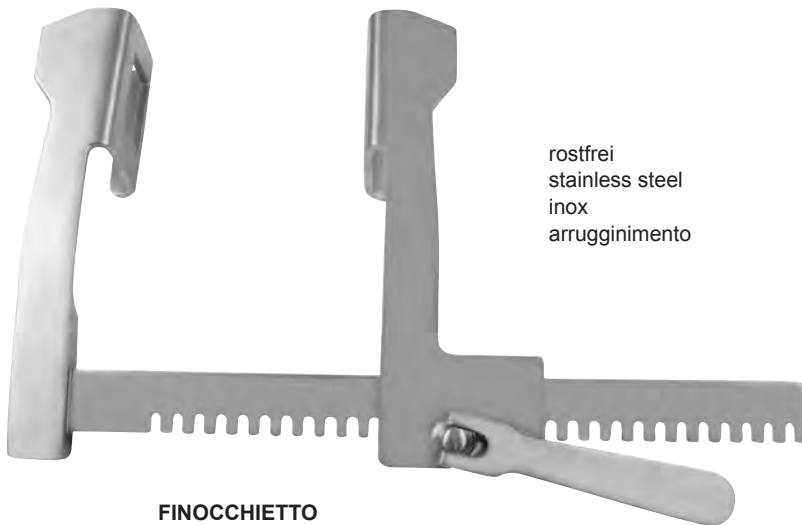
**REVERDIN**  
 280 x 45/60 mm  
**078-230-28**



rostfrei  
stainless steel  
inox  
arrugginimento

**FINOCCHIETTO-BABY**

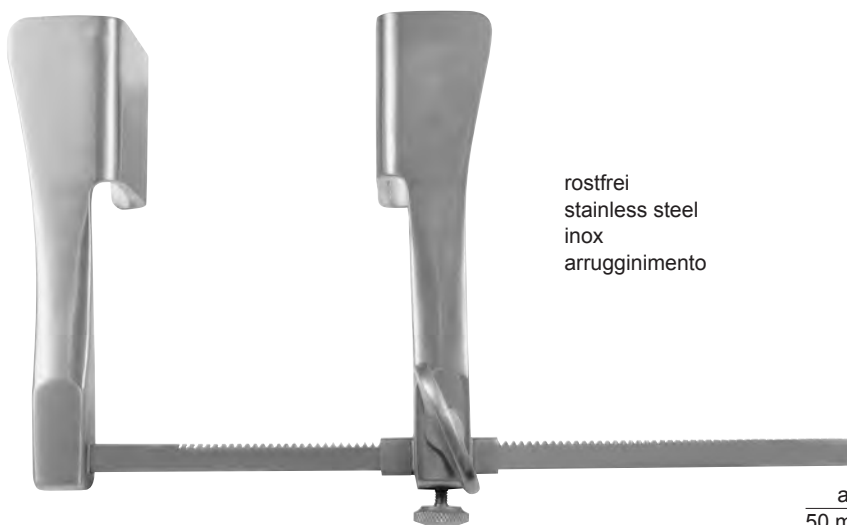
a	b	c	
18 mm	20 mm	75 mm	<b>140-100-01</b>



rostfrei  
stainless steel  
inox  
arrugginimento

**FINOCCHIETTO**

a	b	c	
40 mm	40 mm	165 mm	<b>140-100-02</b>
45 mm	65 mm	200 mm	<b>140-100-03</b>
70 mm	65 mm	250 mm	<b>140-100-04</b>



rostfrei  
stainless steel  
inox  
arrugginimento

**TUFFIER**

a	b	c	
50 mm	45 mm	165 mm	<b>140-150-01</b>



**Sonden, Trokare**  
**Probes, Trocars**  
**Sondas, Trócares**  
**Sonde, Trequarti**

Sonden  
Probes  
Sondas  
Sonde



	Ø 1,0 mm	Ø 2,0 mm
11,5 cm, 4 1/2"	<b>080-000-11</b>	<b>080-004-11</b>
13,0 cm, 5"	<b>080-000-13</b>	<b>080-004-13</b>
14,5 cm, 5 3/4"	<b>080-000-14</b>	<b>080-004-14</b>
16,0 cm, 6 1/4"	<b>080-000-16</b>	<b>080-004-15</b>
18,0 cm, 7"	<b>080-000-18</b>	<b>080-004-18</b>
20,0 cm, 8"	<b>080-000-20</b>	<b>080-004-20</b>

Ø 2,0 mm



11,5 cm, 4 1/2"	<b>080-013-11</b>
13,0 cm, 5"	<b>080-013-13</b>
14,5 cm, 5 3/4"	<b>080-013-14</b>
16,0 cm, 6 1/4"	<b>080-013-16</b>
18,0 cm, 7"	<b>080-013-18</b>
20,0 cm, 8"	<b>080-013-20</b>

Ø 1,0 mm



Silber  
Silver  
Plata  
Argento

**STACKE**  
10,5 cm, 4 1/8"  
**080-033-10**



Myrtenblattsonden  
Myrtle leaf probes  
Sondas para mirto  
Sonde a foglia di mirto

11,5 cm, 4 1/2"	<b>080-027-11</b>
13,0 cm, 5"	<b>080-027-13</b>
14,5 cm, 5 3/4"	<b>080-027-14</b>
16,0 cm, 6 1/4"	<b>080-027-16</b>
18,0 cm, 7"	<b>080-027-18</b>
20,0 cm, 8"	<b>080-027-20</b>



**NÉLATON**  
16,0 cm, 6 1/4"  
**080-120-16**



**DOYEN**  
14,5 cm, 5 3/4"  
**080-117-14**

Ø 3,5 mm



**BRODIE**  
20,0 cm, 8"  
**080-126-20**



Ø 3,5 mm

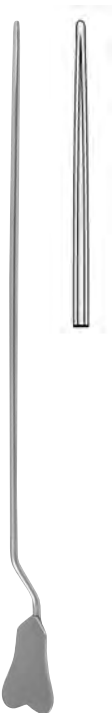


- 11,5 cm, 4 1/2" **080-110-11**
- 13,0 cm, 5" **080-110-13**
- 14,5 cm, 5 3/4" **080-110-14**
- 16,0 cm, 6 1/4" **080-110-16**
- 18,0 cm, 7" **080-110-18**
- 20,0 cm, 8" **080-110-20**

Ø 3,3 mm



- 13,0 cm, 5" **080-122-13**
- 14,5 cm, 5 3/4" **080-122-14**
- 16,0 cm, 6 1/4" **080-122-16**
- 18,0 cm, 7" **080-122-18**



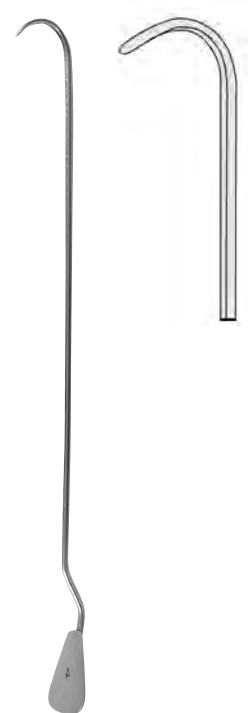
**LOCKHART-MUMMERY**  
 16,5 cm, 6 1/2"  
**080-130-01**



**LOCKHART-MUMMERY**  
 16,5 cm, 6 1/2"  
**080-130-02**

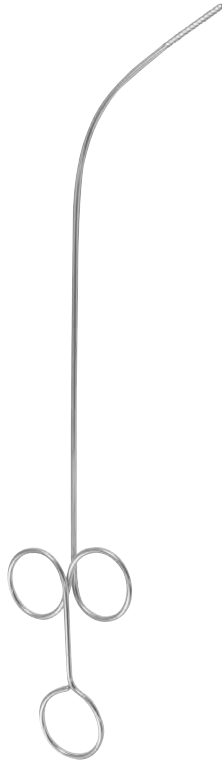


**LOCKHART-MUMMERY**  
 16,5 cm, 6 1/2"  
**080-130-03**



**LOCKHART-MUMMERY**  
 16,5 cm, 6 1/2"  
**080-130-04**

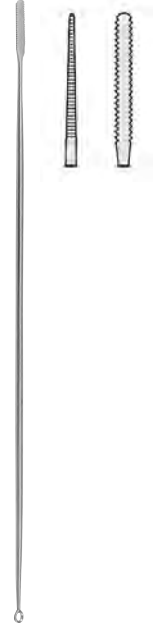
Watteträger  
Cotton Applicators  
Porta-algodones  
Porta-cotone



**FEIN**  
28,0 cm, 11"  
080-264-28



**UKERMANN**  
16,0 cm, 6 1/4"  
080-260-16



**JOBSON-HORNE**  
18,0 cm, 7"  
080-262-18



12,0 cm, 4 3/4"	<b>080-271-12</b>	Ø 0,9 mm
14,0 cm, 5 3/4"	<b>080-271-14</b>	Ø 0,9 mm
16,5 cm, 6 1/4"	<b>080-271-16</b>	Ø 1,1 mm
18,0 cm, 7"	<b>080-271-18</b>	Ø 1,2 mm

**FARRELL  
(LATHBURY)**



12,0 cm, 4 3/4"	<b>080-270-12</b>	Ø 0,9 mm
14,0 cm, 5 3/4"	<b>080-270-14</b>	Ø 0,9 mm
16,5 cm, 6 1/4"	<b>080-270-16</b>	Ø 1,1 mm
18,0 cm, 7"	<b>080-270-18</b>	Ø 1,2 mm

**FARRELL**



**080-150-01**  
Metalletui  
Metal case  
Estuche de metal  
Scatola in metallo  
135 x 100 x 25 mm



Ø 3,0 mm  
**080-150-03**



Ø 6,0 mm  
**080-150-06**

**NABATOFF**  
**080-150-00**  
komplett  
complete  
completo  
completo



Ø 9,0 mm  
**080-150-09**

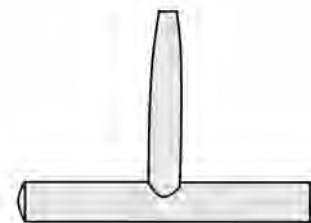


**080-150-21**  
Zugseil  
Cable  
Cable  
Fune



Ø 12,0 mm  
**080-150-12**

**080-150-22**  
Kunststoff-Sondenspitze  
Plastic probe tip  
Extremidad de sonda de plástico  
Punta in materia plastica



**080-150-20**  
Handgriff  
Handle  
Mango  
Manico



Ø 3,0 mm	<b>084-110-30</b>
Ø 3,5 mm	<b>084-110-35</b>
Ø 4,0 mm	<b>084-110-40</b>
Ø 4,5 mm	<b>084-110-45</b>
Ø 5,0 mm	<b>084-110-50</b>
Ø 5,5 mm	<b>084-110-55</b>
Ø 6,0 mm	<b>084-110-60</b>

**STANDARD**  
11,0 cm, 4<sup>3</sup>/<sub>8</sub>"



Ø 3,0 mm	<b>084-112-30</b>
Ø 3,5 mm	<b>084-112-35</b>
Ø 4,0 mm	<b>084-112-40</b>
Ø 4,5 mm	<b>084-112-45</b>
Ø 5,0 mm	<b>084-112-50</b>
Ø 5,5 mm	<b>084-112-55</b>
Ø 6,0 mm	<b>084-112-60</b>

**STANDARD**  
12,0 cm, 4<sup>3</sup>/<sub>4</sub>"



Ø 3,0 mm	<b>084-114-30</b>
Ø 3,5 mm	<b>084-114-35</b>
Ø 4,0 mm	<b>084-114-40</b>
Ø 4,5 mm	<b>084-114-45</b>
Ø 5,0 mm	<b>084-114-50</b>
Ø 5,5 mm	<b>084-114-55</b>
Ø 6,0 mm	<b>084-114-60</b>

**STANDARD**  
12,0 cm, 4<sup>3</sup>/<sub>4</sub>"

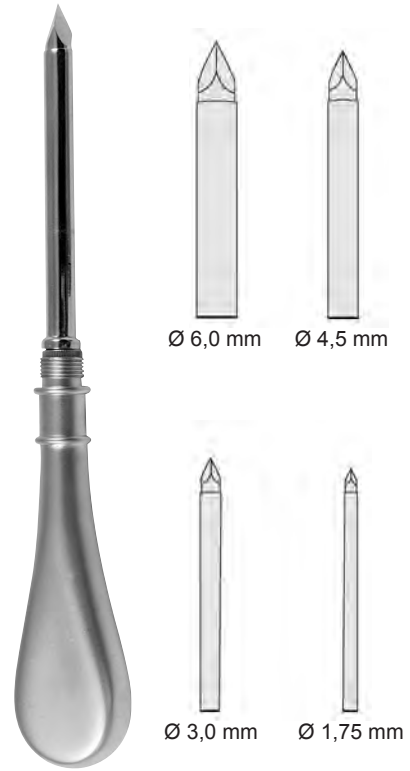


Ø 7,3 mm	<b>084-118-07</b>
Ø 8,7 mm	<b>084-118-09</b>
Ø 12,0 mm	<b>084-118-12</b>

**HURWITZ**



**UNIVERSAL**  
084-100-03



**UNIVERSAL**  
084-100-04

140 mm

**LANDAU**  
Ø 2,0 mm  
084-160-16

**LANDAU**  
Ø 2,0 mm  
084-161-16

**DAVIDSON**  
Ø 6,0 mm  
084-164-18

**BUELAU**  
Ø 8,0 mm  
084-124-24

Trokare  
Trocars  
Trócares  
Trequarti



Ø 6,0 mm    **084-128-06**  
Ø 8,0 mm    **084-128-08**

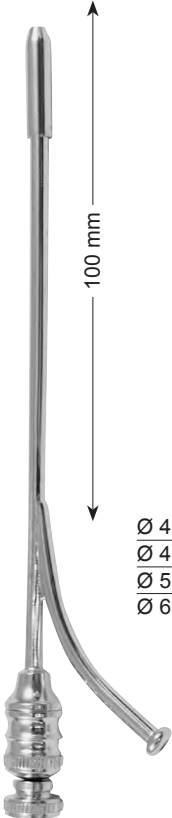
**CAMPBELL**  
16,0 cm, 6 1/4"



80 mm

Ø 7,5 mm    **084-120-01**  
Ø 9,0 mm    **084-120-02**  
Ø 10,5 mm   **084-120-03**  
Ø 12,0 mm   **084-120-04**

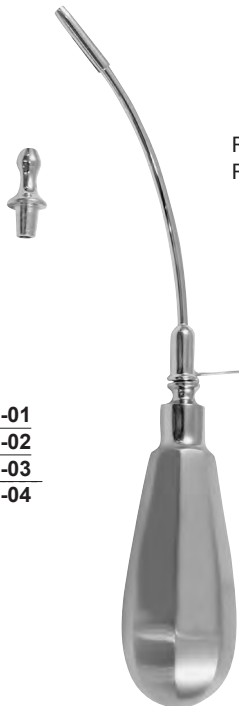
**NELSON**  
21,0 cm, 8 1/2"



100 mm

Ø 4,0 mm    **084-140-01**  
Ø 4,6 mm    **084-140-02**  
Ø 5,5 mm    **084-140-03**  
Ø 6,5 mm    **084-140-04**

**OCHSNER**  
14,0 cm, 5 1/2"



Record Konus  
Record cone

Ø 3,0 mm    **084-180-30**  
Ø 4,0 mm    **084-180-40**  
Ø 5,0 mm    **084-180-50**

**PIERCE**  
16,0 cm, 6 1/4"



Ø 2,25 mm

**COAKLEY**  
14,0 cm, 5 1/4"  
**084-190-14**





**IZIAL DENTAL SURGICAL**

Manufacturer And Exporter Of Surgical Dental & Manicure

**Trokare, Saugrohre  
Trocars, Suction Tubes  
Trócares, Tubos para aspiración  
Trequarti, Tubi aspirazione**

Ø 4,0 mm



**KRAUSE**  
16,0 cm, 6 1/4"

**LICHTWITZ**

Kieferhöhlentrokare  
Antrum trocars  
Trócares para el seno maxilar  
Trequarti per puntura del seno mascellare

Ø 3,0 mm    **084-184-30**  
Ø 4,0 mm    **084-184-40**  
Ø 5,0 mm    **084-184-50**  
Ø 5,5 mm    **084-184-55**

Ø 1,8 mm



**LICHTWITZ**  
20,0 cm, 8"  
**084-170-00**



**LICHTWITZ**  
11,0 cm, 4 1/2"  
**084-172-00**



**DOUGLAS**  
Ø 3,0 mm  
**084-175-00**



**POOLE**  
22,0 cm, 8 5/8"  
Ø 6,0 mm    **085-020-06**  
Ø 10,0 mm   **085-020-10**



**POOLE**  
22,0 cm, 8 5/8"  
Ø 6,0 mm    **085-021-06**  
Ø 8,0 mm    **085-021-08**

**Saugrohre**  
**Suction Tubes**  
**Tubos para aspiración**  
**Tubi aspirazione**

auswechselbare Spitze  
 interchangeable tip  
 punta intercambiabile  
 tipo intercambiabile



Ø 3,5 mm  
**085-010-35**



**085-024-00**  
 Olive allein  
 Olive only  
 Oliva suelto  
 Olivo solo



**COUPLAND**  
 17,0 cm, 6<sup>3</sup>/<sub>4</sub>"  
**085-010-17**



**YANKAUER**  
 27,0 cm, 10<sup>5</sup>/<sub>8</sub>"  
**085-000-27**



**DE BAKEY**  
 27,0 cm, 10<sup>5</sup>/<sub>8</sub>"  
**085-008-27**



**ANTHONY**  
 26,0 cm, 10<sup>1</sup>/<sub>4</sub>"  
**085-007-26**



**ANDREWS-PYNCHON**  
 24,0 cm, 9<sup>1</sup>/<sub>2</sub>"  
**085-006-24**



**COOLEY**  
 35,0 cm, 13<sup>3</sup>/<sub>4</sub>"  
 Ø 8,0 mm  
**085-024-02**



**COOLEY**  
 30,0 cm, 11<sup>3</sup>/<sub>4</sub>"  
 Ø 7,0 mm  
**085-024-03**



**COOLEY**  
 31,0 cm, 11<sup>3</sup>/<sub>4</sub>"  
 Ø 10,0 mm  
**085-024-04**



**COOLEY**  
 33,0 cm, 13"  
 Ø 8,0 mm  
**085-024-01**



**BYRD**  
20,0 cm, 8"  
Ø 1,5 mm    **085-012-15**  
Ø 2,5 mm    **085-012-25**  
Ø 3,5 mm    **085-012-35**

Ø 4,0 mm



**ADSON**  
21,0 cm, 8 1/4"  
**085-050-21**



**MAGILL**  
17,5 cm, 6 5/8"  
Ø 1,0 mm    **085-060-01**  
Ø 2,0 mm    **085-060-02**  
Ø 3,0 mm    **085-060-03**  
Ø 4,0 mm    **085-060-04**



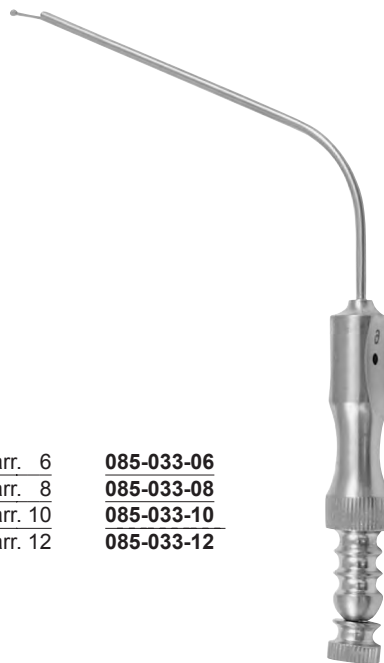
**FRAZIER**  
19,0 cm, 7 1/2"

Charr. 6    **085-030-06**  
Charr. 8    **085-030-08**  
Charr. 10    **085-030-10**  
Charr. 12    **085-030-12**



**FERGUSON**  
18,0 cm, 7"

Charr. 6    **085-033-06**  
Charr. 8    **085-033-08**  
Charr. 10    **085-033-10**  
Charr. 12    **085-033-12**



**POPPEN**  
13,0 cm, 5"

Charr. 6    **085-034-06**  
Charr. 8    **085-034-08**  
Charr. 10    **085-034-10**  
Charr. 12    **085-034-12**

Spezialkanülen  
Special Needles  
Agujas especiales  
Aghi speciali



Packung zu 12 Stück  
Package of 12 pcs.  
Cajecita de 12 pzs.  
Confezione da 12 pezzi

Ø 0,90 x 38 mm	<b>086-000-01</b>
Ø 0,80 x 32 mm	<b>086-000-02</b>
Ø 0,70 x 32 mm	<b>086-000-03</b>
Ø 0,65 x 28 mm	<b>086-000-04</b>
Ø 0,60 x 25 mm	<b>086-000-05</b>
Ø 0,50 x 23 mm	<b>086-000-06</b>
Ø 0,45 x 20 mm	<b>086-000-07</b>

**LUER-LOCK**



**IOWA**  
14,0 cm, 5 1/4"  
**086-150-14**

Ø 1,0 x 185 mm

**086-150-01**  
Nadel  
Needle  
Aguja  
Aghi



**MOCK**  
6,0 cm, 2 3/8"  
**086-200-06**



**SCHMID**  
15,0 cm, 6"



Ø 3,0 mm  
**086-140-03**



Ø 4,0 mm  
**086-140-04**



Ø 5,0 mm  
**086-140-05**



Ø 6,0 mm  
**086-140-06**

Gefäßspülkanülen, biegsam  
Vascular irrigation cannulae, malleable  
Cánulas vasculares para irrigación, maleables  
Aghi vascolari per irrigazione, malleabili



Ø 1,20 x 80 mm **086-210-12**  
Ø 1,50 x 80 mm **086-210-15**



Ø 2,00 x 100 mm **086-180-10**  
Ø 2,00 x 120 mm **086-180-12**  
Ø 2,00 x 150 mm **086-180-15**

**VERESS**

Kanülen zur Sternalpunktion  
Sternum puncture needles  
Agujas para la punción del esternón  
Aghi per puntura dello sterno



**KLIMA-ROSSEGGER**  
Ø 1,60 x 40 mm  
**086-060-16**

Kanülen zur Lumbalpunktion  
Lumbar puncture needles  
Agujas para punción lumbar  
Aghi per punture lombari



Ø 0,8 x 70/80/90/100/120 mm **086-130-01**  
Ø 1,0 x 70/80/90/100/120 mm **086-130-02**  
Ø 1,2 x 70/80/90/100/120 mm **086-130-03**  
Ø 1,4 x 70/80/90/100/120 mm **086-130-04**  
Ø 1,6 x 70/80/90/100/120 mm **086-130-05**  
Ø 1,8 x 70/80/90/100/120 mm **086-130-06**  
Ø 2,0 x 70/80/90/100/120 mm **086-130-07**

**BIER**

**Spezialkanülen**  
**Special Needles**  
**Agujas especiales**  
**Aghi speciali**

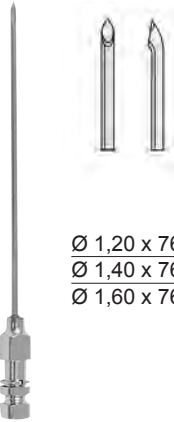
Kanülen zur Lumbalpunktion  
 Lumbar puncture needles  
 Aguja para punción lumbar  
 Aghi per punture lombari



**QUINKE**

- Ø 1,20 x 76 mm **086-120-01**
- Ø 1,20 x 89 mm **086-120-02**
- Ø 1,00 x 76 mm **086-120-03**
- Ø 1,00 x 89 mm **086-120-04**
- Ø 0,70 x 76 mm **086-120-05**
- Ø 0,70 x 50 mm **086-120-06**
- Ø 0,70 x 89 mm **086-120-07**

Kanülen zur Lumbalpunktion  
 Lumbar puncture needles  
 Aguja para punción lumbar  
 Aghi per punture lombari



**TUHOJ**

- Ø 1,20 x 76 mm **086-090-12**
- Ø 1,40 x 76 mm **086-090-14**
- Ø 1,60 x 76 mm **086-090-16**

Kanülen zur Leberblindpunktion  
 Liver blind puncture needles  
 Aguja para punción ciega del hígado  
 Aghi per punture cieca del fegato



**MENGHINI**

- Ø 1,00 x 35 mm **086-115-01**
- Ø 1,00 x 70 mm **086-115-02**
- Ø 1,20 x 70 mm **086-115-03**
- Ø 1,20 x 100 mm **086-115-04**
- Ø 1,40 x 70 mm **086-115-05**
- Ø 1,40 x 100 mm **086-115-06**
- Ø 1,60 x 70 mm **086-115-07**
- Ø 1,60 x 100 mm **086-115-08**

Kanülen zur gezielten Leberpunktion  
 Needles for controlled liver puncture  
 Aguja para la punción del hígado bajo el control laparoscópico  
 Aghi per la punture controllata del fegato



**MENGHINI**

- Ø 1,40 x 168 mm **086-117-14**
- Ø 1,80 x 168 mm **086-117-18**

Trokare für Kanülen  
 Trocars for needles  
 Trocares para agujas  
 Trequarti oer aghi



- Ø 1,40 x 168 mm **086-230-14**
- Ø 1,80 x 168 mm **086-230-18**



**IZIAL DENTAL SURGICAL**  
 Manufacturer And Exporter Of Surgical Dental & Manicure

Spritzen, Ersatzzylinder  
 Syringes, Spare barrel  
 Jeringas, Cilindro de requesto  
 Siringhe, Cilindro di ricambio



1 ml **087-051-01**  
 2 ml **087-051-02**  
 5 ml **087-051-05**  
 10 ml **087-051-10**  
 20 ml **087-051-20**  
 50 ml **087-051-50**



1 ml **087-001-01**  
 2 ml **087-001-02**  
 5 ml **087-001-05**  
 10 ml **087-001-10**  
 20 ml **087-001-20**  
 50 ml **087-001-50**



1 ml **087-061-01**  
 2 ml **087-061-02**



**LUER**

1 ml **087-050-01**  
 2 ml **087-050-02**  
 5 ml **087-050-05**  
 10 ml **087-050-10**  
 20 ml **087-050-20**  
 50 ml **087-050-50**



**LUER-LOCK**

1 ml **087-000-01**  
 2 ml **087-000-02**  
 5 ml **087-000-05**  
 10 ml **087-000-10**  
 20 ml **087-000-20**  
 50 ml **087-000-50**



**LUER-LOCK**

2 ml **087-055-02**  
 5 ml **087-055-05**  
 10 ml **087-055-10**

**INSULIN LUER**



1 ml **087-060-01**  
 2 ml **087-060-02**

Spritzen  
Syringes  
Jeringas  
Siringhe



50 ml **087-071-05**  
 100 ml **087-071-10**  
 150 ml **087-071-15**  
 200 ml **087-071-20**



10 ml **087-081-10**  
 20 ml **087-081-20**  
 30 ml **087-081-30**  
 50 ml **087-081-50**



**JANET**

50 ml **087-070-05**  
 100 ml **087-070-10**  
 150 ml **087-070-15**  
 200 ml **087-070-20**





Zwischenstück, LUER-LOCK weiblich  
Connecting piece, LUER-LOCK female  
Pieza de conexión, LUER-LOCK hembra  
Raccordo, LUER-LOCK femmina



**087-911-00**

Zwischenstück, LUER-LOCK männlich  
Connecting piece, LUER-LOCK male  
Pieza de conexión, LUER-LOCK masculino  
Raccordo, LUER-LOCK maschio



**087-930-02**

Zwischenstück, LUER-LOCK männlich  
Connecting piece, LUER-LOCK male  
Pieza de conexión, LUER-LOCK masculino  
Raccordo, LUER-LOCK maschio

Ø 6 mm

Ø 8 mm



**087-912-06**



**087-912-08**

Zwischenstück, LUER-LOCK weiblich  
Connecting piece, LUER-LOCK female  
Pieza de conexión, LUER-LOCK hembra  
Raccordo, LUER-LOCK femmina



**087-913-00**

Zwischenstück, LUER-LOCK männlich  
Connecting piece, LUER-LOCK male  
Pieza de conexión, LUER-LOCK masculino  
Raccordo, LUER-LOCK maschio



**087-935-00**

Durchflußhahn, LL männl. – LL weibl.  
Stopcock, LL male – LL female  
Llave, LL masculino – LL hembra  
Rubinetto, LL maschio – LL femmina



**087-939-00**

Durchflußhahn, LL weiblich  
Stopcock, LL female  
Llave, LL hembra  
Rubinetto, LL femmina



**087-920-00**

Dreiweghahn, 1 LL männl. – 2 LL weibl.  
Three-way-stopcock, 1 LL male – 2 LL female  
Llave de 3 vías, 1 LL masculino – 2 LL hembra  
Rubinetto a tre vie, 1 LL maschio – 2 LL femmina



**087-922-00**

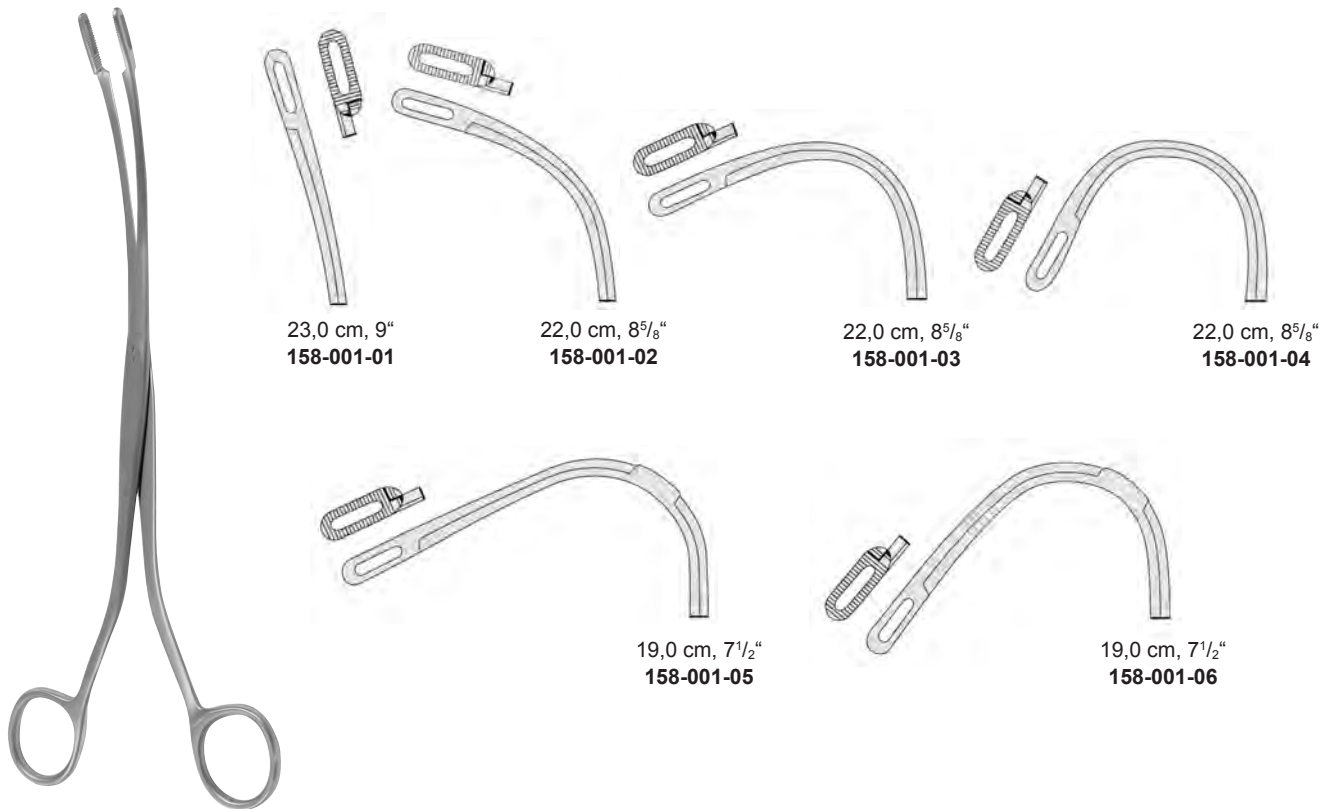
Dreiweghahn, 3 LL weiblich  
Three-way-stopcock, 3 LL female  
Llave de 3 vías, 3 LL hembra  
Rubinetto a tre vie, 3 LL femmina



**087-926-00**

**Galle, Leber, Niere, Blase, Urologie**  
**Gall, Liver, Kidney, Bladder, Urology**  
**Bilis, Hígado, Riñon, Vejiga, Urología**  
**Bile, Fegato, Rene, Vescica, Urologia**

Nierensteinzangen, Gallensteinzangen  
 Kidney Stone Forceps, Gall Stone Forceps  
 Pinzas para los cálculos renales, Pinzas para los cálculos biliars  
 Pinze per calcoli renali, Pinze per calcoli biliari



**RANDALL**

23,0 cm, 9"  
 158-001-01

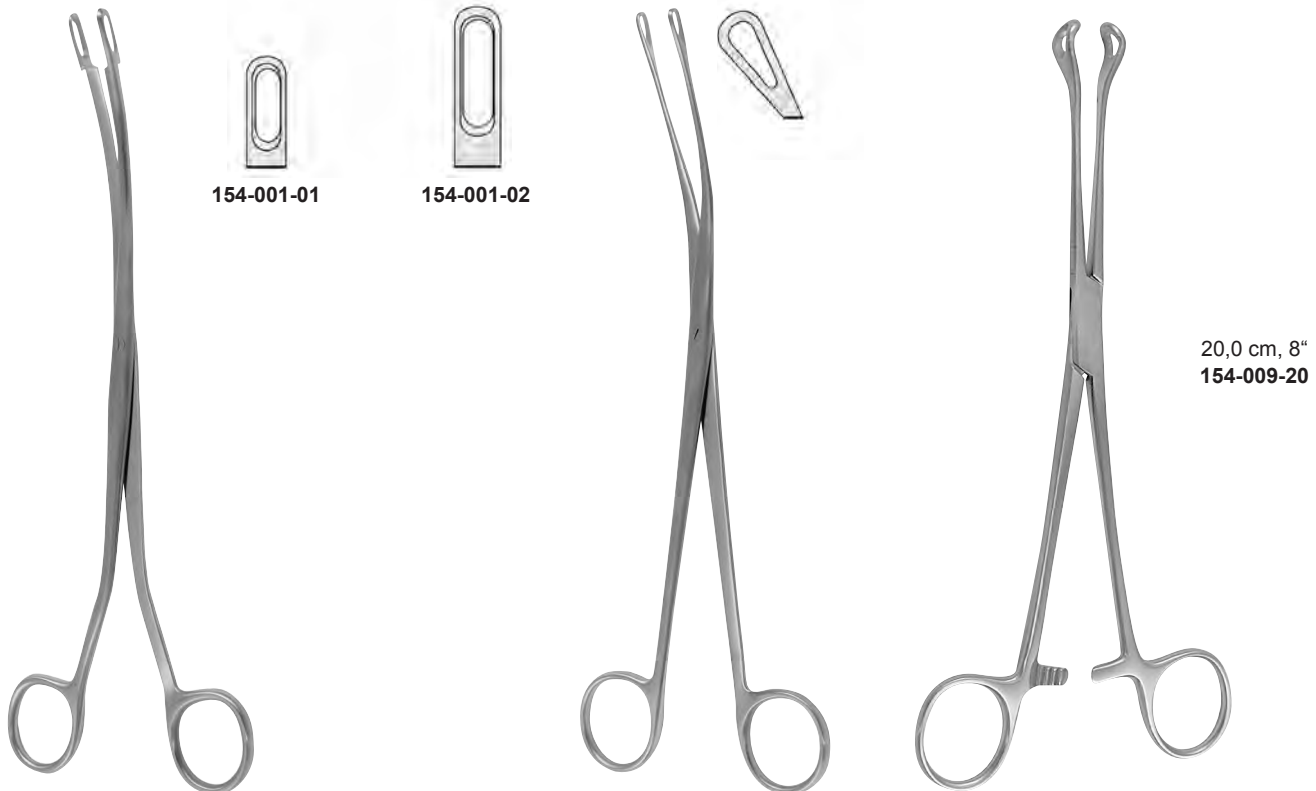
22,0 cm, 8<sup>5</sup>/<sub>8</sub>"  
 158-001-02

22,0 cm, 8<sup>5</sup>/<sub>8</sub>"  
 158-001-03

22,0 cm, 8<sup>5</sup>/<sub>8</sub>"  
 158-001-04

19,0 cm, 7<sup>1</sup>/<sub>2</sub>"  
 158-001-05

19,0 cm, 7<sup>1</sup>/<sub>2</sub>"  
 158-001-06



154-001-01

154-001-02

20,0 cm, 8"  
 154-009-20

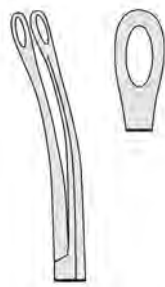
**DESJARDINS**  
 23,0 cm, 9"

**MIXTER**  
 22,0 cm, 8<sup>5</sup>/<sub>8</sub>"  
 154-021-22

**MAYO BLAKE**  
 20,0 cm, 8"  
 154-008-20



**BLAKE**  
20,0 cm, 8"  
154-006-20



20,0 cm, 8"  
154-005-20



**TURNER-WARWICK**  
18,0 cm, 7"

154-031-01

154-031-03

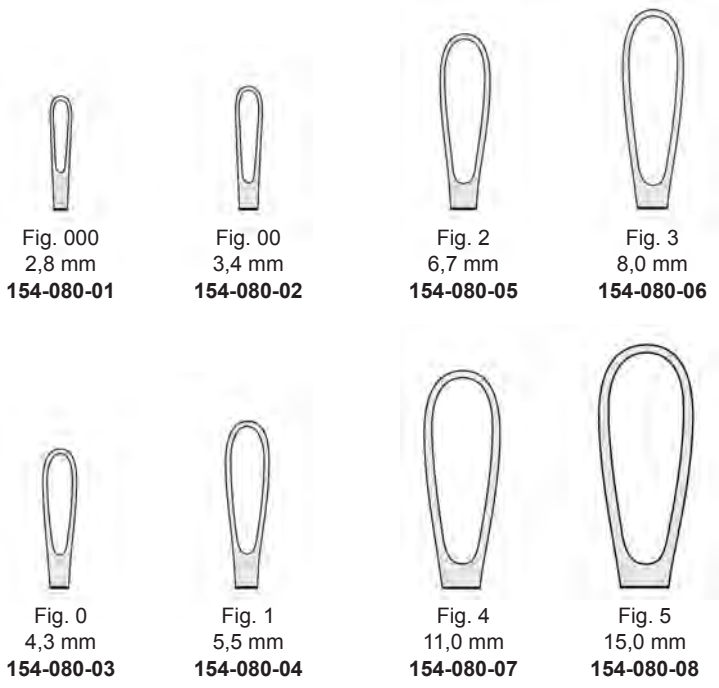


**CZERNY**  
24,5 cm, 9<sup>5</sup>/<sub>8</sub>"  
154-039-24

Gallensteinlöffel  
 Gall Stone Scoops  
 Cucharillas para los cálculos biliares  
 Cucchiari per calcoli biliari



**LUER-KÖRTE**  
 24,0 cm, 9½"



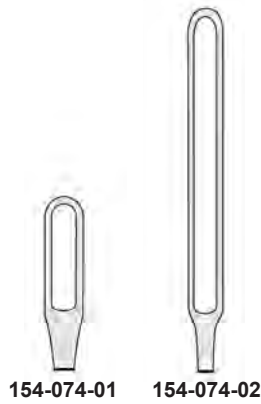
**FERGUSON**  
 21,5 cm, 8½"  
 154-070-01



**MAYO**  
 27,0 cm, 10⅝"  
 154-072-01



**MAYO**  
 27,0 cm, 10⅝"



**MOYNIHAN**  
 34,0 cm, 13⅜"  
 154-076-34



**Gallengangsonden, Gallengang Dilatatore  
Gall Duct Probes, Common Bile Duct Dilators  
Sonas p. el conducto biliar, Dilatadores para el conducto biliar  
Dilatatori per condotti biliari, Dilatatori per coledoco**



**MAYO**  
32,0 cm, 12<sup>1</sup>/<sub>2</sub>"  
154-078-32



**OCHSNER**  
35,0 cm, 13<sup>3</sup>/<sub>4</sub>"  
154-082-35



**DESJARDINS**  
28,0 cm, 11"



**MOORE**  
30,0 cm, 12"  
154-084-30

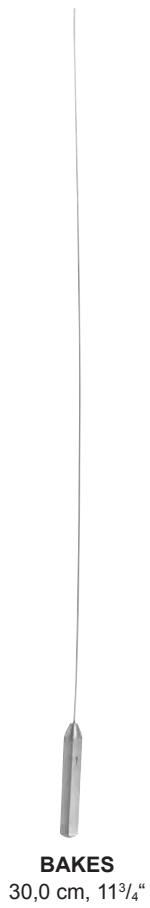
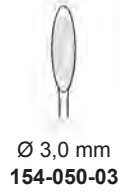
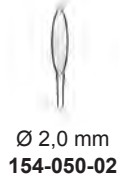
Gallenblasenlöffel  
Gall bladder scoope  
Cucharilla para la vesicula biliar  
Cucchiaio per colecisti

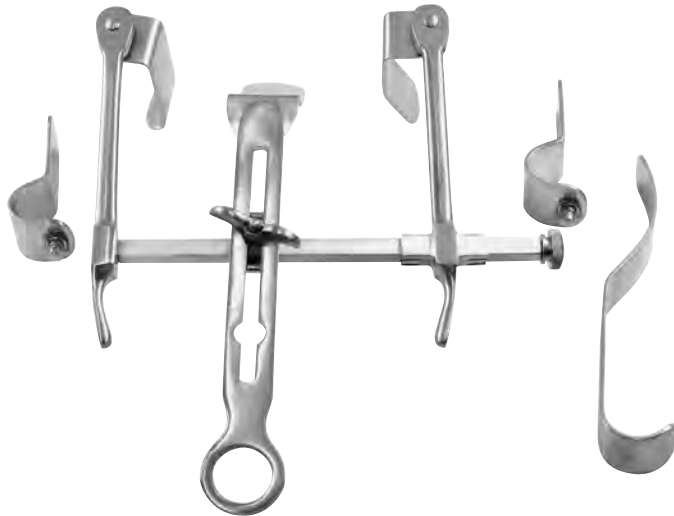


**DESJARDINS**  
28,0 cm, 11"

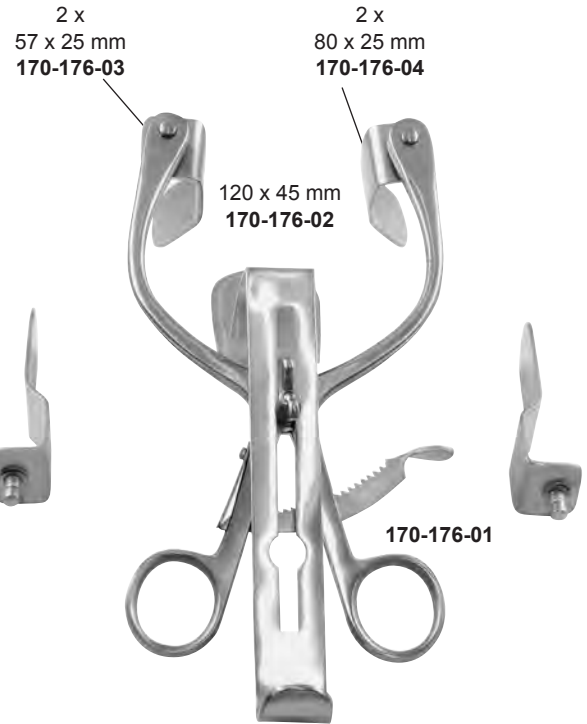


Gallengang Dilatatoren  
Common Bile Duct Dilators  
Dilatadores para el conducto biliar  
Dilatatori per coledoco

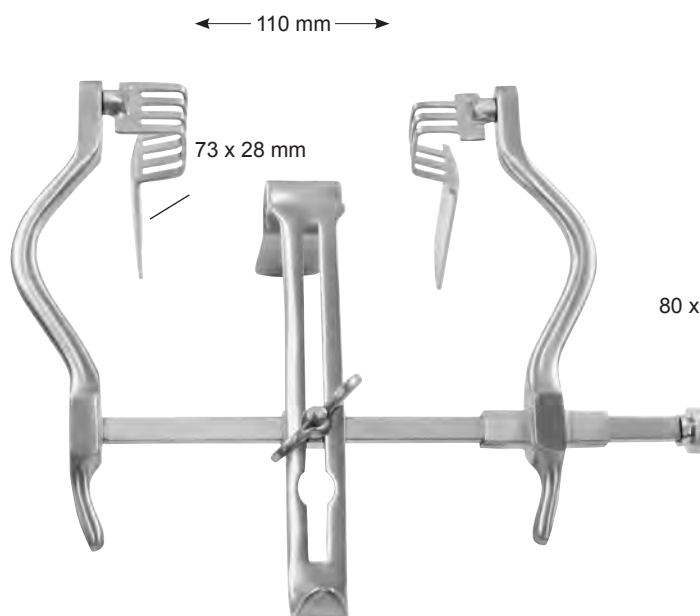




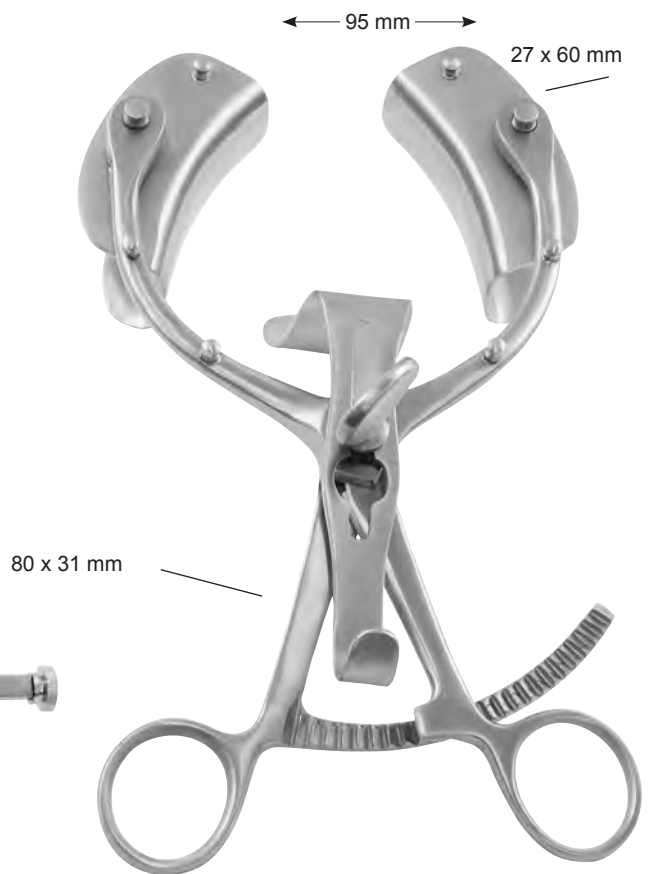
**THOMSON-WALKER**  
170-182-00



**MILLIN**  
170-176-00



**JUDD-MASSON**  
170-172-00



**LEGUEU**  
170-160-00





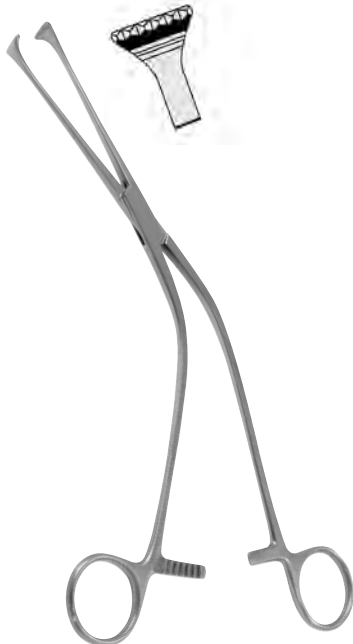
**MILLIN**  
 23,0 cm, 9"  
 170-073-23



**MILLIN**  
 24,0 cm, 9½"  
 170-071-24



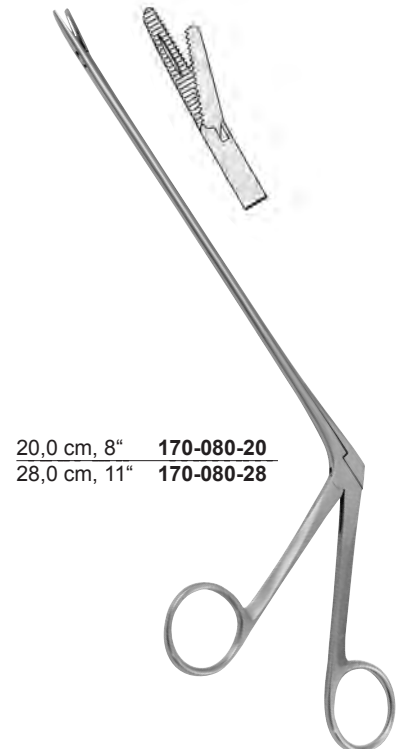
**MILLIN**  
 24,0 cm, 9½"  
 170-077-24



**MILLIN**  
 23,0 cm, 9"  
 170-075-23



**MILLIN**  
 28,5 cm, 11¼"  
 170-150-24



20,0 cm, 8" **170-080-20**  
 28,0 cm, 11" **170-080-28**

**MATHIEU**



**YOUNG**  
21,0 cm, 8<sup>1</sup>/<sub>4</sub>"  
170-230-21



**YOUNG**  
22,0 cm, 8<sup>5</sup>/<sub>8</sub>"  
170-236-22



**YOUNG**  
21,0 cm, 8<sup>1</sup>/<sub>4</sub>"  
170-238-21



**YOUNG**  
22,0 cm, 8<sup>5</sup>/<sub>8</sub>"  
170-240-22



90 x 35 mm

**LEGUEU**  
26,0 cm, 10<sup>1</sup>/<sub>4</sub>"  
170-250-26



90 x 61 mm

**KOCHER**  
23,5 cm, 9<sup>1</sup>/<sub>4</sub>"  
170-257-23

**Katheter, Penisklemmen**  
**Catheters, Penis Clamp**  
**Sondas, Compresor urétral**  
**Cateteri, Serrapene**



für Männer  
 for men  
 para hombres  
 per uomini

Char. 8	<b>170-650-08</b>
Char. 10	<b>170-650-10</b>
Char. 12	<b>170-650-12</b>
Char. 14	<b>170-650-14</b>
Char. 16	<b>170-650-16</b>
Char. 18	<b>170-650-18</b>
Char. 20	<b>170-650-20</b>
Char. 22	<b>170-650-22</b>
Char. 24	<b>170-650-24</b>

29,0 cm, 11 1/2"



für Frauen  
 for women  
 para mujeres  
 per donne

Char. 6	<b>170-660-06</b>
Char. 7	<b>170-660-07</b>
Char. 8	<b>170-660-08</b>
Char. 9	<b>170-660-09</b>
Char. 10	<b>170-660-10</b>
Char. 11	<b>170-660-11</b>
Char. 12	<b>170-660-12</b>
Char. 13	<b>170-660-14</b>
Char. 15	<b>170-660-15</b>
Char. 16	<b>170-660-16</b>
Char. 18	<b>170-660-18</b>
Char. 20	<b>170-660-20</b>
Char. 24	<b>170-660-24</b>

16,0 cm, 6 1/4"



**STRAUSS**  
 11,0 cm, 4 1/3"  
**170-349-11**



**STOCKMANN**  
 8,0 cm, 3 1/4"  
**170-345-08**

Ø 8,0 mm	<b>170-350-08</b>
Ø 11,0 mm	<b>170-350-11</b>
Ø 13,0 mm	<b>170-350-13</b>
Ø 16,0 mm	<b>170-350-16</b>
Ø 21,0 mm	<b>170-350-21</b>
Ø 26,0 mm	<b>170-350-26</b>
Ø 32,0 mm	<b>170-350-32</b>

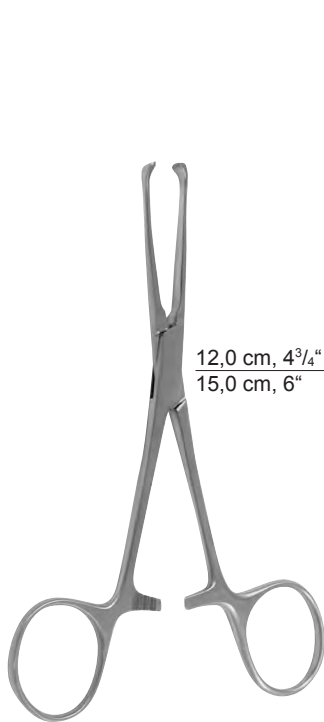


**COMCO**



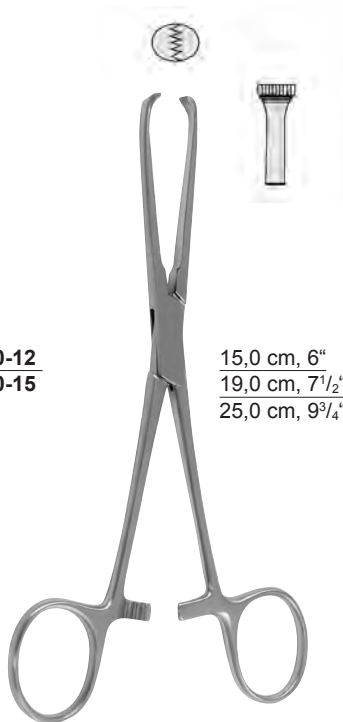
**IZIAL DENTAL SURGICAL**  
Manufacturer And Exporter Of Surgical Dental & Manicure

**Magen, Darm, Mastdarm**  
**Stomach, Intestines, Rectum**  
**Estómago, Intestino, Recto**  
**Stomaco, Intestino, Retto**



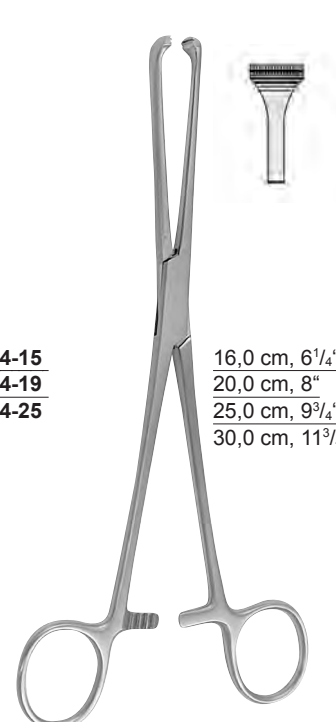
12,0 cm, 4<sup>3</sup>/<sub>4</sub>" **160-000-12**  
 15,0 cm, 6" **160-000-15**

**ALLIS-BABY**



15,0 cm, 6" **160-004-15**  
 19,0 cm, 7<sup>1</sup>/<sub>2</sub>" **160-004-19**  
 25,0 cm, 9<sup>3</sup>/<sub>4</sub>" **160-004-25**

**ALLIS**



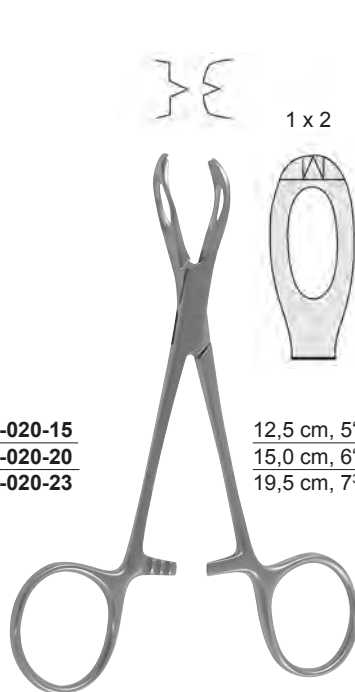
16,0 cm, 6<sup>1</sup>/<sub>4</sub>" **160-124-16**  
 20,0 cm, 8" **160-124-20**  
 25,0 cm, 9<sup>3</sup>/<sub>4</sub>" **160-124-25**  
 30,0 cm, 11<sup>3</sup>/<sub>4</sub>" **160-124-30**

**ALLIS-ATRAUMA**



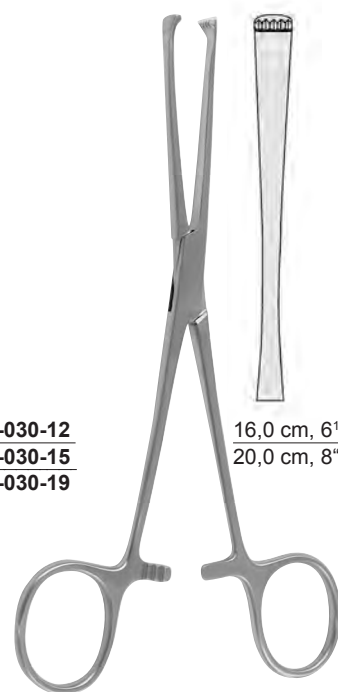
15,5 cm, 6" **160-020-15**  
 20,0 cm, 8" **160-020-20**  
 23,0 cm, 9" **160-020-23**

**ALLEN**



12,5 cm, 5" **160-030-12**  
 15,0 cm, 6" **160-030-15**  
 19,5 cm, 7<sup>3</sup>/<sub>4</sub>" **160-030-19**

**LANE**



16,0 cm, 6<sup>1</sup>/<sub>4</sub>" **160-178-16**  
 20,0 cm, 8" **160-178-20**

**LOCKWOOD-ALLIS**



15,0 cm, 6" **160-040-15**  
19,0 cm, 7 1/2" **160-040-19**

**JUDD-ALLIS**



2 x 3

**LITTLEWOOD**  
18,5 cm, 7 1/4"  
**160-060-16**



10 x 11

**ALLIS-ADAIR**  
15,5 cm, 6"  
**160-010-15**



**BOYS-ALLIS**  
15,5 cm, 6"  
**160-012-15**



6 x 7

**THOMS-ALLIS**  
20,0 cm, 8"  
**160-050-20**



**ALLIS**  
20,0 cm, 8"  
**160-014-20**

Darm- und Gewebefaßzangen  
 Intestinal and Tissue Grasping Forceps  
 Pinzas intestinales y para tejidos  
 Pinze da presa per intestino e tessuti



**LOCKWOOD**  
 20,0 cm, 8"  
 160-169-20



**WILLIAMS**  
 16,0 cm, 6 1/4"  
 160-070-16



16,0 cm, 6 1/4" **160-006-16**  
 18,0 cm, 7" **160-006-18**  
 20,0 cm, 8" **160-006-20**  
 24,0 cm, 9 1/2" **160-006-24**

**BABCOCK**



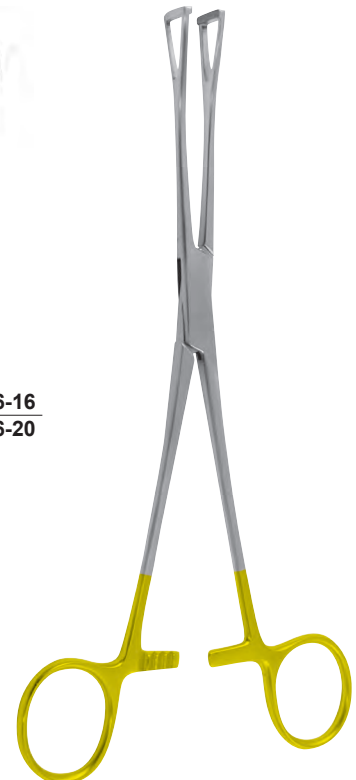
16,0 cm, 6 1/4" **164-006-16**  
 20,0 cm, 8" **164-006-20**

**BABCOCK-ATRAUMA**

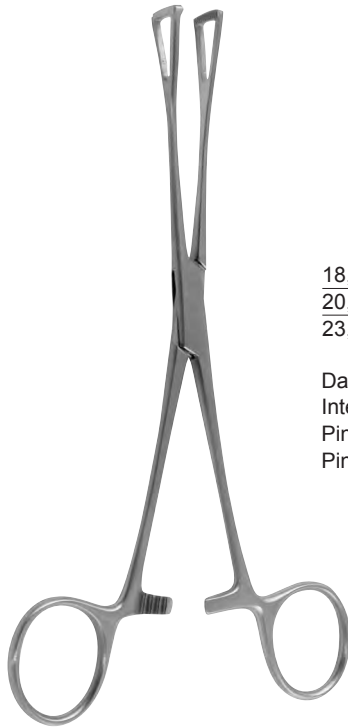


16,0 cm, 6 1/4" **161-006-16**  
 20,0 cm, 8" **161-006-20**

**BABCOCK-T C**



**DUVAL-TC**  
 20,0 cm, 8"  
 161-170-20



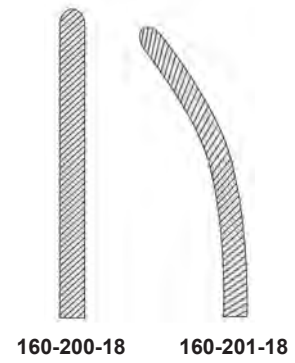
**DUVAL**

18,0 cm, 7"	<b>160-170-18</b>	
20,0 cm, 8"	<b>160-170-20</b>	<b>160-172-20</b>
23,0 cm, 9"		<b>160-172-23</b>

Darm- und Gewebefaßzangen  
Intestinal and Tissue Grasping Forceps  
Pinzas intestinales y para tejidos  
Pinze da presa per intestino e tessuti

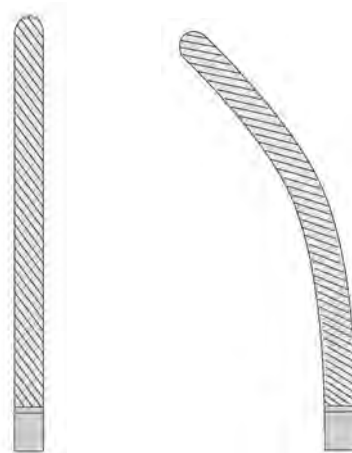


**BABY-DOYEN**  
18,0 cm, 7"



**DOYEN**

21,0 cm, 8 <sup>1</sup> / <sub>4</sub> "	<b>160-210-21</b>	21,0 cm, 8 <sup>1</sup> / <sub>4</sub> "	<b>160-211-21</b>
23,0 cm, 9"	<b>160-210-23</b>	23,0 cm, 9"	<b>160-211-23</b>

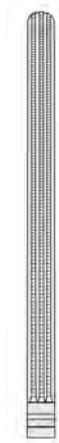




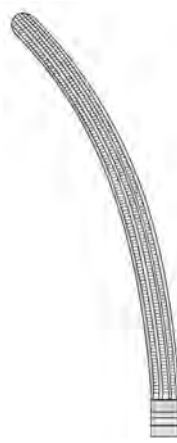
Darmklemmen  
 Intestinal Clamp Forceps  
 Pinzas-clamps intestinales  
 Pinze intestinal i



**DOYEN**



21,0 cm, 8<sup>1</sup>/<sub>4</sub>" **164-210-21**  
 23,0 cm, 9" **164-210-23**



21,0 cm, 8<sup>1</sup>/<sub>4</sub>" **164-211-21**  
 23,0 cm, 9" **164-211-23**

mit atraumatischer Zahnung  
 with atraumatic serration  
 con bacos atraumáticas  
 con morsi atraumatici



**KOCHER**



22,0 cm, 8<sup>5</sup>/<sub>8</sub>" **160-234-22**  
 25,0 cm, 9<sup>3</sup>/<sub>4</sub>" **160-234-25**  
 28,0 cm, 11" **160-234-28**

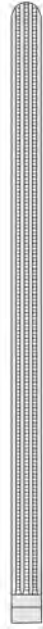


22,0 cm, 8<sup>5</sup>/<sub>8</sub>" **160-235-22**  
 25,0 cm, 9<sup>3</sup>/<sub>4</sub>" **160-235-25**  
 28,0 cm, 11" **160-235-28**



mit atraumatischer Zahnung  
with atraumatic serration  
con bacos atraumáticas  
con morsi atraumatici

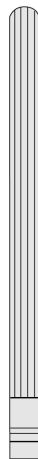
**KOCHER**



22,0 cm, 8 <sup>5</sup> / <sub>8</sub> "	<b>164-234-22</b>	22,0 cm, 8 <sup>5</sup> / <sub>8</sub> "	<b>164-235-22</b>
25,0 cm, 9 <sup>3</sup> / <sub>4</sub> "	<b>164-234-25</b>	25,0 cm, 9 <sup>3</sup> / <sub>4</sub> "	<b>164-235-25</b>
28,0 cm, 11"	<b>164-234-28</b>	28,0 cm, 11"	<b>164-235-28</b>

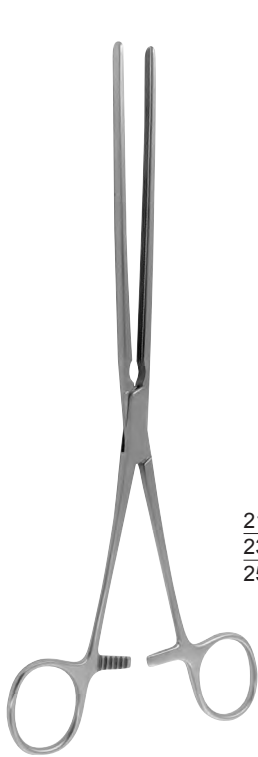


**MAYO-ROBSON**



21,0 cm, 8 <sup>1</sup> / <sub>4</sub> "	<b>160-230-21</b>	21,0 cm, 8 <sup>1</sup> / <sub>4</sub> "	<b>160-231-21</b>
23,0 cm, 9"	<b>160-230-23</b>	23,0 cm, 9"	<b>160-231-23</b>
25,0 cm, 9 <sup>3</sup> / <sub>4</sub> "	<b>160-230-25</b>	25,0 cm, 9 <sup>3</sup> / <sub>4</sub> "	<b>160-231-25</b>

Darmklemmen  
 Intestinal Clamp Forceps  
 Pinzas-clamps intestinales  
 Pinze intestinali

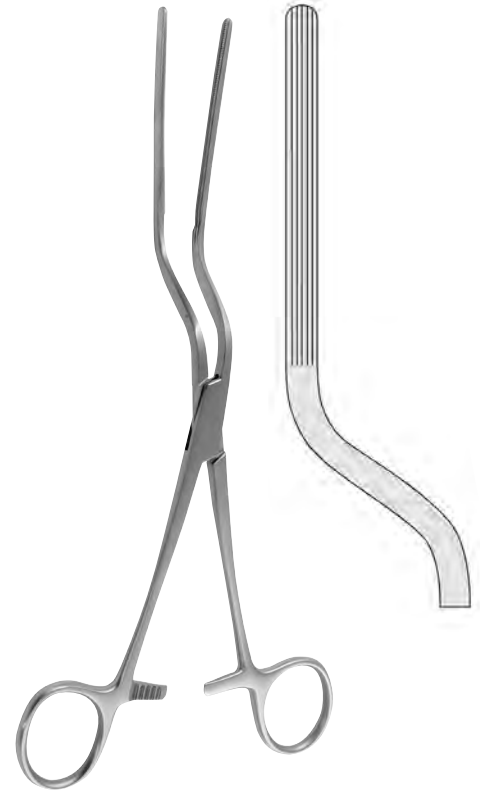


**MAYO-ROBSON**

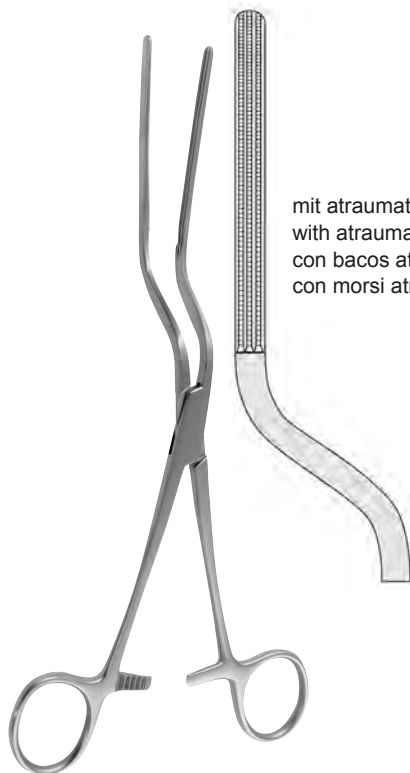
21,0 cm, 8<sup>1</sup>/<sub>4</sub>" **164-230-21**  
 23,0 cm, 9" **164-230-23**  
 25,0 cm, 9<sup>3</sup>/<sub>4</sub>" **164-230-25**

21,0 cm, 8<sup>1</sup>/<sub>4</sub>" **164-231-21**  
 23,0 cm, 9" **164-231-23**  
 25,0 cm, 9<sup>3</sup>/<sub>4</sub>" **164-231-25**

mit atraumatischer Zahnung  
 with atraumatic serration  
 con bacos atraumáticos  
 con morsi atraumatici

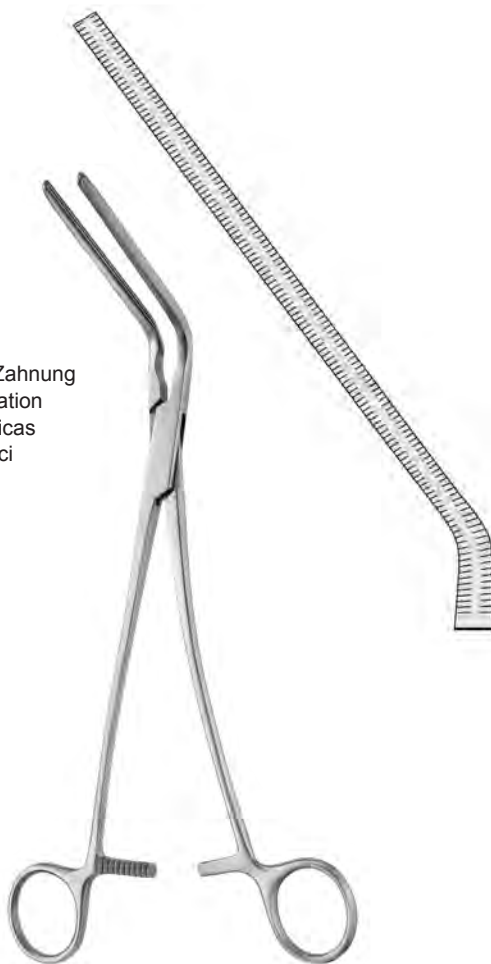


**BRUNNER**  
 24,0 cm, 9<sup>1</sup>/<sub>2</sub>"  
**160-240-24**



**BRUNNER**  
 24,0 cm, 9<sup>1</sup>/<sub>2</sub>"  
**164-240-24**

mit atraumatischer Zahnung  
 with atraumatic serration  
 con bacos atraumáticos  
 con morsi atraumatici



**GLASSMAN**  
 23,0 cm, 9"  
**160-259-23**



**GLASSMAN**  
 23,5 cm, 9<sup>1</sup>/<sub>4</sub>"  
**160-253-23**



Maußlänge  
length of jaws  
longitud de la boca  
bocche lungh

5,0 cm, 2"	<b>160-320-05</b>
7,0 cm, 2 1/2"	<b>160-320-07</b>
10,0 cm, 4"	<b>160-320-10</b>

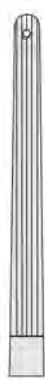
**DE MARTEL-WOLFSON**



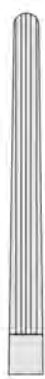
**DE MARTEL-WOLFSON**  
8,5 cm, 3 1/2"  
**160-340-08**



**DE MARTEL-WOLFSON**  
26,0 cm, 10 1/4"  
**160-325-26**



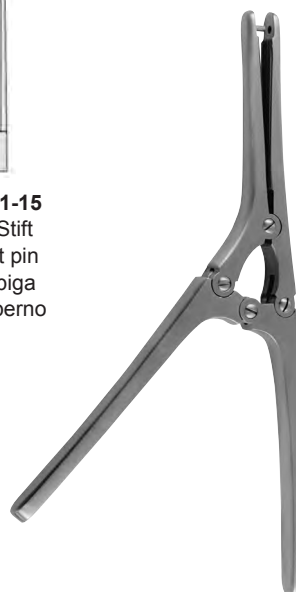
**160-310-15**  
mit Stift  
with pin  
con espiga  
con perno



**160-311-15**  
ohne Stift  
without pin  
sin espiga  
senza perno



**BABY-PAYR**  
15,0 cm, 6"



**PAYR**

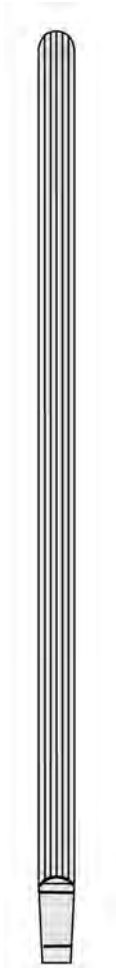


21,0 cm, 8 1/4"	<b>160-310-21</b>	<b>160-311-21</b>
29,0 cm, 11 1/2"	<b>160-310-29</b>	<b>160-311-29</b>

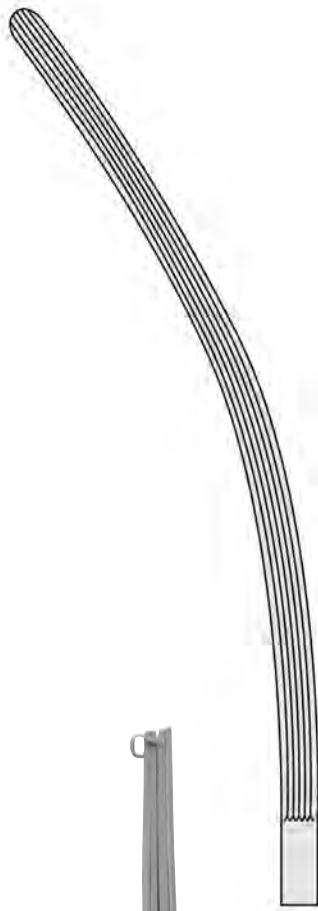


mit Stift with pin con espiga con perno	ohne Stift without pin sin espiga senza perno
--	--

Darm- und Magenklappen  
 Intestinal and Stomach Clamp Forceps  
 Pinzas-clamps intestinales y estomacales  
 Pinze per intestino e stomaco



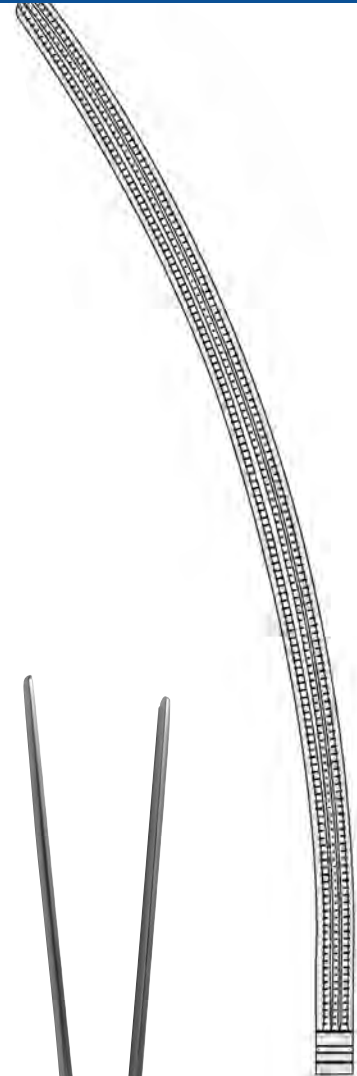
160-360-30



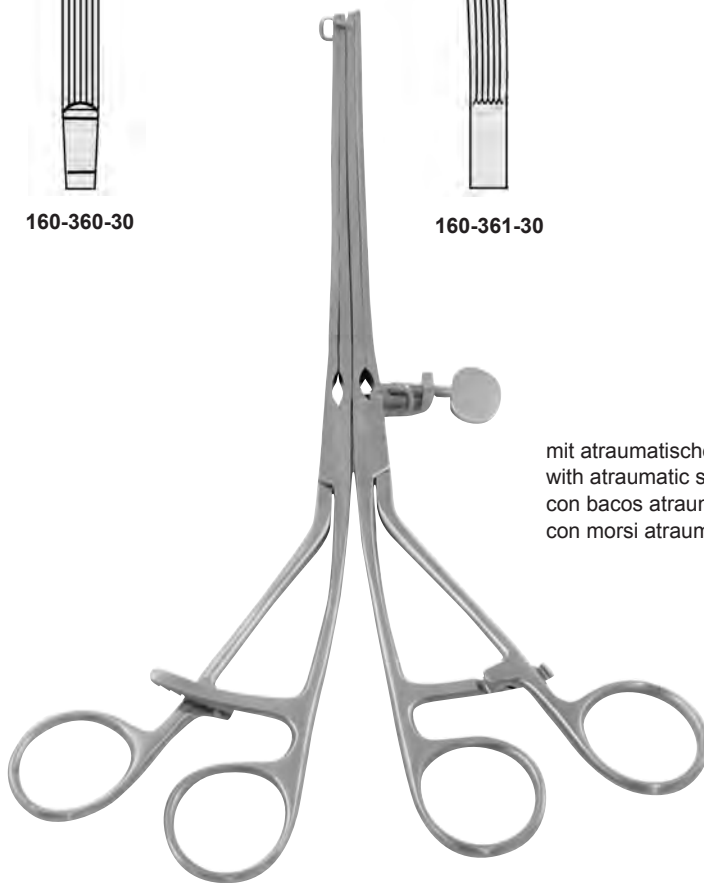
160-361-30



160-364-33

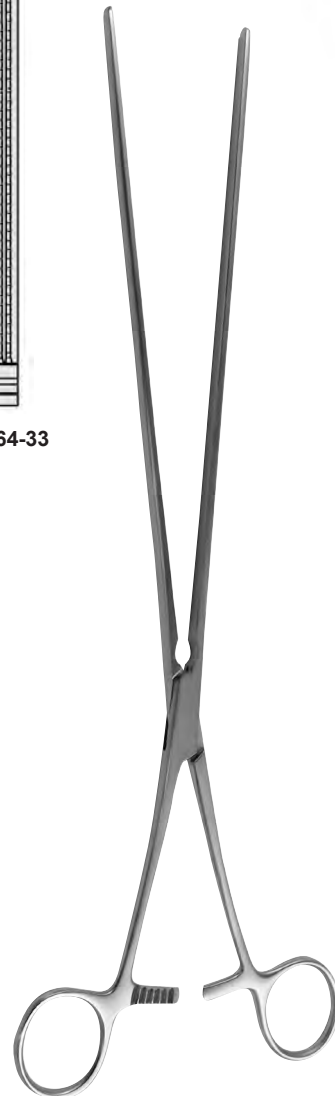


160-365-33



**LANE**  
 30,0 cm, 11<sup>3</sup>/<sub>4</sub>"

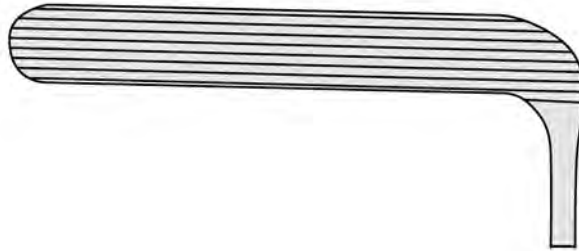
mit atraumatischer Zahnung  
 with atraumatic serration  
 con bacos atraumáticas  
 con morsi atraumatici



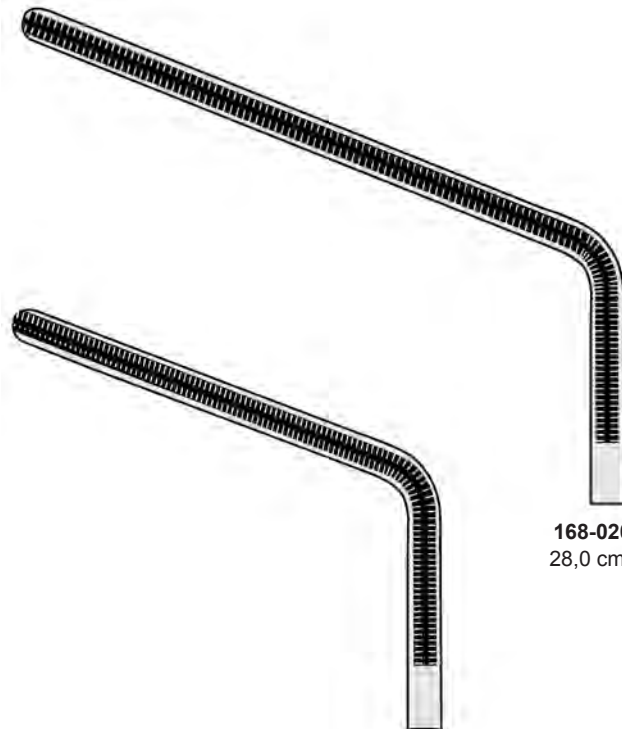
**SCUDDER**  
 33,0 cm, 13"



**MIKULICZ**  
19,0 cm, 7 1/2"  
168-010-19



**HAYES**



**168-020-28**  
28,0 cm, 11"

**168-020-26**  
26,0 cm, 10"

Mastdarm-Rektum-Spekula  
Rectal Specula  
Espéculos para el recto  
Speculi rectali



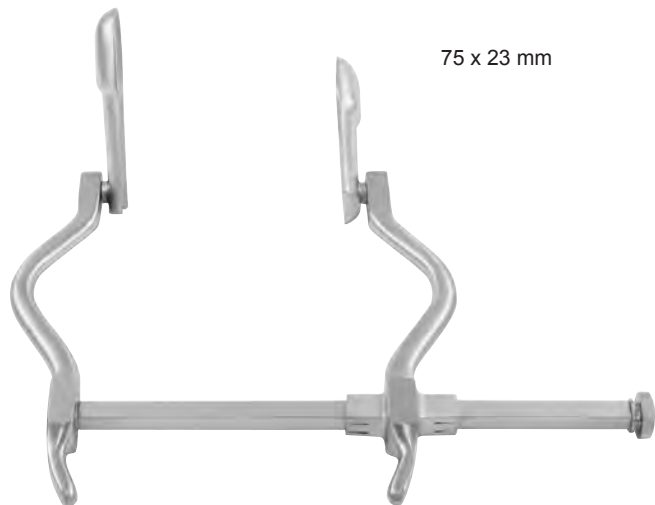
**SIMS**  
15,0 cm, 6"  
168-108-15



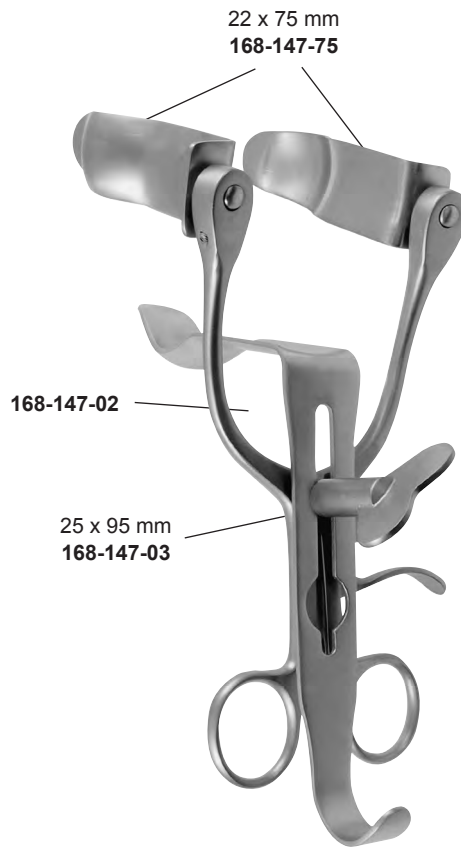
**SIMS**  
15,0 cm, 6"  
168-110-15



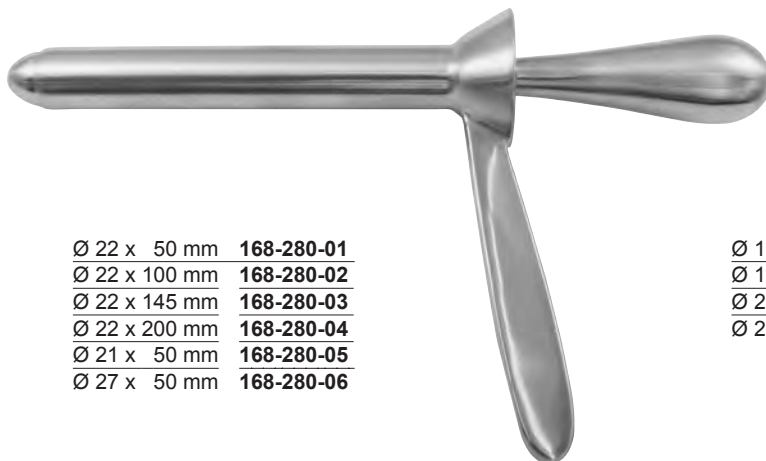
**MATHIEU**  
21,0 cm, 8<sup>1</sup>/<sub>4</sub>"  
168-150-21



**SMITH-BUIE**  
15,0 cm, 6"  
168-160-15



**ALAN PARKS**  
13,5 cm, 5<sup>3</sup>/<sub>8</sub>"  
**168-147-00**



- Ø 22 x 50 mm **168-280-01**
- Ø 22 x 100 mm **168-280-02**
- Ø 22 x 145 mm **168-280-03**
- Ø 22 x 200 mm **168-280-04**
- Ø 21 x 50 mm **168-280-05**
- Ø 27 x 50 mm **168-280-06**

**HAYES**



- Ø 16 x 65 mm **168-212-01**
- Ø 19 x 65 mm **168-212-02**
- Ø 22 x 65 mm **168-212-03**
- Ø 22 x 130 mm **168-212-04**

**HIRSCHMANN**



Anuskope, Proktoskope  
Anoscope, Proctoscopes  
Anoscopios, Proctoscopios  
Anoscopi, Proscopi



Ø 22 x 65 mm **168-250-22**  
Ø 30 x 65 mm **168-250-30**

**CHELSEA EATON**



ohne Kaltlichtträger  
without cold light carrier  
sin portador para luz fría  
senza luce fredda

**IVES FANSLER**  
Ø 22 mm  
**168-268-01**

mit Kaltlichtträger  
with cold light carrier  
con portador para luz fría  
con luce fredda

**IVES FANSLER**  
Ø 22 mm  
**168-268-02**



28,0 cm, 11" **168-300-28**  
 35,0 cm, 13<sup>3</sup>/<sub>4</sub>" **168-300-35**  
 42,0 cm, 16<sup>1</sup>/<sub>2</sub>" **168-300-42**



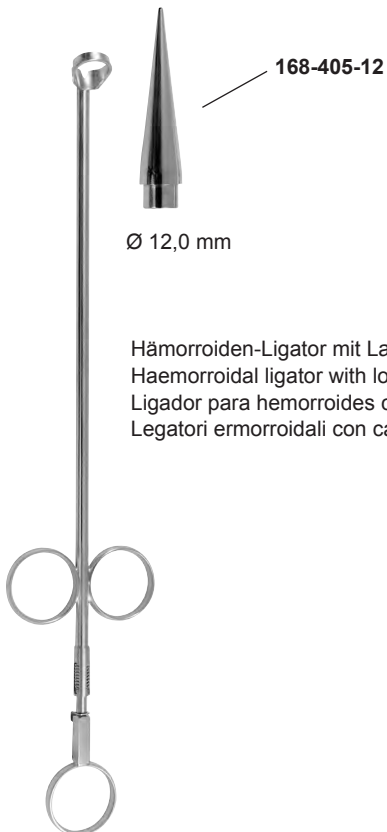
28,0 cm, 11" **168-311-28**  
 35,0 cm, 13<sup>3</sup>/<sub>4</sub>" **168-311-35**  
 42,0 cm, 16<sup>1</sup>/<sub>2</sub>" **168-311-42**



28,0 cm, 11" **168-301-28**  
 35,0 cm, 13<sup>3</sup>/<sub>4</sub>" **168-301-35**  
 42,0 cm, 16<sup>1</sup>/<sub>2</sub>" **168-301-42**



28,0 cm, 11" **168-312-28**  
 35,0 cm, 13<sup>3</sup>/<sub>4</sub>" **168-312-35**  
 42,0 cm, 16<sup>1</sup>/<sub>2</sub>" **168-312-42**



**RUDD**  
**168-400-00**

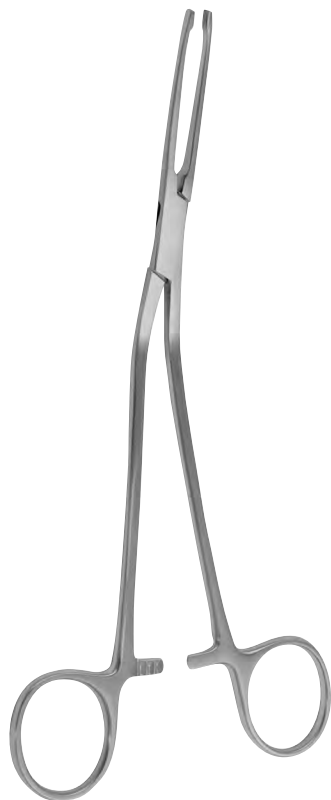


**MC GIVNEY**  
**168-410-00**

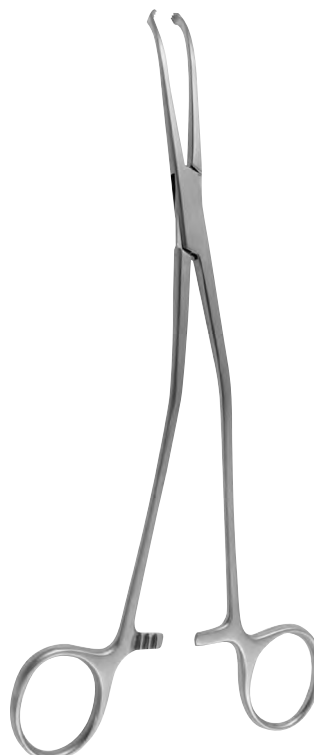
Hämorrhoiden-Ligator mit Ladekonus  
 Haemorrhoidal ligator with loading attachment  
 Ligador para hemorroides con cono de carga  
 Legatori emorroidali con carica a cono

Hämorrhoiden-Ligator mit Ladekonus  
 Haemorrhoidal ligator with loading attachment  
 Ligador para hemorroides con cono de carga  
 Legatori emorroidali con carica a cono

Hämorrhoiden-Faßzangen, Fistelsonden  
Haemorrhoidal Forceps, Fistula probes  
Pinza-clamps para hemorroides, Sondas para fistula  
Pinze per emorroidi, Sonde per fistola



**MC GIVNEY**  
19,0 cm, 7<sup>1</sup>/<sub>2</sub>"  
168-471-19



**MC GIVNEY**  
19,0 cm, 7<sup>1</sup>/<sub>2</sub>"  
168-473-19



**PRATT**  
21,0 cm, 8<sup>1</sup>/<sub>4</sub>"



080-135-01



080-135-02



080-135-03

**Gynäkologie, Geburtshilfe**  
**Gynecology, Obstetrics**  
**Ginecología, Obstetricia**  
**Ginecologia, Ostetricia**

Scheidenspekula  
 Vaginal Specula  
 Espéculos vaginales  
 Speculi vaginali

für Jungfrauen  
 for virgins  
 para virgenes  
 per vergini

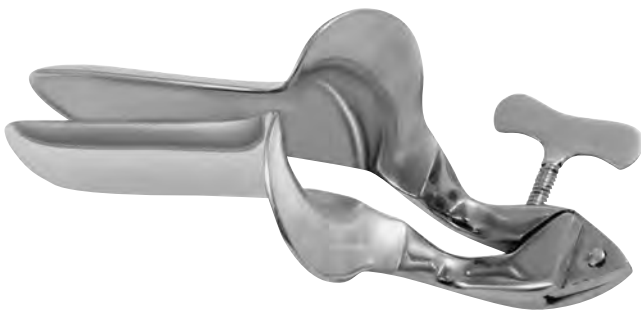


**COLLIN**  
 65 x 10 mm  
 180-132-00

für Kinder  
 for children  
 para niños  
 per bambini



**COLLIN**  
 65 x 10 mm  
 180-134-00



**COLLIN**

85 x 30 mm	<b>180-130-01</b>
100 x 35 mm	<b>180-130-02</b>
110 x 40 mm	<b>180-130-03</b>



80 x 24 mm	<b>180-142-01</b>
80 x 32 mm	<b>180-142-02</b>
98 x 16 mm	<b>180-142-03</b>
105 x 25 mm	<b>180-142-04</b>
107 x 29 mm	<b>180-142-05</b>
115 x 35 mm	<b>180-142-06</b>



zentrale Stellschraube  
central fixation screw  
tornillo de sujeto central  
vite di regolazione centrale



**CUSCO**

75 x 32 mm	<b>180-144-01</b>
85 x 36 mm	<b>180-144-02</b>
95 x 37 mm	<b>180-144-03</b>

seitliche Stellschraube  
lateral fixation screw  
tornillo de sujeto lateral  
vite di regolazione laterale



für Jungfrauen  
for virgins  
para virgenes  
per vergini

**CUSCO**

75 x 17 mm	<b>180-140-00</b>
------------	-------------------

seitliche Stellschraube  
lateral fixation screw  
tornillo de sujeto lateral  
vite di regolazione laterale



**CUSCO**

75 x 32 mm	<b>180-140-01</b>
85 x 35 mm	<b>180-140-02</b>
100 x 35 mm	<b>180-140-03</b>

Schweizer Modell  
Swiss pattern  
Modelo suizo  
Modello svizzero



**CUSCO**

90 x 23-25 mm	<b>180-146-01</b>
100 x 25-27 mm	<b>180-146-02</b>
110 x 27-30 mm	<b>180-146-03</b>

Scheidenspekula  
 Vaginal Specula  
 Espéculos vaginales  
 Speculi vaginali



**GRAVE**

75 x 20 mm	<b>180-100-01</b>
95 x 35 mm	<b>180-100-02</b>
115 x 35 mm	<b>180-100-03</b>



**PEDERSON**

75 x 13 mm	<b>180-120-01</b>
100 x 22 mm	<b>180-120-02</b>
120 x 25 mm	<b>180-120-03</b>



**SEMM**

90 x 14-18 mm	<b>180-150-01</b>
100 x 17-20 mm	<b>180-150-02</b>
100 x 25-30 mm	<b>180-150-03</b>



**WEISSBARTH**  
 21,0 cm, 8<sup>1</sup>/<sub>4</sub>"  
**180-160-00**



mit abnehmbarem Gewicht  
with detachable weight  
con peso desmontable  
con peso smontabile

1,14 kg

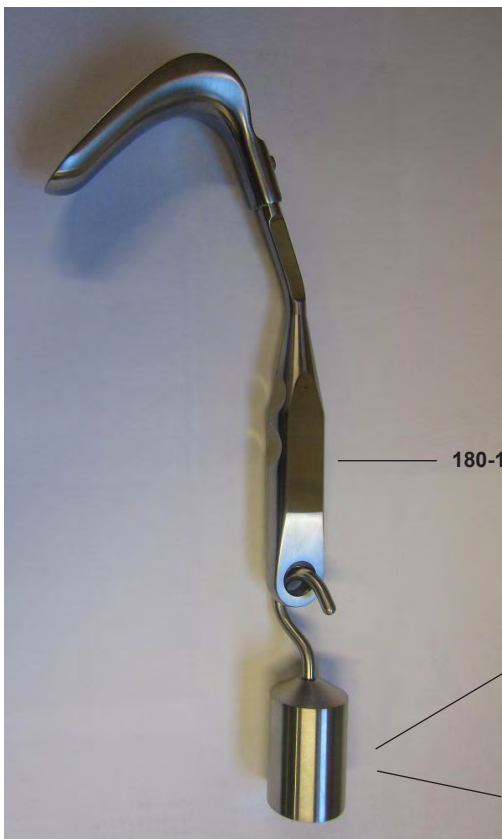
**AUVARD**  
75 x 38 mm  
180-170-00



mit festem Gewicht  
with fixed weight  
con peso fijo  
con peso fisso

1,14 kg

**AUVARD**  
75 x 38 mm  
180-172-00



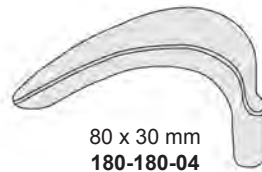
180-180-03

400 g  
180-180-40

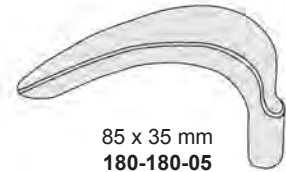
800 g  
180-180-80

**SCHERBACK**  
180-180-00

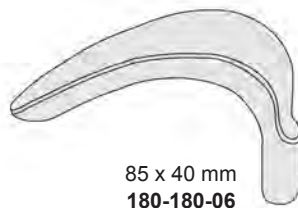
koplett, complete, completo, completo



80 x 30 mm  
180-180-04



85 x 35 mm  
180-180-05



85 x 40 mm  
180-180-06



55 x 40-60 mm  
180-180-07



70 x 45-70 mm  
180-180-08



Scheidenspekula  
Vaginal Specula  
Espéculos vaginales  
Speculi vaginali



Satz  
Set  
Juego  
Set

**KRISTELLER**

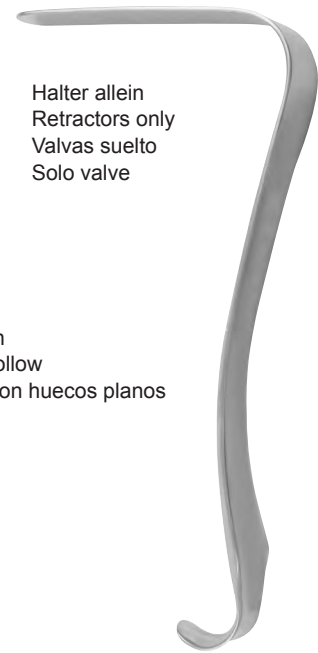
Fig. 1 **180-220-01**  
Fig. 2 **180-220-02**  
Fig. 3 **180-220-03**



Spekula allein, flach  
Specula only, flat hollow  
Espéculos suelto, con huecos planos  
Solo speculi, piatta

**KRISTELLER**

105 x 26 mm **180-221-01**  
105 x 28 mm **180-221-02**  
105 x 33 mm **180-221-03**



Halter allein  
Retractors only  
Valvas suelto  
Solo valve

**KRISTELLER**

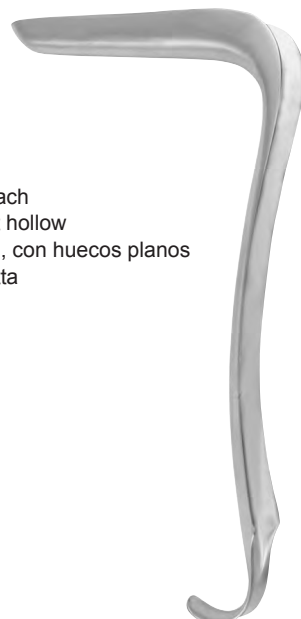
115 x 22 mm **180-222-01**  
115 x 24 mm **180-222-02**  
115 x 29 mm **180-222-03**



Satz  
Set  
Juego  
Set

**KRISTELLER**

Fig. 1 **180-230-01**  
Fig. 2 **180-230-02**  
Fig. 3 **180-230-03**



Spekula allein, flach  
Specula only, flat hollow  
Espéculos suelto, con huecos planos  
Solo speculi, piatta

**KRISTELLER**

110 x 27 mm **180-231-01**  
110 x 30 mm **180-231-02**  
110 x 36 mm **180-231-03**



Halter allein  
Retractors only  
Valvas suelto  
Solo valve

**KRISTELLER**

115 x 23 mm **180-232-01**  
115 x 26 mm **180-232-02**  
115 x 32 mm **180-232-03**



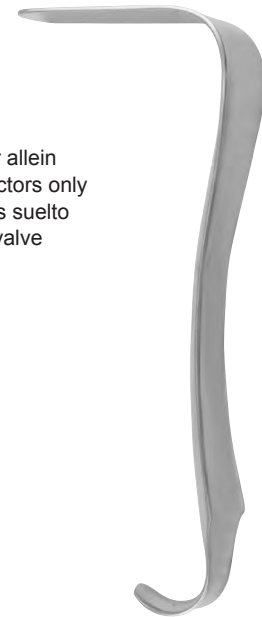
Satz  
 Set  
 Juego  
 Set

**KRISTELLER**  
 Fig. 0 **180-234-00**  
 Fig. 1 **180-234-01**  
 Fig. 2 **180-234-02**  
 Fig. 3 **180-234-03**



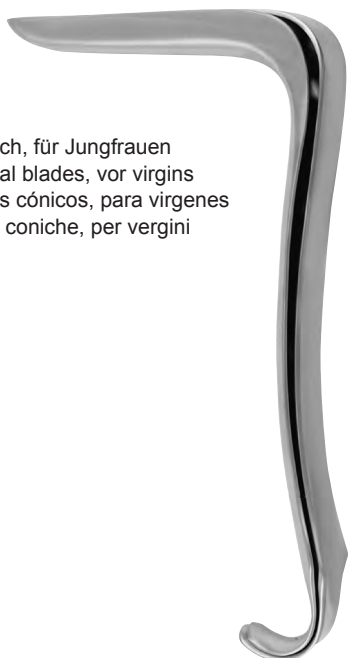
Spekula allein  
 Specula only  
 Espéculos suelto  
 Solo speculi

**KRISTELLER**  
 70 x 15 mm **180-235-00**  
 70 x 27 mm **180-235-01**  
 80 x 30 mm **180-235-02**  
 90 x 36 mm **180-235-03**



Halter allein  
 Retractors only  
 Valvas suelto  
 Solo valve

**KRISTELLER**  
 75 x 10 mm **180-236-00**  
 75 x 23 mm **180-236-01**  
 85 x 26 mm **180-236-02**  
 100 x 32 mm **180-236-03**



konisch, für Jungfrauen  
 conical blades, for virgins  
 valvos cónicos, para vírgenes  
 valve coniche, per vergini

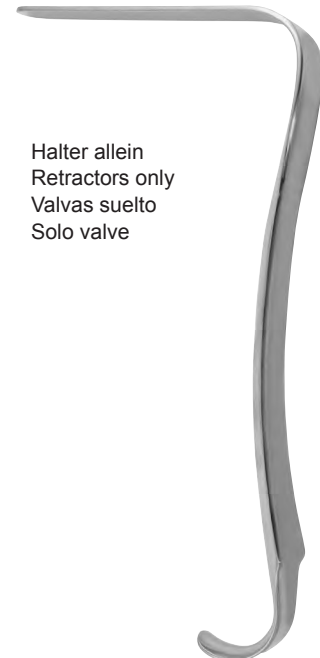
**KRISTELLER**  
 Fig. 00 **180-237-01**  
 Fig. 0 **180-237-02**



Spekula allein  
 Specula only  
 Espéculos suelto  
 Solo speculi

Satz  
 Set  
 Juego  
 Set

**KRISTELLER**  
 105 x 18 mm **180-238-01**  
 105 x 21 mm **180-238-02**



Halter allein  
 Retractors only  
 Valvas suelto  
 Solo valve

**KRISTELLER**  
 110 x 14 mm **180-239-01**  
 110 x 17 mm **180-239-02**

Scheidenspekula  
Vaginal Specula  
Espéculos vaginales  
Speculi vaginali



leicht hohl  
slightly-concave  
ligeremente concavos  
leggeremente concavi

Fig	a x b	
1	55 x 35 mm	<b>180-260-01</b>
2	85 x 35 mm	<b>180-260-02</b>
3	115 x 35 mm	<b>180-260-03</b>

1	55 x 45 mm	<b>180-261-01</b>
2	85 x 45 mm	<b>180-261-02</b>
3	115 x 45 mm	<b>180-261-03</b>
4	160 x 45 mm	<b>180-261-04</b>

1	55 x 60 mm	<b>180-262-01</b>
2	85 x 60 mm	<b>180-262-02</b>
3	115 x 60 mm	<b>180-262-03</b>
4	160 x 60 mm	<b>180-262-04</b>

**DOYEN**  
23,0 cm, 9"



halb-hohl  
medium-concave  
semi-concavos  
semi-concavi

Fig	a x b	
1	55 x 35 mm	<b>180-264-01</b>
2	85 x 35 mm	<b>180-264-02</b>
3	115 x 35 mm	<b>180-264-03</b>

1	55 x 45 mm	<b>180-265-01</b>
2	85 x 45 mm	<b>180-265-02</b>
3	115 x 45 mm	<b>180-265-03</b>

1	55 x 60 mm	<b>180-266-01</b>
2	85 x 60 mm	<b>180-266-02</b>
3	115 x 60 mm	<b>180-266-03</b>

**DOYEN**  
23,0 cm, 9"



Satz  
 Set  
 Juego  
 Set

**KALLMORGEN**

70 x 40 mm **180-270-01**  
 90 x 40 mm **180-270-02**



Spekula allein  
 Specula only  
 Espéculos suelto  
 Solo speculi

**KALLMORGEN**

70 x 40 mm **180-271-01**  
 90 x 40 mm **180-271-02**



Halter allein  
 Retractors only  
 Valvas suelto  
 Solo valve

**KALLMORGEN**

70 x 40 mm **180-272-01**  
 90 x 40 mm **180-272-02**



70 x 15 mm

**KRISTELLER**

17,0 cm, 6<sup>3</sup>/<sub>4</sub>"  
**180-275-17**



75 x 39 mm

**KALLMORGEN**

17,0 cm, 6<sup>3</sup>/<sub>4</sub>"  
**180-290-17**



**JACKSON**

75 x 38 mm **180-290-01**  
 90 x 38 mm **180-290-02**  
 100 x 38 mm **180-290-03**

Scheidenspekula  
Vaginal Specula  
Espéculos vaginales  
Speculi vaginali

76 x 25 mm



70 x 22 mm

**BREISKY**  
14,0 cm, 5½"  
**180-292-01**

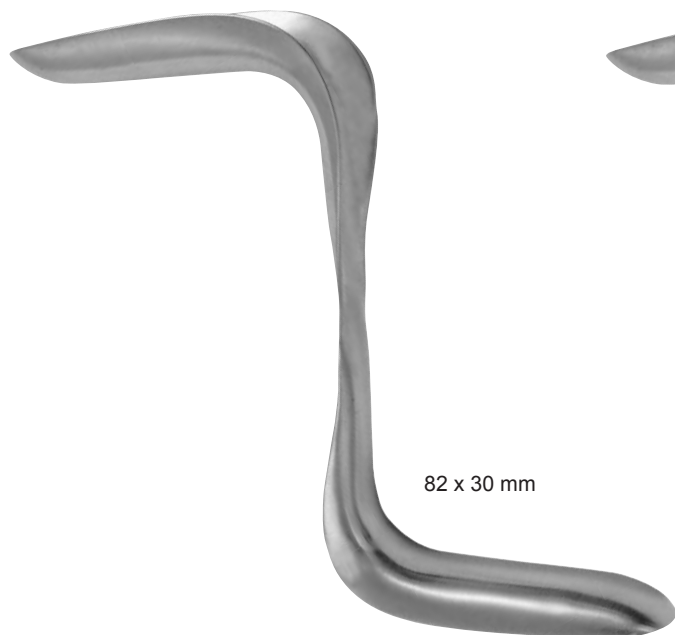
82 x 30 mm



76 x 25 mm

**BREISKY**  
14,0 cm, 5½"  
**180-292-02**

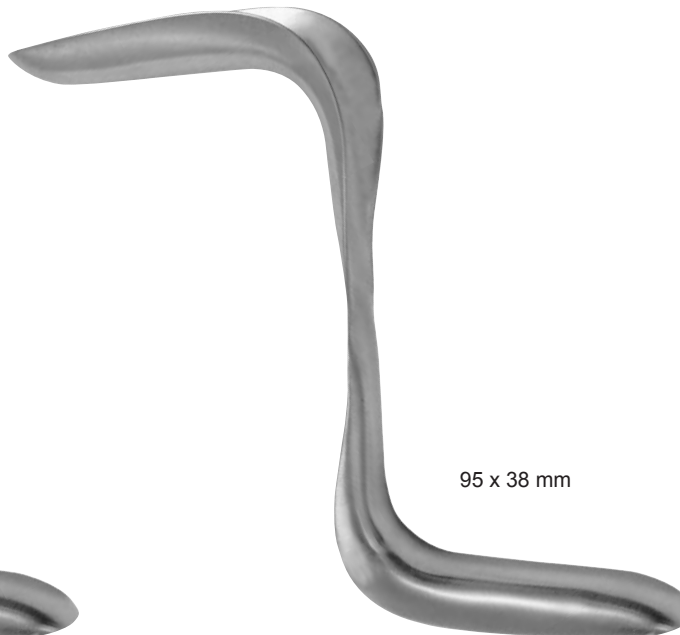
95 x 38 mm



82 x 30 mm

**BREISKY**  
17,0 cm, 6¾"  
**180-292-03**

102 x 44 mm

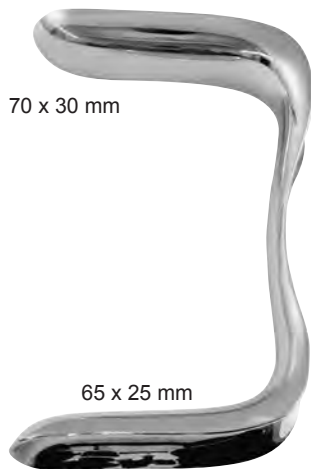


95 x 38 mm

**BREISKY**  
17,0 cm, 6¾"  
**180-292-04**



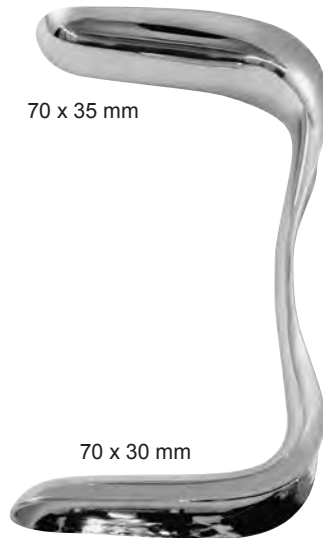
**SIMS**  
**57-8294-00**  
Satz, Set, Juego, Set, набор



70 x 30 mm

65 x 25 mm

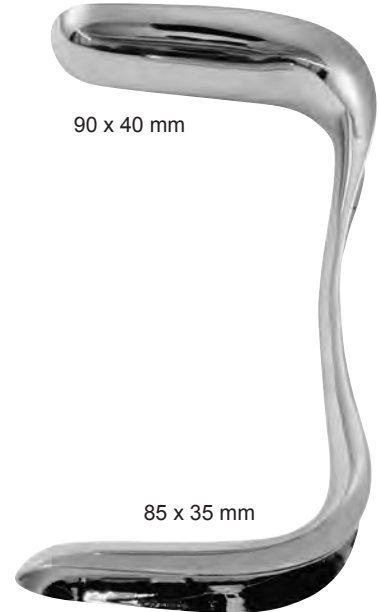
**SIMS**  
12,5 cm, 5"  
**180-294-01**



70 x 35 mm

70 x 30 mm

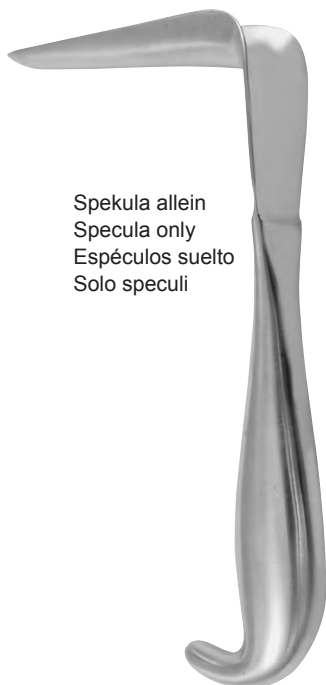
**SIMS**  
15,0 cm, 6"  
**180-294-02**



90 x 40 mm

85 x 35 mm

**SIMS**  
17,5 cm, 7"  
**180-294-03**



Spekula allein  
Specula only  
Espéculos sueltos  
Solo speculi

**MATHIEU**

100 x 13-23 mm **180-300-01**  
100 x 16-30 mm **180-300-02**



Halter allein  
Retractors only  
Valvas sueltos  
Solo valve

**MATHIEU**

100 x 11-21 mm **180-301-01**  
100 x 14-27 mm **180-301-02**



**LANDAU**

100 x 28 mm **180-305-01**  
100 x 38 mm **180-305-02**

Scheidenspekula  
 Vaginal Specula  
 Espéculos vaginales  
 Speculi vaginali



100 x 20 mm	<b>180-307-20</b>
100 x 25 mm	<b>180-307-25</b>
100 x 30 mm	<b>180-307-30</b>
100 x 35 mm	<b>180-307-35</b>
100 x 40 mm	<b>180-307-40</b>
<hr/>	
130 x 20 mm	<b>180-308-20</b>
130 x 25 mm	<b>180-308-25</b>
130 x 30 mm	<b>180-308-30</b>
130 x 35 mm	<b>180-308-35</b>
130 x 40 mm	<b>180-308-40</b>
<hr/>	
155 x 40 mm	<b>180-309-40</b>

**BREISKY**



85 x 17 mm

**BRAUN, MODIF.**  
 19,0 cm, 7 1/2"  
**180-313-19**



60 x 30 mm

**DOYEN**  
 23,0 cm, 9"  
**180-315-23**



80 x 30 mm

**DOYEN**  
 25,0 cm, 9"  
**180-315-25**



95 x 38 mm

**WERTHEIM**  
 30,0 cm, 12"  
**180-317-30**



**IZIAL DENTAL SURGICAL**  
Manufacturer And Exporter Of Surgical Dental & Manicure

Endospekula, Lateral-Spekulum, Intrauterinsonde  
Endospecula, Lateral Speculum, Intrauterine Probe  
Endoespéculos, Espéculo lateral, Sonda intra-uterina  
Endospeculi, Speculo lateral, Sonde intrauterine



3,0 mm

180-092-03

4,0 mm

180-092-04

5,0 mm

**KOGAN**  
24,0 cm, 9 1/2"

180-092-05



3,0 mm

180-090-03

4,0 mm

180-090-04

5,0 mm

**KOGAN**  
24,0 cm, 9 1/2"

180-090-05



Uterus-Dilatatoren  
 Uterine Dilators  
 Dilataores uterinos  
 Dilatatori uterini



- Ø 1,0 mm **180-350-01**
- Ø 2,0 mm **180-350-02**
- Ø 3,0 mm **180-350-03**
- Ø 4,0 mm **180-350-04**
- Ø 5,0 mm **180-350-05**
- Ø 6,0 mm **180-350-06**
- Ø 7,0 mm **180-350-07**
- Ø 8,0 mm **180-350-08**
- Ø 9,0 mm **180-350-09**
- Ø 10,0 mm **180-350-10**
- Ø 11,0 mm **180-350-11**
- Ø 12,0 mm **180-350-12**
- Ø 13,0 mm **180-350-13**
- Ø 14,0 mm **180-350-14**
- Ø 15,0 mm **180-350-15**
- Ø 16,0 mm **180-350-16**
- Ø 17,0 mm **180-350-17**
- Ø 18,0 mm **180-350-18**
- Ø 19,0 mm **180-350-19**
- Ø 20,0 mm **180-350-20**
- Ø 21,0 mm **180-350-21**
- Ø 22,0 mm **180-350-22**
- Ø 23,0 mm **180-350-23**
- Ø 24,0 mm **180-350-24**
- Ø 25,0 mm **180-350-25**
- Ø 26,0 mm **180-350-26**

**HEGAR**  
 18,5 cm, 7¼"



- Ø 1,5 mm **180-351-01**
- Ø 2,5 mm **180-351-02**
- Ø 3,5 mm **180-351-03**
- Ø 4,5 mm **180-351-04**
- Ø 5,5 mm **180-351-05**
- Ø 6,5 mm **180-351-06**
- Ø 7,5 mm **180-351-07**
- Ø 8,5 mm **180-351-08**
- Ø 9,5 mm **180-351-09**
- Ø 10,5 mm **180-351-10**
- Ø 11,5 mm **180-351-11**
- Ø 12,5 mm **180-351-12**
- Ø 13,5 mm **180-351-13**
- Ø 14,5 mm **180-351-14**
- Ø 15,5 mm **180-351-15**
- Ø 16,5 mm **180-351-16**
- Ø 17,5 mm **180-351-17**

**HEGAR**  
 18,5 cm, 7¼"



205 x 105 x 45 mm

**HEGAR**  
**180-350-99**  
 Satz, Set, Juego, Set  
 Ø 1,0 - Ø 26,0  
 (26 dilators)

**HEGAR**  
**180-350-98**  
 Satz, Set, Juego, Set  
 Ø 4,0 - Ø 17,0  
 (14 dilators)



Ø 1,0 / 2,0 mm	<b>180-354-01</b>
Ø 3,0 / 4,0 mm	<b>180-354-03</b>
Ø 5,0 / 6,0 mm	<b>180-354-05</b>
Ø 7,0 / 8,0 mm	<b>180-354-07</b>
Ø 9,0 / 10,0 mm	<b>180-354-09</b>
Ø 11,0 / 12,0 mm	<b>180-354-11</b>
Ø 13,0 / 14,0 mm	<b>180-354-13</b>
Ø 15,0 / 16,0 mm	<b>180-354-15</b>
Ø 17,0 / 18,0 mm	<b>180-354-17</b>
Ø 19,0 / 20,0 mm	<b>180-354-19</b>
Ø 21,0 / 22,0 mm	<b>180-354-21</b>
Ø 23,0 / 24,0 mm	<b>180-354-23</b>
Ø 25,0 / 26,0 mm	<b>180-354-25</b>

**HEGAR**  
20,0 cm, 8"



**HEGAR**  
**180-354-98**

Satz, Set, Juego, Set  
Ø 3,0 / 4,0 - Ø 17,0 / 18,0 mm  
(8 dilators)

**HEGAR**  
**180-354-99**

Satz, Set, Juego, Set  
Ø 1,0 / 2,0 - Ø 25,0 / 26,0 mm  
(13 dilators)



Ø 4,5 / 5,0 mm	<b>180-360-05</b>
Ø 5,5 / 6,0 mm	<b>180-360-06</b>
Ø 6,5 / 7,0 mm	<b>180-360-07</b>
Ø 7,5 / 8,0 mm	<b>180-360-08</b>
Ø 8,5 / 9,0 mm	<b>180-360-09</b>
Ø 9,5 / 10,0 mm	<b>180-360-10</b>

**HANK**



**HANK**  
**180-360-98**

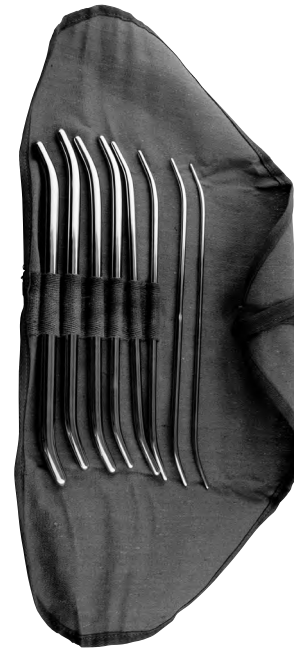
Satz, Set, Juego, Set  
Ø 4,5 / 5,0 - Ø 9,5 / 10,0 mm  
(6 dilators)

Uterus-Dilatatoren, Hakenzangen  
 Uterine Dilators, Uterine Tenaculum Forceps  
 Diladores uterinos, Pinzas para coger el cuello del útero  
 Dilatori uterini, Pinze per abbassare il collo dell'utero



**PRATT**

Ø 4,5 / 5,0 mm	<b>180-370-05</b>
Ø 5,5 / 6,0 mm	<b>180-370-06</b>
Ø 7,5 / 8,0 mm	<b>180-370-08</b>
Ø 8,5 / 9,0 mm	<b>180-370-09</b>
Ø 9,5 / 10,0 mm	<b>180-370-10</b>
Ø 11,5 / 12,0 mm	<b>180-370-12</b>
Ø 12,5 / 13,0 mm	<b>180-370-13</b>
Ø 13,5 / 14,0 mm	<b>180-370-14</b>



**PRATT**  
**180-370-98**  
 Satz, Set, Juego, Set  
 Ø 4,5 / 5,0 - Ø 13,5 / 14,0 mm  
 (8 dilators)



**BARRETT**  
 18,0 cm, 7"  
**180-410-18**



**ADAIR**  
 19,0 cm, 7 1/2"  
**180-412-19**



**STAUDE-MOORE**  
 17,0 cm, 6 3/4"  
**180-414-17**



**Hakenzangen**  
**Uterine Tenaculum Forceps**  
**Pinzas para coger el cuello del útero**  
**Pinze per abbassare il collo dell'utero**



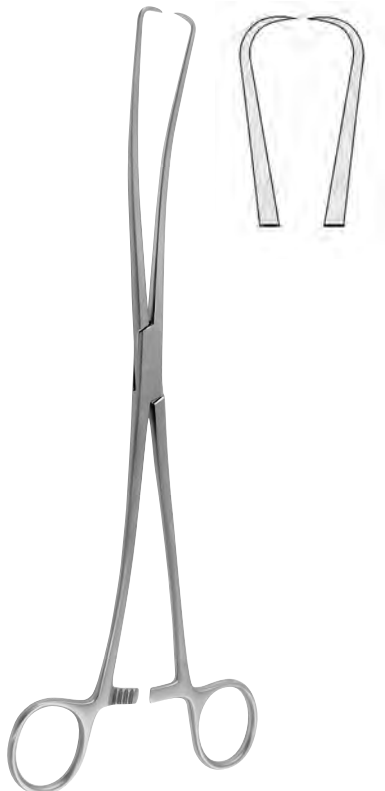
**JARCHO**  
20,0 cm, 8"  
180-417-20



**SCHROEDER**  
25,0 cm, 9<sup>3</sup>/<sub>4</sub>"  
180-400-25



**BRAUN**  
25,0 cm, 9<sup>3</sup>/<sub>4</sub>"  
180-404-25



**DUPLAY**  
28,0 cm, 11"  
180-419-28



**POZZI**  
26,0 cm, 10<sup>1</sup>/<sub>4</sub>"  
180-402-26



**KAHN**  
24,0 cm, 9<sup>1</sup>/<sub>2</sub>"  
180-421-24

Hakenzangen  
Uterine Tenaculum Forceps  
Pinzas para coger el cuello del útero  
Pinze per abbassare il collo dell'utero



**SKENE**  
24,0 cm, 9 1/2"  
180-423-24



**SCHROEDER**  
24,0 cm, 9 1/2"  
180-426-24



**SCHROEDER**  
24,0 cm, 9 1/2"  
180-429-24



**TEALE**  
23,0 cm, 9"  
180-431-23



**JACOBS**  
21,0 cm, 8 1/2"  
180-434-21



**JACOBS**  
21,0 cm, 8 1/2"  
180-435-21



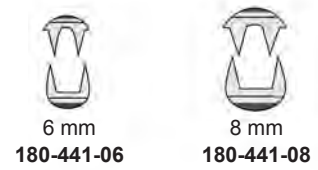
**Hakenzangen**  
**Uterine Tenaculum Forceps**  
**Pinzas para coger el cuello del útero**  
**Pinze per abbassare il collo dell'utero**



**MUSEUX**  
24,0 cm, 9 1/2"



**MUSEUX**  
24,0 cm, 9 1/2"



**BRAUN**  
15,5 cm, 6"  
180-442-15



**CZERNY**  
20,5 cm, 8"  
180-444-20



**PRATT**  
28,0 cm, 11"  
180-446-28

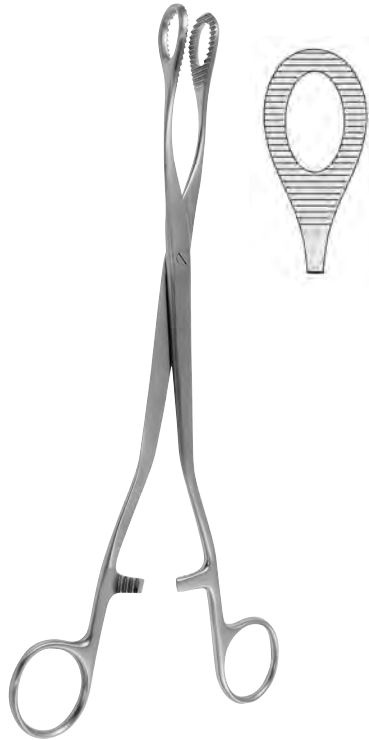


**IOWA**  
26,0 cm, 10 1/4"  
180-449-26

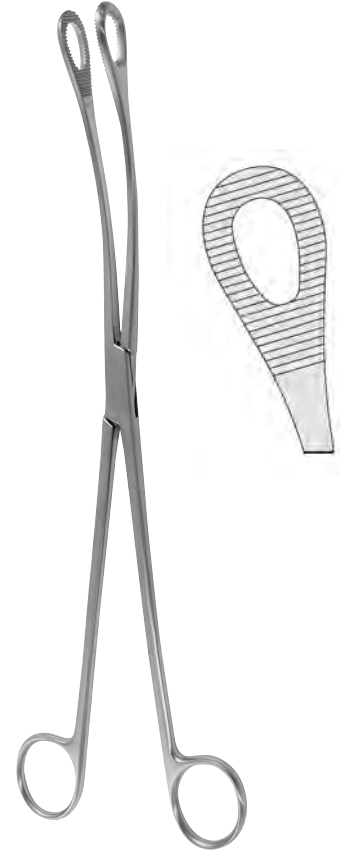
Polypen- und Ovarienzangen, Uterusfaßzangen  
 Polypus and Ovum Forceps, Uterine Elevating Forceps  
 Pinzas para pólipos uterinos y ovarios, Pinzas para la útero  
 Pinze per polipi e ovaie, Pinze per affarrare l'utero



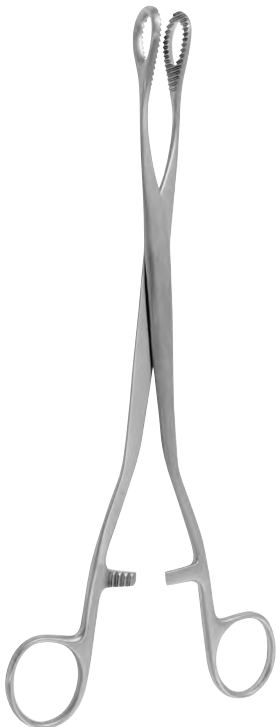
**DOYEN**  
 20,5 cm, 8"  
 180-470-20



**NOTO**  
 27,0 cm, 10<sup>5</sup>/<sub>8</sub>"  
 180-472-27



**KELLY**  
 32,0 cm, 12<sup>1</sup>/<sub>2</sub>"  
 180-475-32



**HEYWOOD-SMITH**  
 25,0 cm, 9<sup>3</sup>/<sub>4</sub>"  
 180-480-25



**DARTIGUES**  
 27,0 cm, 10<sup>3</sup>/<sub>4</sub>"  
 180-482-27



**SOMER**  
 23,0 cm, 9"  
 180-485-23



**Uterusfaßzangen, Uterussonden, Zentimereinteilung**  
**Uterine Elevating Forceps, Uterine Probes, graduated in centimeters**  
**Pinzas para la útero, Histerómetros, graduado en centímetros**  
**Pinze per affarrare l'utero, Isterometri, graduato in cm**



**COLLIN**  
25,0 cm, 9<sup>3</sup>/<sub>4</sub>"  
180-488-25



**BEACHAM**  
26,0 cm, 10<sup>1</sup>/<sub>4</sub>"  
180-500-26

Amniotom  
Amniotome  
Amniótomo  
Amniotomo



**BRAUN**  
28,0 cm, 11"  
180-502-28

Uterus-Depressor  
Uterine depressor  
Depresor uterino  
Depressori uterini



**SIMS**  
32,0 cm, 12<sup>1</sup>/<sub>2</sub>"  
180-510-32



**SIMS**  
32,0 cm, 12<sup>1</sup>/<sub>2</sub>"  
180-511-32

biegsam  
malleable  
maleable  
malleabile



**MARTIN**  
32,0 cm, 12<sup>1</sup>/<sub>2</sub>"  
180-516-32



**MARTIN**  
32,0 cm, 12<sup>1</sup>/<sub>2</sub>"  
180-518-32

biegsam  
malleable  
maleable  
malleabile



**VALLEIX**  
25,0 cm, 10"  
180-521-25

Ø 4 mm



**SIMPSON**  
29,0 cm, 11<sup>1</sup>/<sub>2</sub>"  
180-527-29

biegsam  
malleable  
maleable  
malleabile

Ø 4 mm



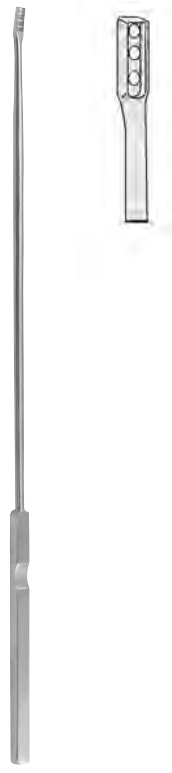
**COLLIN**  
28,0 cm, 11"  
180-529-28



Biopsieküretten  
 Biopsy Curettes  
 Curetas para biopsia  
 Curette per biopsia



**KEVORKIAN**  
 30,0 cm, 12"  
 180-540-30



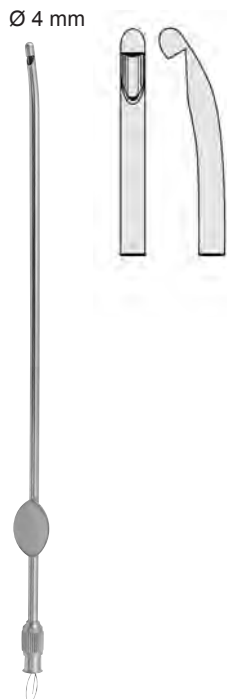
**KEVORKIAN**  
 30,0 cm, 12"  
 180-542-30



**KEVORKIAN**  
 30,0 cm, 12"  
 180-543-30



**NOVAK**  
 23,0 cm, 9"  
 180-550-04



**RANDALL**  
 23,0 cm, 9"  
 180-552-04



**MILAN**  
 29,0 cm, 11 1/2"

Ø 4 mm  
 180-560-04

Ø 6 mm  
 180-560-06

Ø 9 mm  
 180-560-09



25,0 cm, 9<sup>3</sup>/<sub>4</sub>"  
**180-570-25**



25,0 cm, 9<sup>3</sup>/<sub>4</sub>"  
**180-572-25**



**SIMON**  
22,0 cm, 8<sup>5</sup>/<sub>8</sub>"  
**180-574-22**



**EMMETT**  
22,0 cm, 8<sup>5</sup>/<sub>8</sub>"



**180-576-01**



**180-576-02**



**180-576-03**



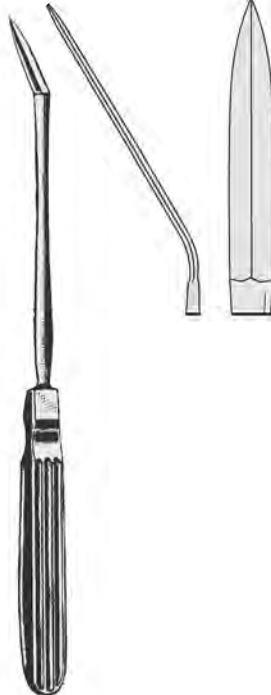
**180-576-04**



**180-576-05**



**SEGOND**  
27,0 cm, 10<sup>5</sup>/<sub>8</sub>"  
**180-580-27**



**AYRE**  
23,0 cm, 9"  
**180-583-23**

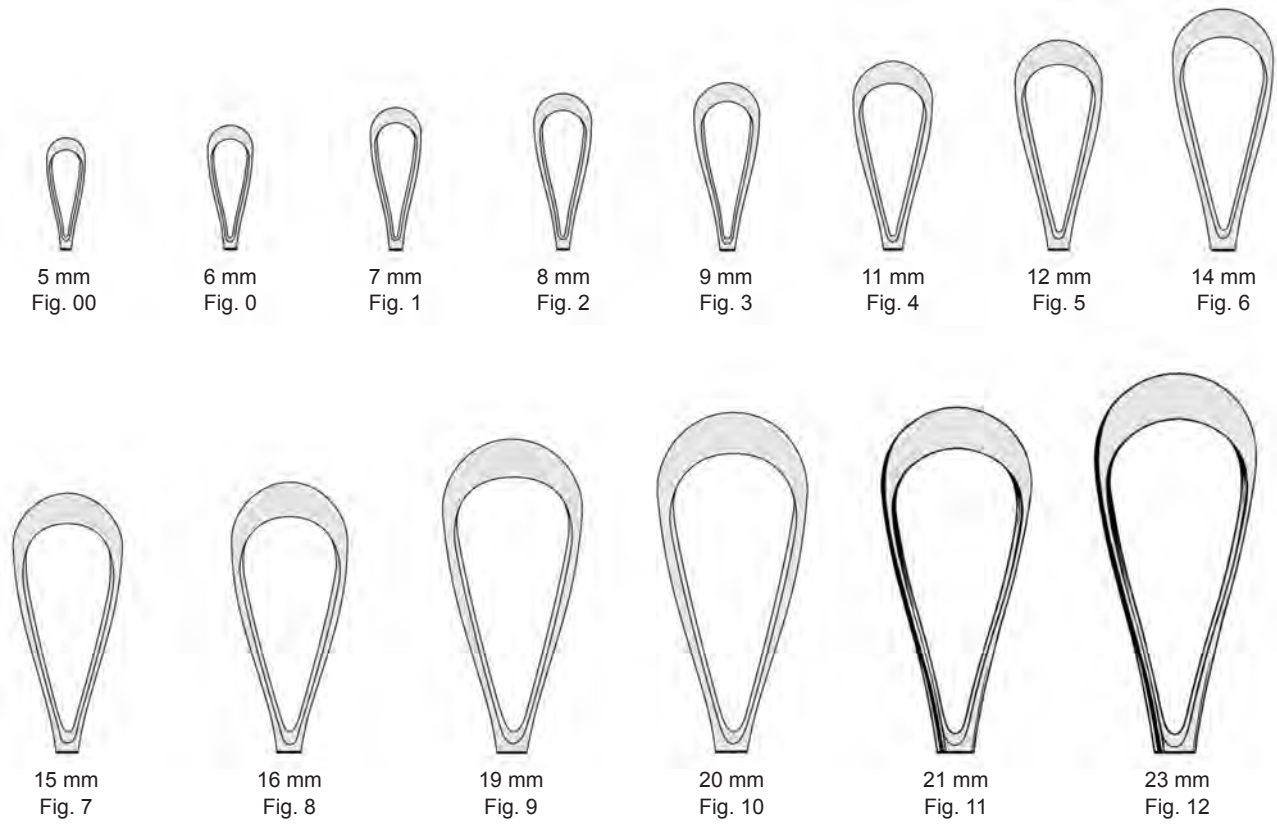


**DOYEN**  
19,0 cm, 7<sup>1</sup>/<sub>2</sub>"  
**180-588-01**



**DOYEN**  
17,0 cm, 6<sup>3</sup>/<sub>4</sub>"  
**180-588-02**

**Uterusküretten**  
**Uterine Curettes**  
**Curetas uterinas**  
**Curette uterine**



scharf, fest  
 sharp, rigid  
 cortantes, rígidas  
 acute, rigide

Fig. 00	180-700-05
Fig. 0	180-700-06
Fig. 1	180-700-07
Fig. 2	180-700-08
Fig. 3	180-700-09
Fig. 4	180-700-11
Fig. 5	180-700-12
Fig. 6	180-700-14
Fig. 7	180-700-15
Fig. 8	180-700-16
Fig. 9	180-700-19
Fig. 10	180-700-20
Fig. 11	180-700-21
Fig. 12	180-700-23

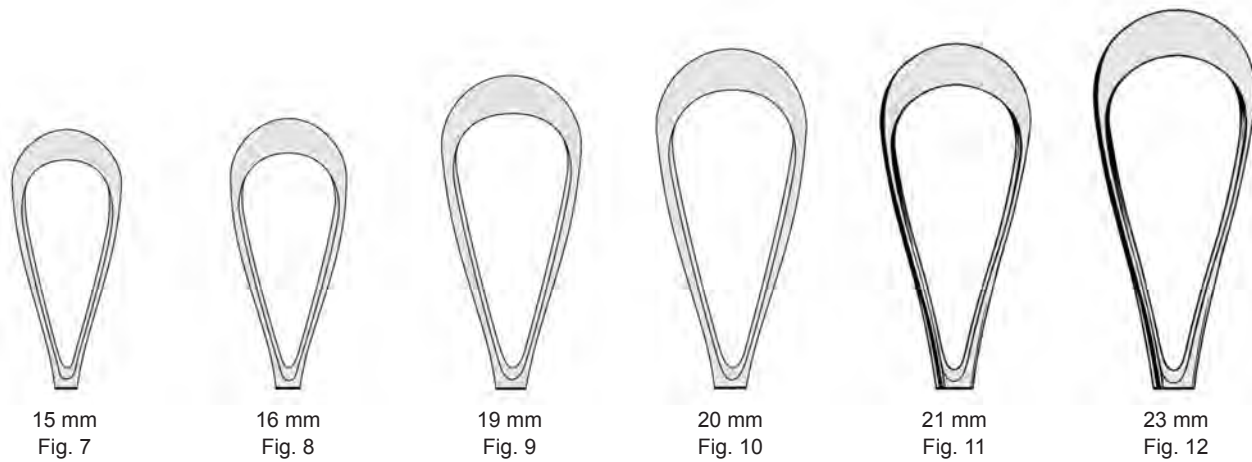
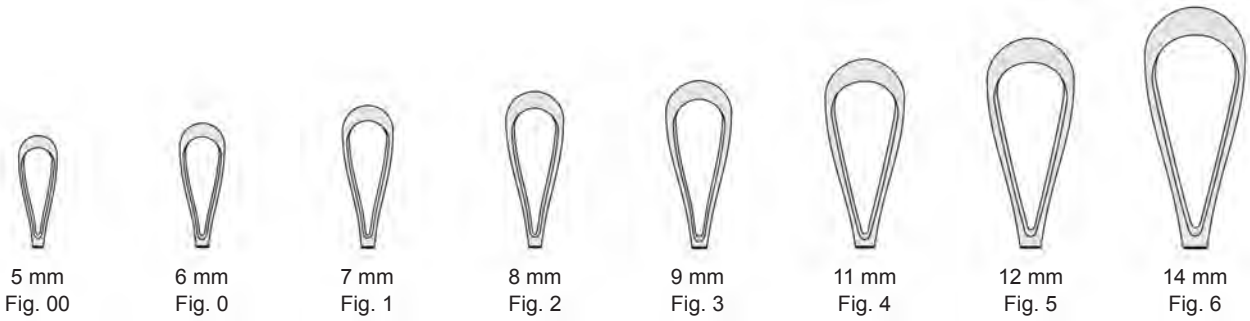
**RECAMIER**  
 26,0 cm, 10<sup>1</sup>/<sub>4</sub>"



scharf, biegsam  
 sharp, malleable  
 cortantes, maleable  
 acute, malleabile

Fig. 00	180-701-05
Fig. 0	180-701-06
Fig. 1	180-701-07
Fig. 2	180-701-08
Fig. 3	180-701-09
Fig. 4	180-701-11
Fig. 5	180-701-12
Fig. 6	180-701-14
Fig. 7	180-701-15
Fig. 8	180-701-16
Fig. 9	180-701-19
Fig. 10	180-701-20
Fig. 11	180-701-21
Fig. 12	180-701-23

**RECAMIER**  
 26,0 cm, 10<sup>1</sup>/<sub>4</sub>"



scharf, fest  
 sharp, rigid  
 cortantes, rígidas  
 acute, rigide

Fig. 00	180-702-05
Fig. 0	180-702-06
Fig. 1	180-702-07
Fig. 2	180-702-08
Fig. 3	180-702-09
Fig. 4	180-702-11
Fig. 5	180-702-12
Fig. 6	180-702-14
Fig. 7	180-702-15
Fig. 8	180-702-16
Fig. 9	180-702-19
Fig. 10	180-702-20
Fig. 11	180-702-21
Fig. 12	180-702-23

**SIMS**  
 26,0 cm, 10 1/4"

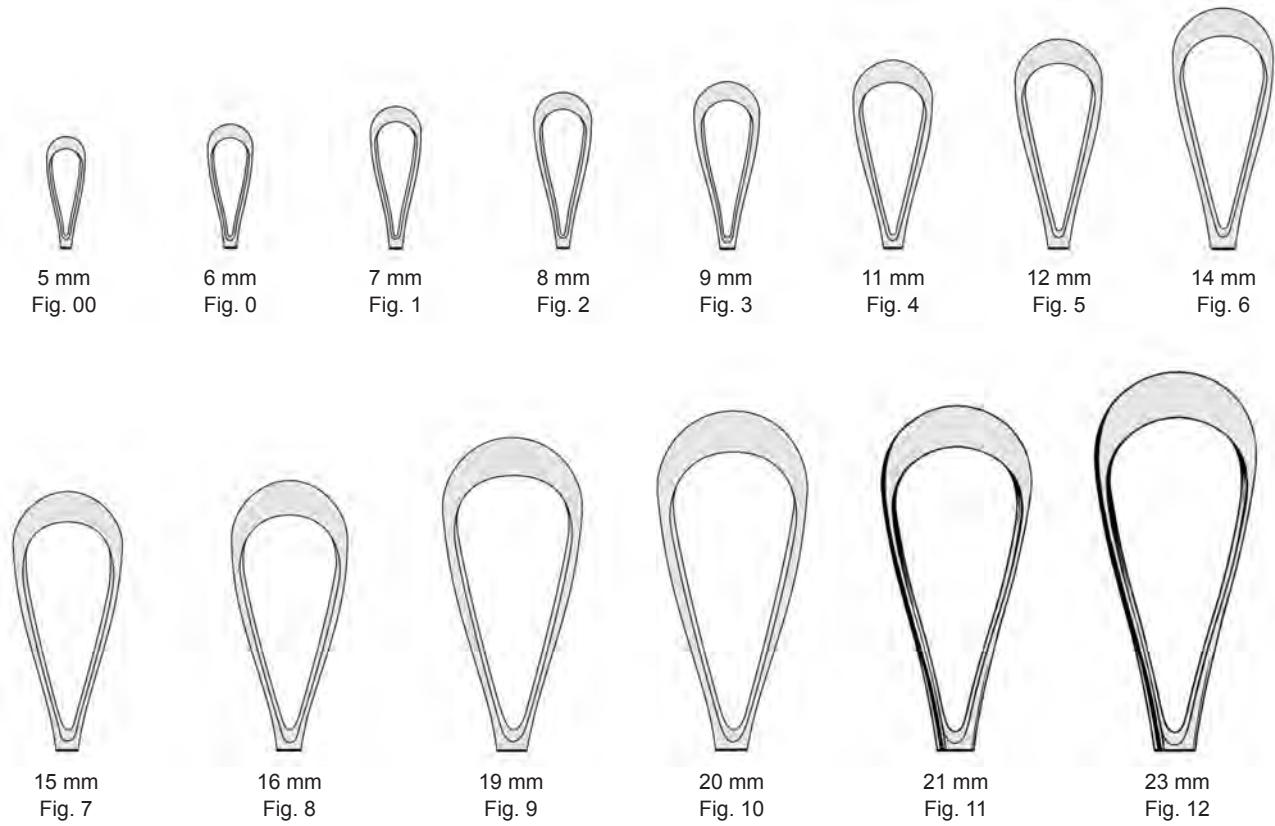


scharf, biegsam  
 sharp, malleable  
 cortantes, maleable  
 acute, malleabile

Fig. 00	180-703-05
Fig. 0	180-703-06
Fig. 1	180-703-07
Fig. 2	180-703-08
Fig. 3	180-703-09
Fig. 4	180-703-11
Fig. 5	180-703-12
Fig. 6	180-703-14
Fig. 7	180-703-15
Fig. 8	180-703-16
Fig. 9	180-703-19
Fig. 10	180-703-20
Fig. 11	180-703-21
Fig. 12	180-703-23

**SIMS**  
 26,0 cm, 10 1/4"

Uterusküretten  
 Uterine Curettes  
 Curetas uterinas  
 Curette uterine



scharf, fest  
 sharp, rigid  
 cortantes, rígidas  
 acute, rigide

Fig. 00	<b>180-710-05</b>
Fig. 0	<b>180-710-06</b>
Fig. 1	<b>180-710-07</b>
Fig. 2	<b>180-710-08</b>
Fig. 3	<b>180-710-09</b>
Fig. 4	<b>180-710-11</b>
Fig. 5	<b>180-710-12</b>
Fig. 6	<b>180-710-14</b>
Fig. 7	<b>180-710-15</b>
Fig. 8	<b>180-710-16</b>
Fig. 9	<b>180-710-19</b>
Fig. 10	<b>180-710-20</b>
Fig. 11	<b>180-710-21</b>
Fig. 12	<b>180-710-23</b>

**RECAMIER**  
 31,0 cm, 12<sup>1</sup>/<sub>4</sub>"



scharf, biegsam  
 sharp, malleable  
 cortantes, maleable  
 acute, malleabile

Fig. 00	<b>180-711-05</b>
Fig. 0	<b>180-711-06</b>
Fig. 1	<b>180-711-07</b>
Fig. 2	<b>180-711-08</b>
Fig. 3	<b>180-711-09</b>
Fig. 4	<b>180-711-11</b>
Fig. 5	<b>180-711-12</b>
Fig. 6	<b>180-711-14</b>
Fig. 7	<b>180-711-15</b>
Fig. 8	<b>180-711-16</b>
Fig. 9	<b>180-711-19</b>
Fig. 10	<b>180-711-20</b>
Fig. 11	<b>180-711-21</b>
Fig. 12	<b>180-711-23</b>

**RECAMIER**  
 31,0 cm, 12<sup>1</sup>/<sub>4</sub>"



5 mm  
Fig. 00

6 mm  
Fig. 0

7 mm  
Fig. 1

8 mm  
Fig. 2

9 mm  
Fig. 3

11 mm  
Fig. 4

12 mm  
Fig. 5

14 mm  
Fig. 6

15 mm  
Fig. 7

16 mm  
Fig. 8

19 mm  
Fig. 9

20 mm  
Fig. 10

21 mm  
Fig. 11

23 mm  
Fig. 12



scharf, fest  
 sharp, rigid  
 cortantes, rígidas  
 acute, rigide

Fig. 00	<b>180-712-05</b>
Fig. 0	<b>180-712-06</b>
Fig. 1	<b>180-712-07</b>
Fig. 2	<b>180-712-08</b>
Fig. 3	<b>180-712-09</b>
Fig. 4	<b>180-712-11</b>
Fig. 5	<b>180-712-12</b>
Fig. 6	<b>180-712-14</b>
Fig. 7	<b>180-712-15</b>
Fig. 8	<b>180-712-16</b>
Fig. 9	<b>180-712-19</b>
Fig. 10	<b>180-712-20</b>
Fig. 11	<b>180-712-21</b>
Fig. 12	<b>180-712-23</b>

**SIMS**  
 31,0 cm, 12 1/4"

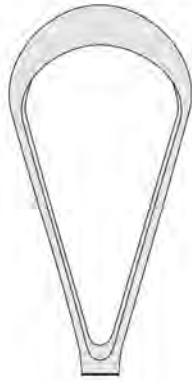


scharf, biegsam  
 sharp, malleable  
 cortantes, maleable  
 acute, malleabile

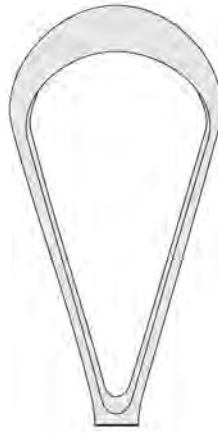
Fig. 00	<b>180-713-05</b>
Fig. 0	<b>180-713-06</b>
Fig. 1	<b>180-713-07</b>
Fig. 2	<b>180-713-08</b>
Fig. 3	<b>180-713-09</b>
Fig. 4	<b>180-713-11</b>
Fig. 5	<b>180-713-12</b>
Fig. 6	<b>180-713-14</b>
Fig. 7	<b>180-713-15</b>
Fig. 8	<b>180-713-16</b>
Fig. 9	<b>180-713-19</b>
Fig. 10	<b>180-713-20</b>
Fig. 11	<b>180-713-21</b>
Fig. 12	<b>180-713-23</b>

**SIMS**  
 31,0 cm, 12 1/4"

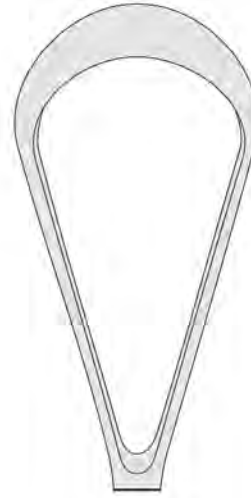
Uterusküretten  
 Uterine Curettes  
 Curetas uterinas  
 Curette uterine



30 mm  
 Fig. 1



35 mm  
 Fig. 2



40 mm  
 Fig. 3



scharf, fest  
 sharp, rigid  
 cortantes, rígidas  
 acute, rigide

Fig. 1 **180-720-30**  
 Fig. 2 **180-720-35**  
 Fig. 3 **180-720-40**

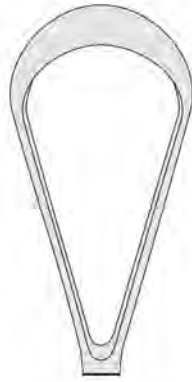
**SIMS**  
 31,0 cm, 12<sup>1</sup>/<sub>4</sub>"



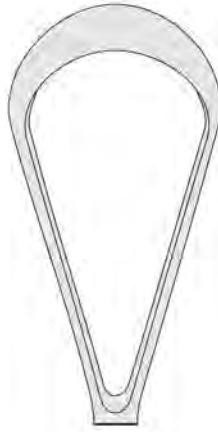
scharf, biegsam  
 sharp, malleable  
 cortantes, maleable  
 acute, malleabile

Fig. 1 **180-721-30**  
 Fig. 2 **180-721-35**  
 Fig. 3 **180-721-40**

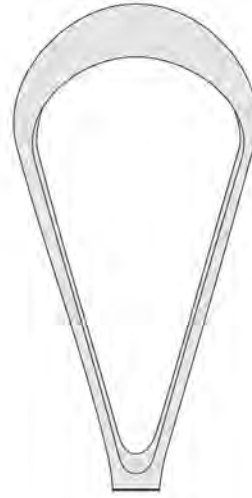
**SIMS**  
 31,0 cm, 12<sup>1</sup>/<sub>4</sub>"



30 mm  
Fig. 1



35 mm  
Fig. 2



40 mm  
Fig. 3



scharf, fest  
sharp, rigid  
cortantes, rígidas  
acute, rigide

Fig. 1 **180-722-30**  
Fig. 2 **180-722-35**  
Fig. 3 **180-722-40**

**BUMM**  
31,0 cm, 12 1/4"



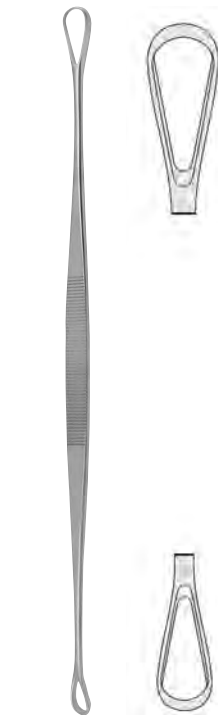
scharf, biegsam  
sharp, malleable  
cortantes, maleable  
acute, malleabile

Fig. 1 **180-723-30**  
Fig. 2 **180-723-35**  
Fig. 3 **180-723-40**

**BUMM**  
31,0 cm, 12 1/4"



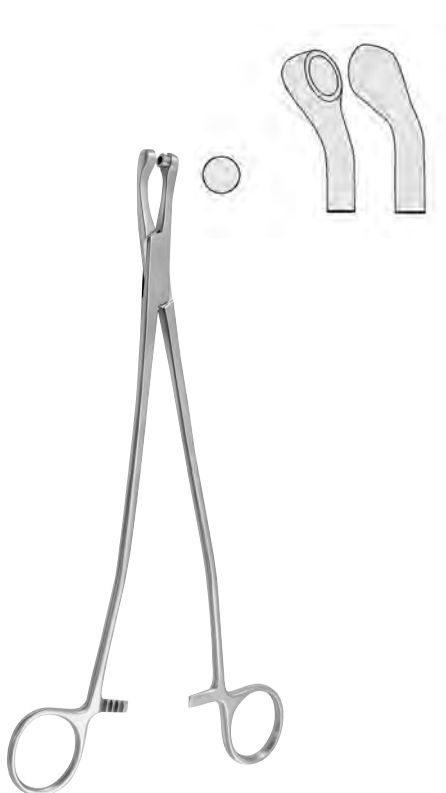
**Uteruslöffel, Uterus-Biopsiezangen**  
**Uterine Scoopes, Cervical Biopsy and Specimen Forceps**  
**Cucharillas uterinas, Pinzas saca-bocados para biopsia**  
**Curette uterine, Pinze per la biopsia cervicale e da prelievo**



**BLAKE**  
 27,0 cm, 10<sup>5</sup>/<sub>8</sub>"  
**180-750-27**



**SIMON**  
 25,0 cm, 9<sup>3</sup>/<sub>4</sub>"



**THOMS-GAYLOR**  
 22,0 cm, 8<sup>5</sup>/<sub>8</sub>" **180-680-22**  
 24,0 cm, 9<sup>1</sup>/<sub>2</sub>" **180-680-24**



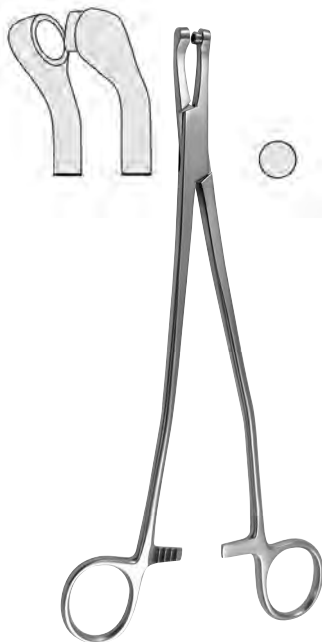
**SCHUBERT**  
 21,0 cm, 8<sup>1</sup>/<sub>4</sub>" **180-682-21**  
 29,0 cm, 11<sup>1</sup>/<sub>2</sub>" **180-682-29**



**SCHUMACHER-VAN DOREN**  
 24,0 cm, 9<sup>1</sup>/<sub>2</sub>"  
**180-684-24**



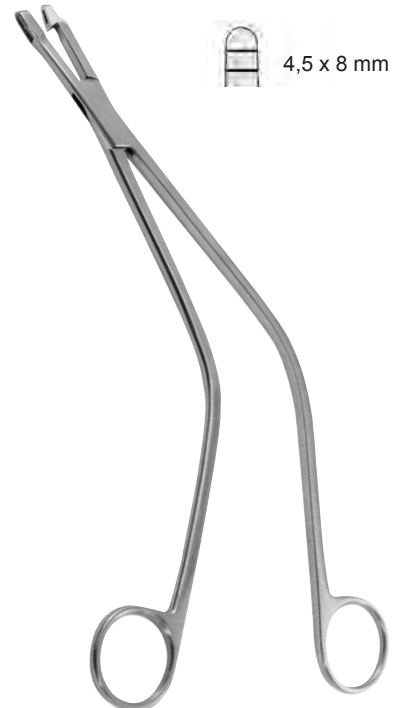
**Uterus-Biopsiezangen**  
**Cervical Biopsy and Specimen Forceps**  
**Pinzas saca-bocados para biopsia**  
**Pinze per la biopsia cervicale e da prelievo**



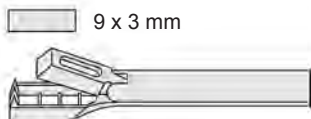
**THOMS-GAYLOR**  
24,0 cm, 9 1/2"  
180-686-24



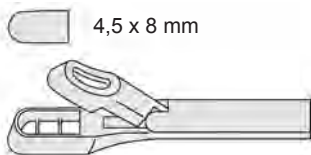
**FAURE**  
21,0 cm, 8 1/4"  
180-688-21



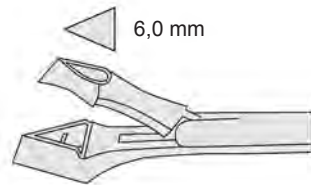
**SCHUBERT**  
26,0 cm, 10 1/4"  
180-690-26



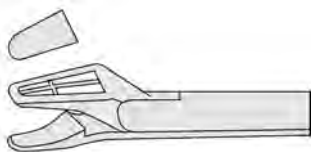
**KEVORKIAN**  
25,0 cm, 10"  
180-602-25



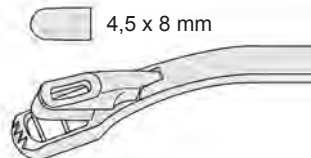
**EPPENDORFER**  
20,0 cm, 8"  
180-604-20



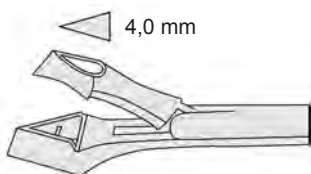
**SCHUMACHER**  
24,0 cm, 9 1/2"  
180-610-06



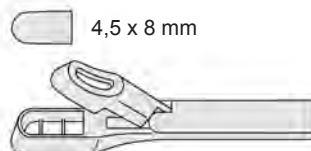
**ALEXANDER**  
28,0 cm, 11"  
180-608-28



**WITTNER**  
23,0 cm, 9"  
180-615-23

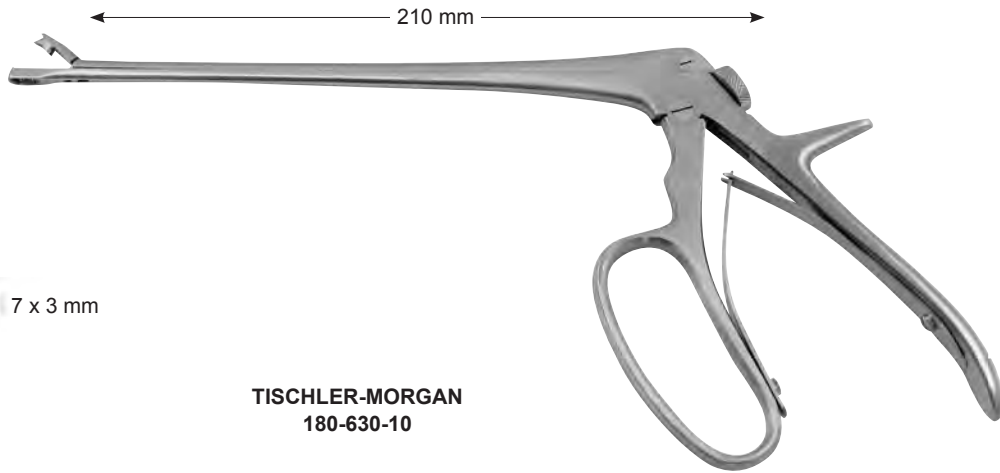
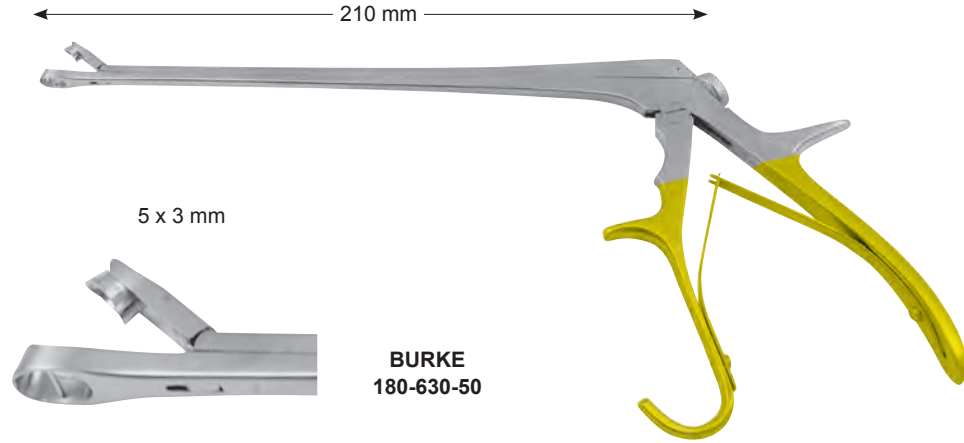


**SCHUMACHER**  
24,0 cm, 9 1/2"  
180-610-04



**WITTNER**  
23,0 cm, 9"  
180-614-23

Uterus-Biopsiezangen  
 Cervical Biopsy and Specimen Forceps  
 Pinzas saca-bocados para biopsia  
 Pinze per la biopsia cervicale e da prelievo



2,3 x 4 mm

**MINI-TOWNSEND**  
180-630-12

9 x 3 mm

**TISCHLER-KEVORKIAN**  
180-630-41

2,3 x 4 mm

**BABY-TISCHLER**  
180-630-14

9 x 3 mm

**KEVORKIAN-PACIFIC**  
180-630-40



**WRIGLEY**  
28,0 cm, 11"  
181-056-28



**SIMPSON**  
30,0 cm, 11<sup>3</sup>/<sub>4</sub>"  
181-034-30



**SIMPSON-BRAUN**  
33,0 cm, 13"  
181-036-33



**SIMPSON-BRAUN**  
36,0 cm, 14<sup>1</sup>/<sub>8</sub>"  
181-036-36



**SIMPSON-LUIKART**  
36,0 cm, 14<sup>1</sup>/<sub>8</sub>"  
181-046-36



**DE LEE**  
30,0 cm, 11<sup>3</sup>/<sub>4</sub>"  
181-058-30



**DE LEE**  
36,0 cm, 14<sup>1</sup>/<sub>8</sub>"  
181-058-36



**DE LEE**  
38,0 cm, 15<sup>3</sup>/<sub>8</sub>"  
181-058-38



**MC LEAN**  
 36,0 cm, 14<sup>1</sup>/<sub>8</sub>"  
 181-044-36



**KIELAND**  
 41,0 cm, 16"  
 181-052-41



**KIELAND-LUIKART**  
 40,0 cm, 15<sup>3</sup>/<sub>4</sub>"  
 181-054-40



**PIPER**  
 44,0 cm, 17<sup>1</sup>/<sub>4</sub>"  
 181-060-44



**ELLIOT**  
 32,0 cm, 12<sup>1</sup>/<sub>2</sub>"  
 181-080-32



**ELLIOT**  
 38,0 cm, 15"  
 181-080-38



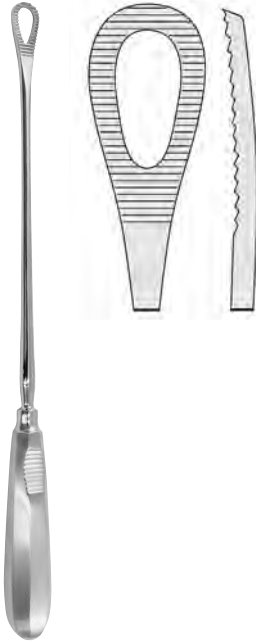
**NAEGELE**  
 36,0 cm, 14<sup>1</sup>/<sub>8</sub>"  
 181-084-36



**NAEGELE**  
 40,0 cm, 15<sup>3</sup>/<sub>4</sub>"  
 181-084-40



**GREEN-ARMYTAGE**  
21,0 cm, 8<sup>1</sup>/<sub>4</sub>"  
181-200-21



**PESTALOZZA**  
30,0 cm, 11<sup>3</sup>/<sub>4</sub>"  
181-252-30



**SAENGER**  
27,0 cm, 10<sup>5</sup>/<sub>8</sub>"  
181-260-27



**SAENGER**  
27,0 cm, 10<sup>5</sup>/<sub>8</sub>"  
181-261-27



**WINTER**  
28,0 cm, 11"



Fig. 1  
181-244-01



Fig. 2  
181-244-02



Fig. 3  
181-244-03



Fig. 1  
181-245-01



Fig. 2  
181-245-02



Fig. 3  
181-245-03

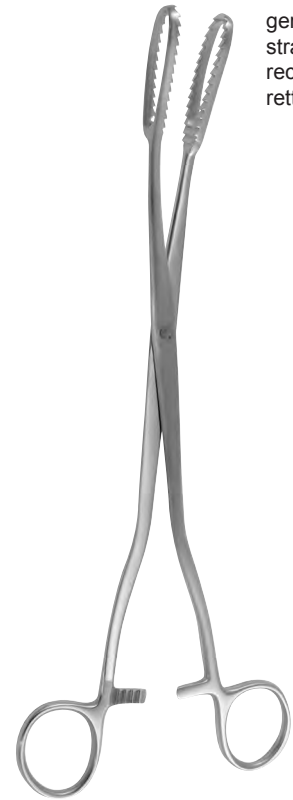
Plazentar- und Abortuszangen  
 Placenta and Ovum Forceps  
 Pinzas para aborto y placenta  
 Pinze per placenta e per ovaie



**WALLICH**  
 42,0 cm, 16<sup>1</sup>/<sub>2</sub>"  
 181-300-42



**MARTIN**  
 34,0 cm, 13<sup>3</sup>/<sub>8</sub>"  
 181-600-34



gerade  
 straight  
 recto  
 retto

**BIERER**  
 33,0 cm, 13"  
 58-1236-01



gerade  
 straight  
 recto  
 retto

**BIERER**  
 33,0 cm, 13"  
 181-236-02



gebogen  
 curved  
 curvo  
 curvo

**BIERER**  
 33,0 cm, 13"  
 181-237-01



gebogen  
 curved  
 curvo  
 curvo

**BIERER**  
 33,0 cm, 13"  
 181-237-02

**Vorbereitung, Dermatologie**  
**Preparation, Dermatology**  
**Preparación, Dermatología**  
**Preparazione, Dermatalogia**



Hautstanzen, Nagel Instrumente  
 Dermal Punches, Nail Instruments  
 Trépanos cutáneos, Instrumentos para uñas  
 Trapani dermatici, Strumenti per unghie

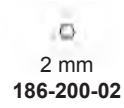


**PIFFARD**  
 14,0 cm, 5<sup>3</sup>/<sub>4</sub>"

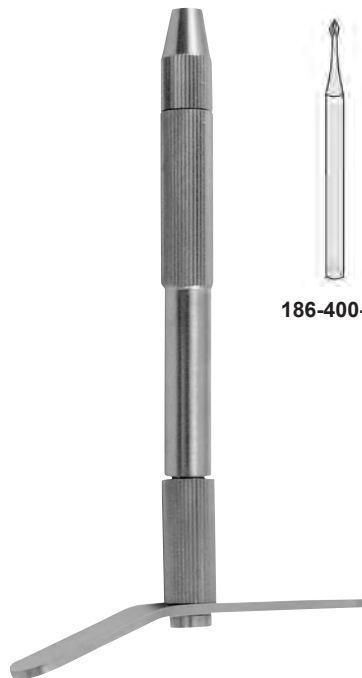
Lupusküretten  
 Lupus cures  
 Curetas para lupus  
 Raschiatoio per lupus



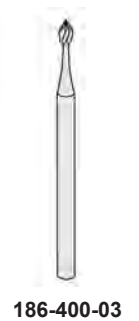
**KEYES**  
 12,0 cm, 4<sup>3</sup>/<sub>4</sub>"



**KEYES**  
 12,0 cm, 4<sup>3</sup>/<sub>4</sub>"  
**186-210-00**



**186-400-00**  
 komplett, complete,  
 completo, completo,





**Komedonenquetscher  
 Comedo Extractors  
 Saca-comedones  
 Tiracomedoni**



**UNNA**  
 14,0 cm, 5<sup>3</sup>/<sub>4</sub>"  
 186-000-14



**UNNA**  
 14,0 cm, 5<sup>3</sup>/<sub>4</sub>"  
 186-002-14



**SAALFELD**  
 10,0 cm, 4"  
 186-010-10



**SAALFELD**  
 14,0 cm, 5<sup>3</sup>/<sub>4</sub>"  
 186-012-14



**SCHAMBERG**  
 10,0 cm, 4"  
 186-020-10



**WALTON**  
 14,0 cm, 5<sup>3</sup>/<sub>4</sub>"  
 186-030-14



**FOX**  
 14,0 cm, 5<sup>3</sup>/<sub>4</sub>"



3 mm  
 186-100-03



4 mm  
 186-100-04



5 mm  
 186-100-05



6 mm  
 186-100-06

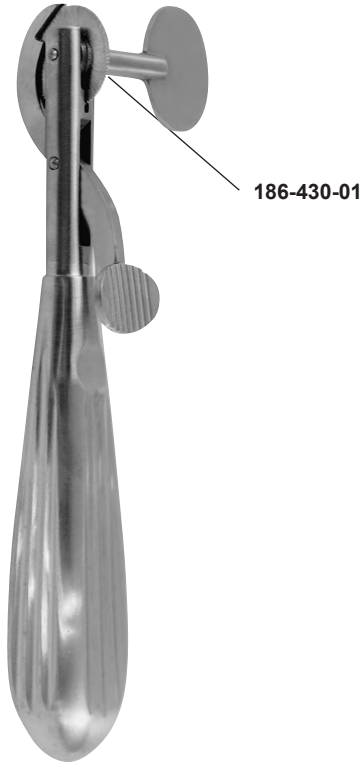
Lupusküretten  
 Lupus cures  
 Cures para lupus  
 Raschiatoio per lupus

**Nagel Instrumente**  
**Nail Instruments**  
**Instrumentos para uñas**  
**Strumenti per unghie**



186-420-01

17,0 cm, 6<sup>3</sup>/<sub>4</sub>"  
**186-420-17**



186-430-01

**WALTON**  
 16,0 cm, 6<sup>1</sup>/<sub>4</sub>"  
**186-430-16**



**RADOLF**  
 13,5 cm, 5<sup>3</sup>/<sub>8</sub>"  
**186-500-13**



13,5 cm, 5<sup>3</sup>/<sub>8</sub>"  
**186-510-13**



13,0 cm, 5"  
**186-600-13**



186-610-01



186-610-02

14,0 cm, 5<sup>1</sup>/<sub>2</sub>"

**Knochenchirurgie**  
**Bone Surgery**  
**Cirurgía ósea**  
**Chirurgia ossea**

Scharfe Löffel  
 Bone Curettes  
 Cucharillas cortantes  
 Curetta per ossa



**SCHEDI**  
 17,0 cm, 6<sup>3</sup>/<sub>4</sub>"

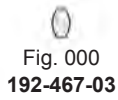


Fig. 000  
 192-467-03

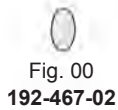


Fig. 00  
 192-467-02



Fig. 0  
 192-467-01



Fig. 1  
 192-467-11



Fig. 2  
 192-467-12

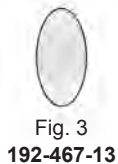


Fig. 3  
 192-467-13



Fig. 4  
 192-467-14



**VOLKMANN**  
 17,0 cm, 6<sup>3</sup>/<sub>4</sub>"



Fig. 0000  
 192-469-04



Fig. 000  
 192-469-03



Fig. 00  
 192-469-02



Fig. 0  
 192-469-01



Fig. 1  
 192-469-11



Fig. 2  
 192-469-12

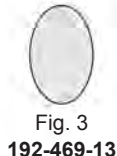


Fig. 3  
 192-469-13

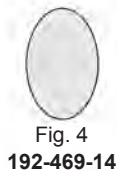


Fig. 4  
 192-469-14



Fig. 5  
 192-469-15



Fig. 6  
 192-469-16



**BRUNS**  
 17,0 cm, 6<sup>3</sup>/<sub>4</sub>"

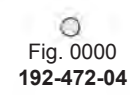


Fig. 0000  
 192-472-04



Fig. 000  
 192-472-03



Fig. 00  
 192-472-02



Fig. 0  
 192-472-01



Fig. 1  
 192-472-11



Fig. 2  
 192-472-12



Fig. 3  
 192-472-13



Fig. 4  
 192-472-14



Fig. 5  
 192-472-15



Fig. 6  
 192-472-16




Fig. 00000  
**192-448-04**



**LEMPERT**  
21,5 cm, 8½"




Fig. 0000  
**192-448-03**



Fig. 000  
**192-448-02**



Fig. 00  
**192-448-01**




Fig. 0  
**192-448-00**



**HALLE**  
21,0 cm, 8¼"



Fig. 00  
**192-452-02**



Fig. 0  
**192-452-01**




Fig. 1  
**192-452-11**



**DAUBENSPECK**  
20,0 cm, 8"



Fig. 00  
**192-487-02**




Fig. 0  
**192-487-01**




Fig. 1  
**192-487-11**



Fig. 2  
**192-487-12**

Scharfe Löffel  
 Bone Curettes  
 Cucharillas cortantes  
 Curetta per ossa



**WILLIGER**  
 17,0 cm, 6<sup>3</sup>/<sub>4</sub>"



Fig. 1  
**192-430-11**



Fig. 2  
**192-430-12**



**WILLIGER**  
 14,0 cm, 5<sup>1</sup>/<sub>2</sub>"



Fig. 0  
**192-406-00**



Fig. 1  
**192-406-01**

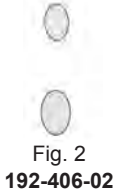


Fig. 2  
**192-406-02**



**MARTINI**  
 14,0 cm, 5<sup>1</sup>/<sub>2</sub>"  
**192-408-00**



Fig. 00/0  
**192-408-00**  
 14,0 cm, 5<sup>1</sup>/<sub>2</sub>"



Fig. 0/1  
**192-408-01**  
 14,0 cm, 5<sup>1</sup>/<sub>2</sub>"



Fig. 1/2  
**192-408-12**  
 14,0 cm, 5<sup>1</sup>/<sub>2</sub>"



**VOLKMANN**



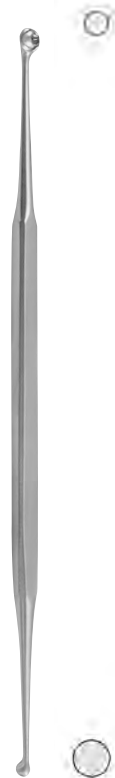
**192-414-13**  
 13,0 cm, 5"



**192-414-14**  
 14,0 cm, 5<sup>1</sup>/<sub>2</sub>"

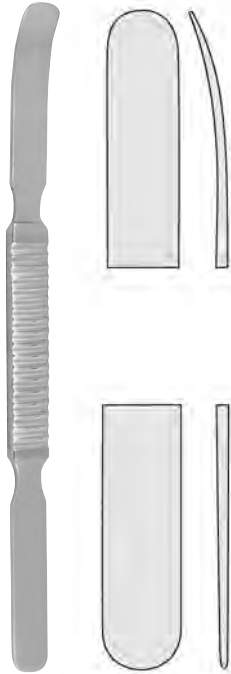


**192-414-17**  
 17,0 cm, 6<sup>3</sup>/<sub>4</sub>"



**JANSEN**  
 16,0 cm, 6<sup>1</sup>/<sub>4</sub>"  
**192-410-16**

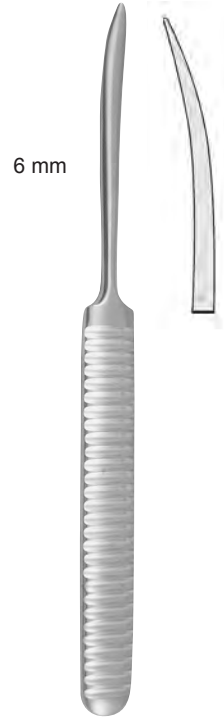




**WATSON-CHEYNE**  
17,5 cm, 6<sup>5</sup>/<sub>8</sub>"  
193-501-17



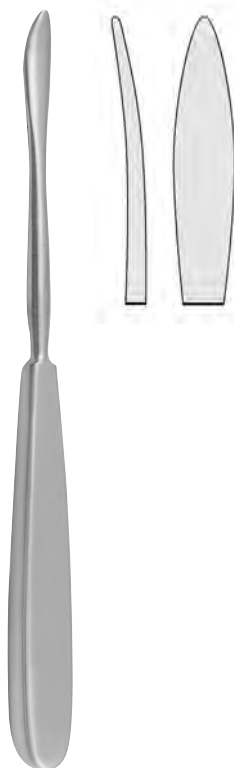
**MC DONALD**  
19,0 cm, 7<sup>1</sup>/<sub>2</sub>"  
193-440-19



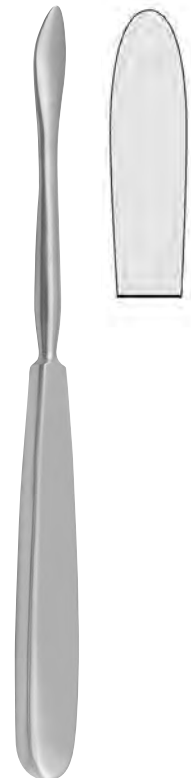
**WILLIGER**  
17,0 cm, 6<sup>3</sup>/<sub>4</sub>"  
193-512-17



**WILLIGER**  
16,0 cm, 6<sup>1</sup>/<sub>4</sub>"  
193-512-16



**LANGENBECK**  
20,0 cm, 8"  
193-520-08



**LANGENBECK**  
20,0 cm, 8"  
193-520-10



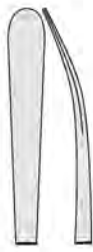
Raspatorien  
Raspatories  
Periostótomos  
Periostotomi



**ADSON**  
17,0 cm, 6<sup>3</sup>/<sub>4</sub>"



8 mm  
193-465-01



7 mm  
193-465-02



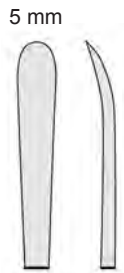
7 mm  
193-465-03



7 mm  
193-465-04



**KÖNIG**  
15,5 cm, 6"  
193-476-15



5 mm



**LAMBOTTE**  
21,0 cm, 8<sup>1</sup>/<sub>4</sub>"



10 mm  
193-477-10



15 mm  
193-477-15



20 mm  
193-477-20



25 mm  
193-477-25

12,5 mm

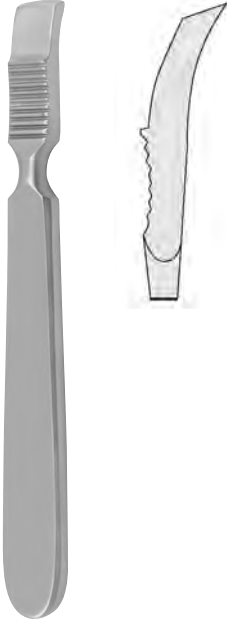


**FARABEUF**  
15,0 cm, 6"  
193-478-15





12,5 mm



**FARABEUF**  
15,0 cm, 6"  
193-479-15

16,0 mm



**LANGENBECK**  
19,0 cm, 7 1/2"  
193-472-19

15,0 mm



**SEDILLOT**  
21,0 cm, 8 1/4"  
193-488-21



4 mm **193-480-04**  
6 mm **193-480-06**  
8 mm **193-480-08**

**WILLIGER**  
16,0 cm, 6 1/4"



für Kinder  
for children  
para niños  
per bambini

**DOYEN**  
17,0 cm, 6 3/4"  
193-485-17



für Kinder  
for children  
para niños  
per bambini

**DOYEN**  
17,0 cm, 6 3/4"  
193-487-17



für Erwachsene  
for adults  
para adultos  
per adulti дп

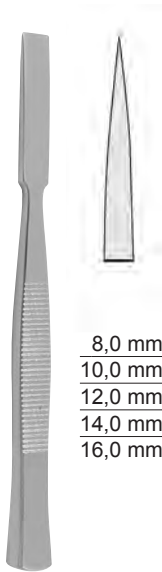
**DOYEN**  
17,0 cm, 6 3/4"  
193-481-17



für Erwachsene  
for adults  
para adultos  
per adulti

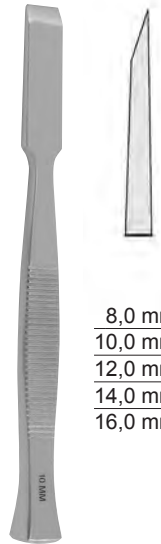
**DOYEN**  
17,0 cm, 6 3/4"  
193-483-17

Flachmeißel, Hohlmeißel, Osteotome  
 Chisels, Gouges, Osteotomes  
 Cinceles, Gubias, Osteótomos  
 Scalpelli, Sgorbie, Osteotomi



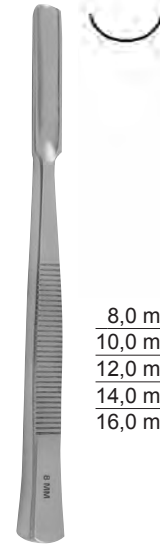
8,0 mm	<b>194-300-08</b>
10,0 mm	<b>194-300-10</b>
12,0 mm	<b>194-300-12</b>
14,0 mm	<b>194-300-14</b>
16,0 mm	<b>194-300-16</b>

13,5 cm, 5<sup>3</sup>/<sub>8</sub>"



8,0 mm	<b>194-301-08</b>
10,0 mm	<b>194-301-10</b>
12,0 mm	<b>194-301-12</b>
14,0 mm	<b>194-301-14</b>
16,0 mm	<b>194-301-16</b>

13,5 cm, 5<sup>3</sup>/<sub>8</sub>"



8,0 mm	<b>194-302-08</b>
10,0 mm	<b>194-302-10</b>
12,0 mm	<b>194-302-12</b>
14,0 mm	<b>194-302-14</b>
16,0 mm	<b>194-302-16</b>

13,5 cm, 5<sup>3</sup>/<sub>8</sub>"



3,0 mm	<b>194-334-03</b>
4,0 mm	<b>194-334-04</b>
5,0 mm	<b>194-334-05</b>
6,0 mm	<b>194-334-06</b>

**PARTSCH**  
13,5 cm, 5<sup>3</sup>/<sub>8</sub>"



3,0 mm	<b>194-336-03</b>
4,0 mm	<b>194-336-04</b>
5,0 mm	<b>194-336-05</b>
6,0 mm	<b>194-336-06</b>

**PARTSCH**  
13,5 cm, 5<sup>3</sup>/<sub>8</sub>"



10,0 mm	<b>194-361-10</b>
15,0 mm	<b>194-361-15</b>
20,0 mm	<b>194-361-20</b>
25,0 mm	<b>194-361-25</b>

**STILLE**  
20,0 cm, 8"



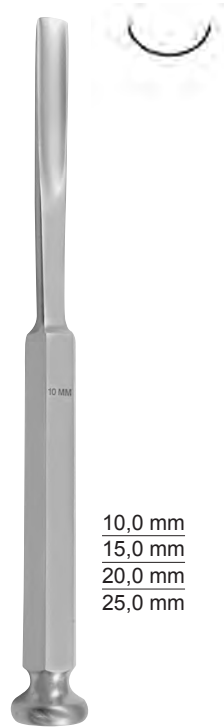
**Flachmeißel, Hohlmeißel, Osteotome  
Chisels, Gouges, Osteotomes  
Cinceles, Gubias, Osteótomos  
Scalpelli, Sgorbie, Osteotomi**



10,0 mm  
15,0 mm  
20,0 mm  
25,0 mm

**194-360-10**  
**194-360-15**  
**194-360-20**  
**194-360-25**

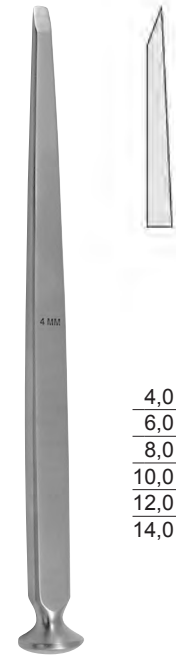
**STILLE**  
20,0 cm, 8"



10,0 mm  
15,0 mm  
20,0 mm  
25,0 mm

**194-362-10**  
**194-362-15**  
**194-362-20**  
**194-362-25**

**STILLE**  
20,0 cm, 8"



4,0 mm  
6,0 mm  
8,0 mm  
10,0 mm  
12,0 mm  
14,0 mm

**194-318-04**  
**194-318-06**  
**194-318-08**  
**194-318-10**  
**194-318-12**  
**194-318-14**

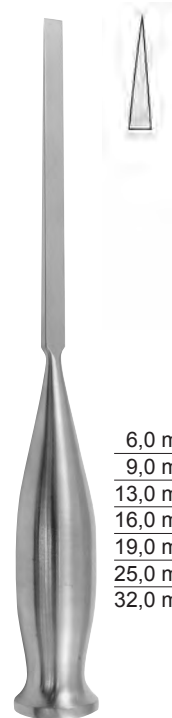
**ALEXANDER**  
18,0 cm, 7"



4,0 mm  
6,0 mm  
8,0 mm  
10,0 mm  
12,0 mm  
14,0 mm

**194-319-04**  
**194-319-06**  
**194-319-08**  
**194-319-10**  
**194-319-12**  
**194-319-14**

**ALEXANDER**  
18,0 cm, 7"



6,0 mm  
9,0 mm  
13,0 mm  
16,0 mm  
19,0 mm  
25,0 mm  
32,0 mm

**194-350-06**  
**194-350-09**  
**194-350-13**  
**194-350-16**  
**194-350-19**  
**194-350-25**  
**194-350-32**

**SMITH-PETERSEN**  
20,0 cm, 8"



6,0 mm  
9,0 mm  
13,0 mm  
16,0 mm  
19,0 mm  
25,0 mm  
32,0 mm

**194-351-06**  
**194-351-09**  
**194-351-13**  
**194-351-16**  
**194-351-19**  
**194-351-25**  
**194-351-32**

**SMITH-PETERSEN**  
20,0 cm, 8"

Flachmeißel, Hohlmeißel, Osteotome, Hämmer  
 Chisels, Gouges, Osteotomes, Mallets  
 Cinceles, Gubias, Osteótomos, Martillos  
 Scalpelli, Sgorbie, Osteotomi, Martelli



9,0 mm  
 14,0 mm  
 16,0 mm  
 19,0 mm  
 25,0 mm

**194-352-09**  
**194-352-14**  
**194-352-16**  
**194-352-19**  
**194-352-25**

**SMITH-PETERSEN**  
 20,0 cm, 8"



9,0 mm  
 14,0 mm  
 16,0 mm  
 19,0 mm  
 25,0 mm

**194-353-09**  
**194-353-14**  
**194-353-16**  
**194-353-19**  
**194-353-25**

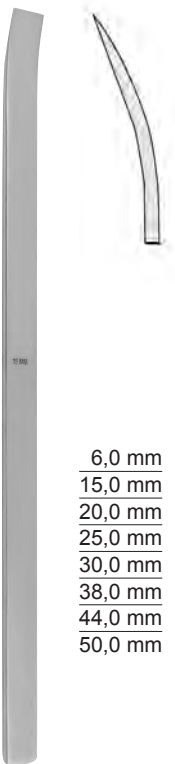
**SMITH-PETERSEN**  
 20,0 cm, 8"



6,0 mm  
 15,0 mm  
 20,0 mm  
 25,0 mm  
 30,0 mm  
 38,0 mm  
 44,0 mm  
 50,0 mm

**194-450-06**  
**194-450-15**  
**194-450-20**  
**194-450-25**  
**194-450-30**  
**194-450-38**  
**194-450-44**  
**194-450-50**

**LAMBOTTE**  
 24,0 cm, 9 1/2"



6,0 mm  
 15,0 mm  
 20,0 mm  
 25,0 mm  
 30,0 mm  
 38,0 mm  
 44,0 mm  
 50,0 mm

**194-451-06**  
**194-451-15**  
**194-451-20**  
**194-451-25**  
**194-451-30**  
**194-451-38**  
**194-451-44**  
**194-451-50**

**LAMBOTTE**  
 24,0 cm, 9 1/2"

Ø 30 mm  
 220 g



**COLLIN**  
 20,0 cm, 8"  
**191-132-20**

Ø 22 mm  
 200 g



**PARTSCH**  
 18,0 cm, 7"  
**191-145-18**

mit Bleifüllung  
 lead filled head  
 cabezal relleno de plomo  
 testa di piombo

Ø 45 mm  
 300 g



**BERGMANN**  
 24,0 cm, 9 1/2"  
**191-201-24**

**Sterilisation**  
**Sterilization**  
**Esterilización**  
**Sterilizzazione**

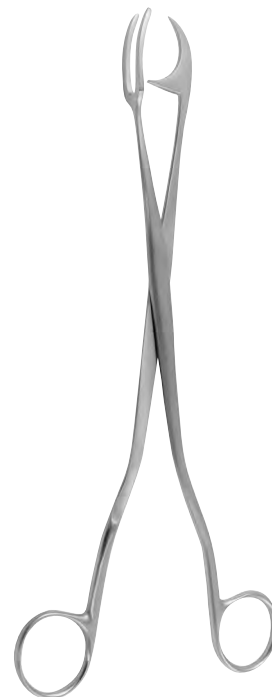
**Sterilisierzangen**  
**Sterilizing Forceps**  
**Pinzas para esterilización**  
**Pinze per sterilizzazione**



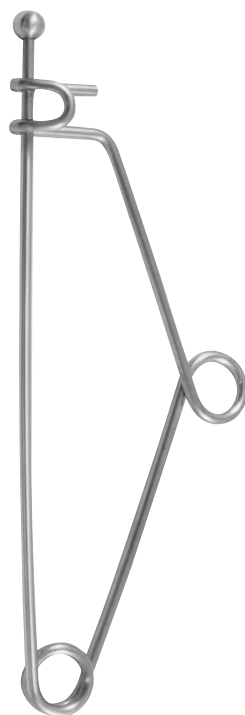
20,0 cm, 8"  
250-160-20



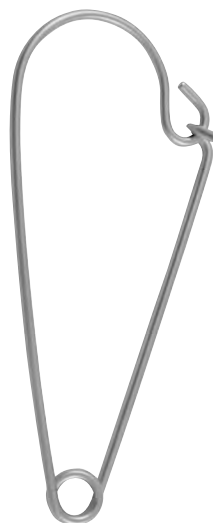
**CHEATTLE**  
27,0 cm, 10<sup>5</sup>/<sub>8</sub>"  
250-163-27



**ROGGE**  
23,0 cm, 9"  
250-164-23



**MAYO**  
14,0 cm, 5<sup>1</sup>/<sub>2</sub>"  
250-151-14



**BUNT**  
12,0 cm, 4<sup>3</sup>/<sub>4</sub>"  
250-154-12



Ø 75 x 130 mm	<b>250-142-06</b>
Ø 75 x 175 mm	<b>250-142-07</b>
Ø 100 x 175 mm	<b>250-142-08</b>
Ø 100 x 200 mm	<b>250-142-09</b>



Ø 40,0 mm	<b>250-130-04</b>
Ø 60,0 mm	<b>250-130-06</b>
Ø 80,0 mm	<b>250-130-08</b>
Ø 100,0 mm	<b>250-130-10</b>
Ø 120,0 mm	<b>250-130-12</b>
Ø 150,0 mm	<b>250-130-15</b>



165 x 55 mm	0,75 l	<b>250-133-00</b>
175 x 70 mm	1,00 l	<b>250-133-10</b>
225 x 100 mm	2,00 l	<b>250-133-20</b>
240 x 95 mm	2,75 l	<b>250-133-30</b>
260 x 120 mm	4,00 l	<b>250-133-40</b>
290 x 100 mm	5,00 l	<b>250-133-50</b>
315 x 150 mm	5,50 l	<b>250-133-60</b>
325 x 135 mm	8,00 l	<b>250-133-70</b>
360 x 165 mm	12,00 l	<b>250-133-80</b>
415 x 150 mm	14,00 l	<b>250-133-90</b>



170 mm	<b>250-140-17</b>
250 mm	<b>250-140-25</b>
275 mm	<b>250-140-27</b>



Schalen  
Trays  
Bandejas  
Bacinelle



**250-300-00**  
Ø 65 x 17 mm  
Außen- und Innendose  
Exterior and interior box  
Caja exterior e interior  
Scatola esterna es interiore

**250-300-01**  
Ø 62 x 13 mm  
Innendose allein  
Interior box only  
Caja interior, suelta  
Scatola interiore sola



200 x 150 x 25 mm	<b>250-200-01</b>
260 x 180 x 30 mm	<b>250-200-02</b>
300 x 220 x 30 mm	<b>250-200-03</b>
350 x 220 x 40 mm	<b>250-200-04</b>
220 x 170 x 50 mm	<b>250-200-05</b>
280 x 200 x 50 mm	<b>250-200-06</b>
320 x 240 x 50 mm	<b>250-200-07</b>
370 x 270 x 50 mm	<b>250-200-08</b>
420 x 320 x 50 mm	<b>250-200-09</b>



25 ccm  
**250-310-25**



50 ccm  
**250-310-50**



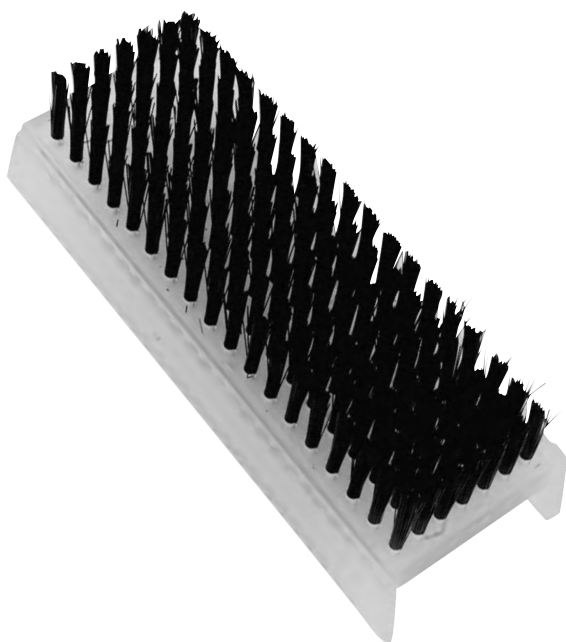
**IZIAL DENTAL SURGICAL**  
Manufacturer And Exporter Of Surgical Dental & Manicure

**Bürstenspender**  
**Brush Dispensers**  
**Distribuidores de cepillos**  
**Distributori di spazzole**



Bürstenspender für 10 Bürsten  
Brush dispenser for 10 brushes  
Distribuidor de cepillos para 10 cepillos  
Distributore per 10 spazzole  
260 x 155 x 65 mm  
**250-800-01**

Bürstenspender für 20 Bürsten  
Brush dispenser for 20 brushes  
Distribuidor de cepillos para 20 cepillos  
Distributore per 20 spazzole  
270 x 240 x 65 mm  
**250-800-02**



**250-800-10**

mehr als 400x autoklavierbar  
more than 400 times autoclavable  
esterilizable màs de 400 veces en autoclave  
sterilizzabile piú di 400 volte in autoclave

Index nummerisch  
Index numerical

Index numerisch  
Index numerical

003-003-00	2	003-250-17	8	010-052-12	16	010-114-23	22
003-003-01	2	003-250-20	8	010-052-13	16	010-114-25	22
003-003-02	2	003-250-22	8	010-052-14	16	010-114-28	22
003-004-00	3	003-400-19	11	010-053-12	16	010-114-30	22
003-004-01	3	003-401-19	11	010-053-13	16	010-115-14	20
003-007-00	2	003-410-30	11	010-053-14	16	010-115-18	22
003-007-01	2	003-411-30	11	010-054-12	16	010-115-20	22
003-008-00	3	003-412-35	11	010-054-13	16	010-115-23	22
003-009-00	3	003-413-35	11	010-054-14	16	010-115-25	22
003-050-10	4	003-420-30	11	010-055-12	16	010-115-28	22
003-050-11	4	003-421-30	11	010-055-13	16	010-115-30	22
003-050-11S	4	003-422-30	10	010-055-14	16	010-120-14	22
003-050-12	4	010-000-10	14	010-070-13	17	010-120-18	22
003-050-12D	4	010-000-11	14	010-070-14	17	010-120-20	22
003-050-13	4	010-000-13	14	010-071-13	17	010-120-23	22
003-050-15	4	010-000-14	14	010-071-14	17	010-120-25	22
003-050-15C	4	010-000-15	14	010-072-13	17	010-120-28	22
003-050-18	5	010-000-16	14	010-072-14	17	010-120-30	22
003-050-19	5	010-000-17	14	010-073-13	17	010-121-14	22
003-050-20	5	010-000-18	14	010-073-14	17	010-121-18	23
003-050-21	5	010-000-20	14	010-074-13	18	010-121-20	23
003-050-22	5	010-001-10	14	010-074-14	18	010-121-23	23
003-050-23	5	010-001-11	14	010-075-13	18	010-121-25	23
003-050-24	5	010-001-13	14	010-075-14	18	010-121-28	23
003-050-25	5	010-001-14	14	010-100-14	18	010-121-30	23
003-060-10	6	010-001-15	14	010-100-17	18	010-124-18	23
003-060-12	6	010-001-16	14	010-100-23	18	010-124-20	23
003-060-14	6	010-001-17	14	010-100-28	18	010-124-23	23
003-060-16	6	010-001-18	14	010-101-14	18	010-124-25	23
003-060-18	6	010-001-20	14	010-101-17	18	010-124-28	23
003-066-01	6	010-002-10	14	010-101-23	18	010-124-30	23
003-066-02	6	010-002-11	14	010-101-28	18	010-125-18	23
003-066-03	6	010-002-13	14	010-102-15	19	010-125-20	23
003-066-04	6	010-002-14	14	010-102-17	19	010-125-23	23
003-066-05	6	010-002-15	14	010-102-19	19	010-125-25	23
003-066-06	6	010-002-16	14	010-102-21	19	010-125-28	23
003-070-01	7	010-002-17	14	010-103-15	19	010-125-30	23
003-070-02	7	010-002-18	14	010-103-17	19	010-127-18	24
003-070-03	7	010-002-20	14	010-103-19	19	010-127-20	24
003-070-04	7	010-003-10	14	010-103-21	19	010-127-23	24
003-070-05	7	010-003-11	14	010-104-17	19	010-129-18	24
003-070-06	7	010-003-13	14	010-105-17	19	010-129-20	24
003-070-07	7	010-003-14	14	010-110-11	20	010-129-23	24
003-070-08	7	010-003-15	14	010-110-14	20	010-137-14	24
003-070-09	7	010-003-16	14	010-110-18	21	010-139-17	24
003-070-10	7	010-003-17	14	010-110-20	21	010-140-10	25
003-076-01	7	010-003-18	14	010-110-23	21	010-140-16	25
003-076-02	7	010-003-20	14	010-110-25	21	010-140-21	25
003-076-03	7	010-004-10	15	010-110-28	21	010-141-10	25
003-076-04	7	010-004-11	15	010-110-30	21	010-141-16	25
003-076-05	7	010-004-13	15	010-111-11	20	010-141-21	25
003-076-06	7	010-004-14	15	010-111-14	20	010-160-17	25
003-076-07	7	010-004-15	15	010-111-18	21	010-161-17	25
003-076-08	7	010-004-16	15	010-111-20	21	010-200-12	26
003-076-09	7	010-004-17	15	010-111-23	21	010-200-15	26
003-078-15	7	010-004-18	15	010-111-25	21	010-200-18	26
003-078-16	7	010-004-20	15	010-111-28	21	010-200-20	26
003-080-13	8	010-005-10	15	010-111-30	21	010-201-12	26
003-080-16	8	010-005-11	15	010-112-18	21	010-201-15	26
003-080-19	8	010-005-13	15	010-112-20	21	010-201-18	26
003-080-22	8	010-005-14	15	010-112-23	21	010-201-20	26
003-080-28	8	010-005-15	15	010-112-25	21	010-210-15	26
003-082-16	8	010-005-16	15	010-112-28	21	010-210-18	26
003-082-19	8	010-005-17	15	010-112-30	21	010-211-15	26
003-082-22	8	010-005-18	15	010-113-14	20	010-211-18	26
003-105-55	10	010-005-20	15	010-113-18	21	010-211-20	26
003-110-65	10	010-009-13	19	010-113-20	21	010-211-23	26
003-150-11	9	010-050-12	15	010-113-23	21	010-211-25	26
003-150-14	9	010-050-13	15	010-113-25	21	010-217-19	27
003-150-17	9	010-050-14	15	010-113-28	21	010-217-25	27
003-180-16	9	010-051-12	15	010-113-30	21	010-220-15	27
003-180-20	9	010-051-13	15	010-114-18	22	010-221-15	27
003-180-24	9	010-051-14	15	010-114-20	22	010-224-14	27

010-225-14	27	010-540-45	36	010-701-20	43	011-112-14	48
010-228-14	27	010-540-60	36	010-703-20	43	011-112-18	49
010-229-14	27	010-541-25	36	010-706-10	43	011-112-20	49
010-230-12	28	010-541-45	36	010-707-13	43	011-112-23	49
010-231-12	28	010-541-60	36	010-707-16	43	011-112-25	49
010-234-12	28	010-542-25	36	010-709-16	43	011-112-28	49
010-235-12	28	010-542-45	36	010-800-12	44	011-112-30	49
010-240-11	28	010-542-60	36	010-900-09	44	011-113-14	48
010-241-11	28	010-543-25	36	010-900-11	44	011-113-18	49
010-244-09	28	010-543-45	36	010-900-14	44	011-113-20	49
010-244-10	28	010-543-60	36	010-900-18	44	011-113-23	49
010-244-11	28	010-544-25	36	010-900-20	44	011-113-25	49
010-245-09	28	010-544-45	36	010-901-18	44	011-113-28	49
010-245-10	28	010-544-60	36	010-901-21	44	011-113-30	49
010-245-11	28	010-547-18	37	010-903-16	44	011-114-14	48
010-250-10	29	010-548-21	37	010-903-19	44	011-114-18	49
010-250-11	29	010-548-24	37	010-905-23	44	011-114-20	49
010-251-10	29	010-550-12	37	010-907-20	45	011-114-23	49
010-251-11	29	010-550-25	37	010-907-22	45	011-114-25	49
010-261-11	29	010-550-45	37	010-909-24	45	011-114-28	49
010-263-11	29	010-550-60	37	010-910-24	45	011-114-30	49
010-264-12	30	010-550-90	37	010-920-14	45	011-115-14	48
010-265-12	30	010-552-12	38	010-930-23	45	011-115-18	49
010-270-08	30	010-560-15	38	010-940-16	45	011-115-20	49
010-271-08	30	010-561-15	38	010-940-18	45	011-115-23	49
010-276-14	31	010-562-15	38	010-940-20	45	011-115-25	49
010-277-14	31	010-570-19	39	010-940-23	45	011-115-28	49
010-280-12	31	010-572-11	39	010-941-20	45	011-115-30	49
010-283-12	31	010-575-30	39	010-950-14	45	011-120-14	49
010-285-12	31	010-577-24	39	010-950-16	45	011-120-18	50
010-290-10	31	010-579-23	39	010-950-18	45	011-120-20	50
010-290-11	31	010-600-20	39	011-000-14	46	011-120-23	50
010-291-10	31	010-600-23	39	011-000-16	46	011-120-25	50
010-291-11	31	010-601-20	40	011-000-18	46	011-120-28	50
010-294-10	31	010-601-23	40	011-001-14	46	011-120-30	50
010-294-11	31	010-602-20	39	011-001-16	46	011-121-14	49
010-295-10	31	010-602-23	39	011-001-18	46	011-121-18	50
010-295-11	31	010-603-20	40	011-002-14	46	011-121-20	50
010-300-13	32	010-603-23	40	011-002-16	46	011-121-23	50
010-300-14	32	010-604-20	39	011-002-18	46	011-121-25	50
010-302-16	32	010-604-23	39	011-003-14	46	011-121-28	50
010-310-14	32	010-605-20	40	011-003-16	46	011-121-30	50
010-312-12	32	010-605-23	40	011-003-18	46	011-124-14	49
010-315-16	32	010-610-16	40	011-004-14	46	011-124-18	50
010-315-18	32	010-610-17	40	011-004-16	46	011-124-20	50
010-324-18	32	010-611-16	40	011-004-18	46	011-124-23	50
010-325-18	33	010-611-17	40	011-005-14	46	011-124-25	50
010-341-19	33	010-612-16	40	011-005-16	46	011-124-28	50
010-343-15	33	010-620-24	40	011-005-18	46	011-124-30	50
010-400-09	33	010-622-22	40	011-100-14	47	011-125-14	49
010-400-10	33	010-634-16	40	011-100-17	47	011-125-18	50
010-400-13	33	010-634-18	40	011-100-23	47	011-125-20	50
010-402-11	33	010-635-16	41	011-101-14	47	011-125-23	50
010-402-14	33	010-635-18	41	011-101-17	47	011-125-25	50
010-404-14	33	010-640-19	41	011-101-23	47	011-125-28	50
010-404-18	33	010-640-23	41	011-102-15	47	011-125-30	50
010-408-16	34	010-650-18	41	011-102-17	47	011-127-18	51
010-413-13	34	010-651-18	41	011-110-11	48	011-127-20	51
010-415-12	34	010-670-21	41	011-110-14	48	011-127-23	51
010-450-22	34	010-672-21	41	011-110-18	48	011-129-18	51
010-453-17	34	010-674-21	41	011-110-20	48	011-129-20	51
010-457-17	35	010-677-27	41	011-110-23	48	011-129-23	51
010-458-17	35	010-680-31	42	011-110-25	48	011-137-14	50
010-459-17	35	010-681-31	42	011-110-28	48	011-139-17	50
010-501-18	35	010-685-32	42	011-110-30	48	011-140-16	47
010-511-16	35	010-688-25	42	011-111-11	48	011-140-21	47
010-517-18	35	010-688-28	42	011-111-14	48	011-141-16	47
010-519-22	35	010-689-25	42	011-111-18	48	011-141-21	47
010-521-18	36	010-689-28	42	011-111-20	48	011-210-15	51
010-523-17	36	010-691-19	42	011-111-23	48	011-211-15	51
010-525-19	36	010-693-27	42	011-111-25	48	011-244-11	55
010-528-20	36	010-695-18	43	011-111-28	48	011-245-11	55
010-540-25	36	010-701-14	43	011-111-30	48	011-543-25	53

Index numerisch  
Index numerical

011-543-45	53	018-232-15Z	61	020-010-25	64	020-206-30	71
011-543-60	53	018-241-14Z	59	020-010-30	64	020-208-15	72
011-545-25	53	018-241-16Z	59	020-011-10	65	020-209-15	72
011-545-45	53	018-243-14	59	020-011-11	65	020-210-13	70
011-545-60	53	018-243-16	59	020-011-13	65	020-210-14	70
011-548-24	53	018-246-01	59	020-011-14	65	020-210-15	70
011-550-25	54	018-246-02	59	020-011-16	65	020-210-16	70
011-550-45	54	018-246-03	59	020-011-18	65	020-210-18	70
011-550-60	54	018-270-12	60	020-011-20	65	020-210-20	70
011-550-90	54	018-270-25	60	020-011-25	65	020-210-25	70
011-551-25	54	018-270-45	60	020-011-30	65	020-210-30	70
011-551-40	54	018-270-60	60	020-012-13	65	020-212-12	71
011-551-60	54	018-270-90	60	020-012-14	65	020-212-13	71
011-552-17	53	018-271-12	60	020-012-15	65	020-212-14	71
011-600-20	52	018-271-25	60	020-012-18	65	020-212-15	71
011-600-23	52	018-271-45	60	020-012-20	65	020-212-18	71
011-601-20	52	018-271-60	60	020-012-25	65	020-212-20	71
011-601-23	52	018-271-90	60	020-018-10	65	020-212-25	71
011-602-20	52	018-290-01	59	020-018-11	65	020-212-30	71
011-602-23	52	018-290-02	59	020-018-13	65	020-218-13	70
011-603-20	52	018-290-03	59	020-018-14	65	020-218-14	70
011-603-23	52	018-290-04	59	020-018-16	65	020-218-15	70
011-604-20	52	018-291-01	59	020-018-18	65	020-218-16	70
011-604-23	52	018-291-02	59	020-018-20	65	020-218-18	70
011-605-20	52	018-291-03	59	020-018-25	65	020-218-20	70
011-605-23	52	018-291-04	59	020-018-30	65	020-218-25	70
011-663-25	51	018-292-01	59	020-026-18	67	020-218-30	70
011-665-25	51	018-292-02	59	020-026-21	67	020-219-13	70
011-800-12	55	018-293-01	59	020-026-25	67	020-219-14	70
011-900-18	55	018-293-02	59	020-027-18	67	020-219-16	70
011-909-24	55	020-002-10	64	020-027-21	67	020-219-18	70
012-100-17	56	020-002-11	64	020-027-25	67	020-219-20	70
012-101-17	56	020-002-13	64	020-036-13	67	020-226-18	74
012-110-11	57	020-002-14	64	020-036-14	67	020-226-21	74
012-110-14	57	020-002-15	64	020-036-15	67	020-226-25	74
012-111-14	56	020-002-16	64	020-040-12	67	020-227-18	74
012-111-18	56	020-002-18	64	020-040-15	67	020-227-21	74
012-111-20	56	020-002-20	64	020-070-12	66	020-227-25	74
012-111-23	56	020-002-25	64	020-070-15	66	020-236-13	70
012-121-14	56	020-002-30	64	020-076-12	66	020-236-14	70
012-121-18	56	020-003-10	64	020-076-15	66	020-236-15	70
012-121-20	56	020-003-11	64	020-092-17	67	020-240-12	73
012-121-23	56	020-003-13	64	020-093-17	67	020-240-15	73
012-129-15	56	020-003-14	64	020-094-20	67	020-242-12	73
012-129-19	56	020-003-16	64	020-095-20	68	020-252-11	69
012-130-13	56	020-003-18	64	020-102-18	66	020-252-13	69
012-133-18	56	020-003-20	64	020-103-18	67	020-252-14	69
012-139-17	56	020-003-25	64	020-114-17	66	020-252-16	69
012-200-12	58	020-003-30	64	020-115-17	66	020-252-18	69
012-201-12	58	020-004-10	64	020-117-18	66	020-252-20	69
012-210-12	57	020-004-11	64	020-120-18	68	020-252-25	69
012-218-15	57	020-004-13	64	020-126-20	68	020-252-30	69
012-218-18	57	020-004-14	64	020-130-15	68	020-254-13	69
012-240-11	57	020-004-16	64	020-130-20	68	020-254-14	69
012-241-11	57	020-004-18	64	020-136-18	68	020-254-16	69
012-244-11	57	020-004-20	64	020-158-15	66	020-254-18	69
012-245-11	57	020-004-25	64	020-200-10	69	020-254-20	69
012-290-11	57	020-004-30	64	020-200-11	69	020-256-13	69
012-291-11	57	020-006-13	65	020-200-13	69	020-256-14	69
012-343-15	58	020-006-14	65	020-200-14	69	020-256-16	69
012-511-16	58	020-006-15	65	020-200-15	69	020-256-18	69
012-551-25	58	020-006-18	65	020-200-16	69	020-256-20	69
012-551-45	58	020-006-20	65	020-200-18	69	020-270-12	71
012-551-60	58	020-006-25	65	020-200-20	69	020-270-15	71
018-081-11	59	020-006-30	65	020-200-25	69	020-276-12	71
018-083-11	59	020-008-15	66	020-200-30	69	020-276-15	71
018-201-15	60	020-010-10	64	020-206-12	71	020-282-12	72
018-201-18	60	020-010-11	64	020-206-13	71	020-288-12	72
018-203-15	61	020-010-13	64	020-206-14	71	020-288-15	72
018-203-18	61	020-010-14	64	020-206-15	71	020-292-17	74
018-223-15	60	020-010-16	64	020-206-18	71	020-293-17	74
018-223-15Z	60	020-010-18	64	020-206-20	71	020-294-20	74
018-232-15	61	020-010-20	64	020-206-25	71	020-295-20	74

020-300-15	72	020-663-11	77	021-140-25	82	030-160-18	90
020-302-18	73	020-663-13	77	021-158-15	83	030-160-20	90
020-303-18	73	020-663-14	77	021-200-14	82	030-160-25	90
020-314-17	73	020-666-08	77	021-200-18	82	030-161-18	90
020-315-17	73	020-666-09	77	021-200-20	82	030-161-20	90
020-317-17	73	020-666-10	77	021-200-25	82	030-161-25	90
020-330-15	74	020-666-11	77	021-270-12	83	030-170-18	90
020-330-20	74	020-666-13	77	021-270-15	83	030-170-20	90
020-358-15	73	020-666-14	77	021-300-15	83	030-170-25	90
020-382-15	72	020-667-08	77	021-302-17	83	030-171-18	90
020-382-20	72	020-667-09	77	021-590-17	83	030-171-20	90
020-384-15	72	020-667-10	77	026-014-03	94	030-171-25	90
020-384-20	72	020-667-11	77	026-014-05	94	030-180-25	90
020-410-15	76	020-667-13	77	026-015-03	94	030-181-25	90
020-410-20	76	020-667-14	77	026-015-05	94	030-190-18	90
020-410-25	76	020-700-16	81	026-018-04	94	030-190-25	90
020-420-14	76	020-700-20	81	026-018-05	94	030-200-22	89
020-420-20	76	020-700-24	81	026-018-06	94	030-200-25	89
020-422-14	76	020-700-30	81	026-018-07	94	030-200-27	89
020-422-20	76	020-701-16	81	026-018-09	94	030-201-22	89
020-456-15	74	020-701-20	81	026-019-04	94	030-201-25	89
020-456-20	74	020-701-24	81	026-019-05	94	030-201-27	89
020-456-25	74	020-701-30	81	026-019-06	94	030-210-20	90
020-460-14	75	020-702-16	81	026-019-07	94	030-210-22	90
020-460-16	75	020-702-20	81	026-019-09	94	030-210-25	90
020-460-20	75	020-702-24	81	026-292-07	95	030-210-27	90
020-470-12	75	020-702-30	81	026-292-08	95	030-211-20	90
020-470-20	68	020-703-16	81	026-292-10	95	030-211-22	90
020-470-23	75	020-703-20	81	026-292-12	95	030-211-25	90
020-470-34	75	020-703-24	81	026-293-07	95	030-211-27	90
020-494-01	75	020-703-30	81	026-293-08	95	030-300-25	89
020-494-02	75	020-704-16	81	026-293-10	95	030-303-25	89
020-494-03	75	020-704-20	81	026-293-12	95	030-310-25	89
020-510-13	76	020-704-24	81	026-295-23	94	030-311-25	89
020-510-15	76	020-704-30	81	026-298-07	96	030-320-26	88
020-516-23	68	020-706-16	81	026-298-09	96	030-321-26	89
020-518-15	75	020-706-20	81	026-298-11	96	030-351-13	88
020-518-20	75	020-706-24	81	026-299-06	96	030-360-13	88
020-518-23	75	020-706-30	81	026-299-09	96	030-360-16	88
020-520-18	76	020-708-16	81	026-299-11	96	030-360-18	88
020-522-18	76	020-708-20	81	026-520-01	94	032-002-15	91
020-586-14	75	020-708-24	81	026-520-02	94	032-002-18	91
020-587-14	75	020-708-30	81	027-032-35	95	032-002-20	91
020-590-18	76	020-716-16	81	027-032-40	95	032-004-15	91
020-592-18	76	020-716-20	81	027-033-35	95	032-004-18	91
020-601-03	80	020-716-24	81	027-033-40	95	032-004-20	91
020-601-04	80	020-716-30	81	027-042-35	95	032-006-14	91
020-601-05	80	020-718-16	81	027-042-40	95	032-012-16	91
020-601-07	80	020-718-20	81	027-043-35	95	032-012-18	91
020-620-01	80	020-718-24	81	027-043-40	95	032-012-20	91
020-620-02	80	020-718-30	81	030-000-09	86	040-000-10	99
020-620-03	80	020-806-10	78	030-000-11	86	040-001-10	99
020-620-04	80	020-807-10	78	030-000-13	86	040-010-10	98
020-634-12	81	020-809-10	78	030-000-15	86	040-016-10	98
020-634-13	81	020-810-10	79	030-005-11	86	040-020-10	101
020-635-13	81	020-811-10	79	030-010-13	86	040-020-12	101
020-637-13	81	020-813-10	79	030-010-15	87	040-021-10	101
020-650-07	78	020-814-10	79	030-014-10	87	040-021-12	101
020-650-09	78	020-815-10	79	030-014-13	87	040-030-10	101
020-650-11	78	020-817-10	79	030-020-10	88	040-030-12	101
020-652-10	78	021-026-15	83	030-020-13	88	040-031-10	101
020-653-10	78	021-026-18	83	030-024-13	87	040-031-12	101
020-656-10	78	021-026-20	83	030-030-14	88	040-050-12	100
020-657-10	78	021-040-12	82	030-040-15	87	040-050-14	100
020-662-08	77	021-040-15	82	030-040-18	87	040-050-18	100
020-662-09	77	021-070-12	83	030-040-20	87	040-050-21	100
020-662-10	77	021-070-15	83	030-044-16	87	040-051-12	100
020-662-11	77	021-092-17	83	030-101-09	86	040-051-14	100
020-662-13	77	021-093-17	83	030-105-05	86	040-051-18	100
020-662-14	77	021-102-17	83	030-105-07	86	040-051-21	100
020-663-08	77	021-117-18	83	030-105-09	86	040-070-12	100
020-663-09	77	021-140-15	82	030-107-09	86	040-070-14	100
020-663-10	77	021-140-23	82	030-109-09	86	040-070-18	100

Index numerisch  
Index numerical

040-070-21	100	040-353-16	105	040-443-26	111	040-611-21	122
040-071-12	100	040-354-15	103	040-444-21	111	040-611-23	122
040-071-14	100	040-356-15	103	040-444-26	111	040-613-21	122
040-071-18	100	040-358-15	97	040-445-21	111	040-613-23	122
040-071-21	100	040-358-20	97	040-445-26	111	040-614-21	121
040-150-14	101	040-364-14	97	040-448-22	107	040-615-21	121
040-151-14	101	040-366-19	97	040-449-22	107	040-617-21	121
040-152-16	101	040-368-14	99	040-450-24	107	040-621-19	121
040-153-16	101	040-368-16	99	040-451-24	107	040-623-21	121
040-160-14	102	040-369-13	98	040-453-24	104	040-625-23	120
040-161-14	102	040-370-13	96	040-455-01	113	040-629-21	120
040-170-14	102	040-372-13	96	040-455-02	113	040-630-21	119
040-171-14	102	040-376-16	96	040-456-22	115	040-631-21	119
040-180-16	103	040-380-15	102	040-456-23	115	040-650-16	98
040-181-16	103	040-381-15	102	040-456-24	115	040-650-20	98
040-182-16	103	040-382-15	102	040-457-28	114	040-651-16	98
040-183-16	103	040-383-15	102	040-459-18	113	040-651-20	98
040-260-14	106	040-384-20	106	040-459-28	113	040-656-15	98
040-260-16	106	040-384-26	106	040-461-15	113	040-658-25	97
040-260-18	106	040-385-20	106	040-461-19	113	040-658-27	97
040-260-20	106	040-385-26	106	040-463-19	111	040-701-14	118
040-260-22	106	040-386-20	106	040-463-22	111	040-703-18	118
040-260-24	106	040-386-26	106	040-463-24	111	040-709-20	118
040-260-26	106	040-387-20	106	040-465-19	111	040-721-20	119
040-260-30	106	040-387-26	106	040-465-22	111	040-723-20	119
040-261-14	106	040-390-20	107	040-465-24	111	050-010-12	124
040-261-16	106	040-391-20	107	040-467-19	111	050-020-12	124
040-261-18	106	040-393-20	107	040-467-22	111	050-022-12	124
040-261-20	106	040-409-14	108	040-467-24	111	050-028-13	124
040-261-22	106	040-411-14	108	040-471-21	108	050-030-13	124
040-261-24	106	040-411-18	108	040-473-22	113	050-040-13	124
040-261-26	106	040-421-01	110	040-473-23	113	050-046-13	124
040-261-30	106	040-421-02	110	040-475-01	99	050-048-14	124
040-262-13	105	040-421-03	110	040-475-02	99	050-060-15	125
040-262-14	105	040-421-04	110	040-475-18	108	050-070-15	125
040-262-16	105	040-421-05	110	040-477-15	113	050-072-17	125
040-263-13	105	040-421-06	110	040-477-19	113	050-080-14	126
040-263-14	105	040-421-07	110	040-479-22	114	050-080-16	126
040-263-16	105	040-422-01	110	040-479-25	114	050-080-18	126
040-290-13	99	040-422-02	110	040-479-28	114	050-080-20	126
040-290-15	99	040-422-03	110	040-480-15	105	050-080-24	126
040-290-18	99	040-422-04	110	040-480-18	105	050-080-26	126
040-290-20	99	040-422-05	110	040-481-15	105	050-080-30	126
040-291-13	99	040-422-06	110	040-481-18	105	050-090-16	126
040-291-15	99	040-422-07	110	040-497-20	108	050-090-18	126
040-291-18	99	040-423-01	109	040-501-19	114	050-090-20	126
040-291-20	99	040-423-02	109	040-501-23	114	050-096-13	125
040-340-16	105	040-423-03	109	040-503-18	114	050-110-15	126
040-340-20	105	040-423-04	109	040-505-24	115	050-141-21	127
040-341-16	105	040-424-14	102	040-507-22	115	050-148-23	127
040-341-20	105	040-429-18	112	040-509-20	116	050-150-27	127
040-347-14	102	040-429-22	112	040-509-22	116	050-160-27	127
040-350-14	106	040-429-25	112	040-509-24	116	050-190-18	125
040-350-16	106	040-429-28	112	040-511-23	116	050-192-18	125
040-350-18	106	040-431-14	112	040-513-23	116	050-193-27	127
040-350-20	106	040-431-16	112	040-517-23	117	050-211-27	127
040-350-22	106	040-431-18	112	040-523-22	115	050-230-23	128
040-350-24	106	040-431-20	112	040-523-23	115	050-306-14	128
040-350-26	106	040-431-23	112	040-525-22	115	050-310-14	128
040-350-30	106	040-431-25	112	040-525-23	115	050-310-17	128
040-351-14	106	040-431-28	112	040-529-21	114	050-310-18	128
040-351-16	106	040-433-20	112	040-533-01	107	050-350-14	129
040-351-18	106	040-433-24	112	040-533-02	107	050-350-17	129
040-351-20	106	040-433-28	112	040-540-19	103	050-350-20	129
040-351-22	106	040-436-21	114	040-541-19	103	050-354-14	129
040-351-24	106	040-438-21	114	040-543-19	112	050-354-17	129
040-351-26	106	040-441-01	109	040-543-21	112	050-356-17	129
040-351-30	106	040-441-02	109	040-543-24	112	050-356-20	129
040-352-13	105	040-441-03	109	040-601-24	119	050-358-14	130
040-352-14	105	040-441-04	109	040-602-25	119	050-358-17	130
040-352-16	105	040-442-21	111	040-606-20	120	050-358-20	130
040-353-13	105	040-442-26	111	040-606-25	120	050-362-18	128
040-353-14	105	040-443-21	111	040-607-21	121	050-550-10	130



050-551-10	130	051-224-18	134	056-333-21	147	062-058-01	158
050-570-14	131	051-224-20	134	056-333-27	147	062-058-02	158
050-570-18	131	051-224-26	134	056-450-20	147	062-058-03	158
050-571-14	131	051-230-22	140	056-451-19	147	062-060-13	158
050-571-18	131	051-230-23	140	056-451-20	147	062-070-01	159
050-576-14	131	051-240-15	139	056-452-01	148	062-070-02	159
050-576-18	131	051-242-20	139	056-452-02	148	062-070-03	159
050-577-14	131	051-250-16	133	056-452-03	148	062-070-04	159
050-577-18	131	051-250-18	133	056-454-01	148	062-074-16	158
050-600-18	131	051-250-20	133	056-454-02	148	062-078-01	158
050-601-14	130	051-250-23	133	056-455-25	148	062-078-02	158
050-601-18	131	051-250-26	133	056-458-21	148	062-080-01	159
050-621-13	130	051-310-14	140	056-460-01	149	062-080-02	159
050-630-18	131	051-310-17	140	056-460-02	149	062-082-01	160
050-631-18	131	051-310-18	140	056-460-03	149	062-082-02	160
050-650-14	132	051-330-16	140	056-467-01	149	062-088-02	160
050-651-14	132	051-350-14	141	056-467-02	149	062-088-03	160
050-653-14	132	051-350-17	141	056-468-15	149	062-088-04	160
050-661-14	132	051-350-20	141	056-469-14	149	062-089-02	160
050-663-14	132	051-356-17	142	056-470-01	149	062-089-03	160
050-671-13	132	051-356-20	142	056-470-02	150	062-089-04	160
050-673-13	132	051-356-23	142	056-472-23	150	062-101-01	160
051-010-12	133	051-358-14	141	056-473-23	150	062-101-02	160
051-028-13	133	051-358-17	141	056-474-01	150	062-101-03	160
051-029-13	133	051-358-20	141	056-474-02	150	062-101-04	160
051-030-13	134	051-360-18	143	056-477-24	150	062-102-01	160
051-040-13	134	051-360-20	143	056-480-01	150	062-102-02	160
051-048-12	133	051-360-23	143	056-480-02	150	062-102-03	160
051-048-14	133	051-362-18	140	056-481-23	150	062-102-04	160
051-060-15	134	051-364-20	143	056-500-01	151	062-103-01	160
051-060-18	134	051-364-23	143	056-500-02	151	062-103-02	160
051-080-16	135	051-366-17	142	056-500-03	151	062-103-03	160
051-080-18	135	051-366-20	142	056-500-04	151	062-103-04	160
051-080-20	135	051-390-18	144	056-502-22	152	062-111-01	161
051-080-24	135	051-428-14	133	056-503-22	152	062-111-02	161
051-080-26	135	051-560-14	144	056-506-19	152	062-111-03	161
051-080-30	135	051-561-14	144	056-507-19	152	062-111-04	161
051-084-20	139	051-562-14	144	056-508-03	152	062-112-01	161
051-084-24	139	051-563-14	144	056-508-05	152	062-112-02	161
051-090-14	138	051-570-14	144	056-508-07	152	062-112-03	161
051-090-18	138	051-570-18	144	056-510-25	153	062-112-04	161
051-090-20	138	051-571-14	144	056-510-28	153	062-140-01	161
051-090-23	138	051-571-18	144	056-513-15	153	062-140-02	161
051-114-18	136	051-576-14	144	056-513-16	153	062-150-01	162
051-114-20	136	051-576-18	144	056-514-15	153	062-150-02	162
051-114-23	136	051-577-14	144	056-514-16	153	062-150-03	162
051-114-26	136	051-577-18	144	056-516-18	153	062-150-04	162
051-114-31	136	056-211-01	145	056-521-18	153	062-150-05	162
051-114-37	136	056-211-02	145	056-521-27	153	062-150-06	162
051-132-13	136	056-211-03	145	056-530-23	154	062-160-10	162
051-132-15	136	056-211-04	145	056-531-21	154	062-160-20	162
051-132-18	136	056-221-01	145	056-532-23	154	062-162-01	161
051-132-20	136	056-221-02	145	056-550-12	154	062-162-02	161
051-132-23	136	056-221-03	145	056-552-13	154	062-164-01	162
051-132-26	136	056-221-04	145	056-553-14	154	062-164-02	162
051-134-13	137	056-223-01	145	056-555-01	154	062-164-03	162
051-134-15	137	056-223-02	145	056-556-12	154	062-164-04	162
051-134-18	137	056-223-03	145	056-558-00	155	062-166-16	162
051-134-20	137	056-223-04	145	056-558-12	155	062-170-14	163
051-134-23	137	056-320-20	146	056-559-10	155	062-174-15	163
051-134-26	137	056-321-20	146	056-560-01	155	062-178-15	163
051-136-15	137	056-322-20	146	056-560-02	155	062-179-15	163
051-136-17	137	056-323-20	146	056-570-08	155	062-180-16	163
051-136-20	137	056-324-21	147	056-570-11	155	062-181-16	163
051-141-20	135	056-324-27	147	056-570-12	155	062-200-08	164
051-141-24	135	056-325-21	147	056-570-14	155	062-200-10	164
051-141-26	135	056-325-27	147	056-570-16	155	062-200-12	164
051-150-27	138	056-328-20	146	056-570-18	155	062-200-14	164
051-160-27	138	056-329-20	146	056-570-20	155	062-200-16	164
051-185-20	139	056-330-20	146	056-570-22	155	062-200-18	164
051-185-24	139	056-331-20	146	062-050-01	158	062-204-08	164
051-185-26	139	056-332-21	147	062-050-02	158	062-204-10	164
051-211-27	138	056-332-27	147	062-054-15	158	062-204-12	164

Index numerisch  
Index numerical

062-204-14	164	064-012-06	172	064-272-90	181	070-611-05	188
062-204-16	164	064-012-08	172	064-274-01	181	070-611-07	188
062-204-18	164	064-013-01	172	064-274-02	181	070-620-07	188
062-210-08	165	064-013-02	172	064-274-03	181	070-620-10	188
062-210-10	165	064-013-03	172	064-280-61	180	070-621-07	188
062-210-12	165	064-013-04	172	064-280-62	180	070-621-10	188
062-210-14	165	064-013-06	172	064-280-91	180	070-622-07	188
062-210-16	165	064-013-08	172	064-280-92	180	070-622-10	188
062-210-18	165	064-021-24	173	064-290-38	181	070-630-10	188
062-212-08	165	064-022-24	173	064-290-51	181	070-631-10	188
062-212-10	165	064-032-04	173	064-320-25	182	070-650-10	191
062-212-12	165	064-032-05	173	064-320-26	182	070-651-10	191
062-212-14	165	064-032-06	173	064-320-27	182	070-660-14	189
062-212-16	165	064-032-07	173	064-350-16	183	070-661-14	189
062-212-18	165	064-100-55	173	064-350-25	183	070-670-13	191
062-220-08	166	064-100-60	173	064-350-50	183	070-670-16	191
062-220-11	166	064-100-63	173	064-360-08	183	070-670-20	191
062-220-13	166	064-110-30	174	064-360-10	183	070-671-13	191
062-220-17	166	064-110-31	174	064-360-12	183	070-671-16	191
062-220-20	166	064-110-32	174	064-360-14	183	070-671-20	191
062-220-23	166	064-110-40	174	064-360-16	183	070-672-11	192
062-230-08	166	064-110-50	174	064-360-18	183	070-673-11	192
062-230-11	166	064-120-30	174	064-370-08	184	070-674-15	190
062-230-13	166	064-120-31	174	064-370-10	184	070-684-16	189
062-230-17	166	064-120-32	174	064-370-12	184	070-685-16	189
062-230-20	166	064-120-40	174	064-370-14	184	070-690-31	194
062-230-23	166	064-120-50	174	064-370-16	184	070-691-32	195
062-250-20	166	064-130-22	175	064-370-18	184	070-810-10	190
062-300-12	167	064-130-25	175	064-390-01	182	070-810-13	190
062-302-15	167	064-130-26	175	064-390-02	182	070-810-15	190
062-310-00	167	064-130-35	175	064-390-03	182	070-810-18	190
062-310-01	167	064-130-36	175	064-500-40	182	070-811-10	190
062-310-02	167	064-130-37	175	064-500-62	182	070-811-13	190
062-310-03	167	064-130-40	175	064-600-25	186	070-811-15	190
062-310-04	167	064-130-70	175	064-600-38	186	070-811-18	190
062-340-06	168	064-130-80	175	064-600-50	186	070-822-17	190
062-342-13	168	064-130-85	175	064-600-75	186	070-830-13	192
062-350-00	168	064-140-18	176	064-602-18	184	070-831-13	192
062-360-00	168	064-140-20	176	064-602-22	184	070-840-13	192
062-370-16	169	064-140-25	176	064-602-23	184	070-850-13	193
062-370-20	169	064-140-30	176	064-604-30	185	070-860-20	193
062-370-25	169	064-140-40	176	064-604-33	185	070-860-26	193
062-380-00	168	064-150-44	176	064-604-36	185	070-861-20	193
062-390-00	169	064-150-55	176	064-610-38	185	070-861-26	193
062-396-19	169	064-150-72	176	064-610-50	185	070-870-01	194
064-001-01	170	064-164-20	180	064-610-75	185	070-870-02	194
064-001-02	170	064-180-01	177	064-700-30	186	070-870-03	194
064-001-03	170	064-180-02	177	064-700-32	186	070-870-04	194
064-001-04	170	064-180-03	177	064-710-50	186	070-871-01	194
064-001-06	170	064-182-01	177	064-710-90	186	070-871-02	194
064-001-08	170	064-182-02	177	064-720-01	186	070-871-03	194
064-002-01	171	064-182-03	177	064-720-02	186	070-871-04	194
064-002-02	171	064-192-01	178	064-721-01	186	074-310-01	200
064-002-03	171	064-192-02	178	064-721-02	186	074-310-02	200
064-002-04	171	064-192-03	178	070-202-14	193	074-310-03	200
064-002-06	171	064-200-00	178	070-202-19	193	074-310-28	198
064-002-08	171	064-200-01	178	070-240-10	195	074-312-30	198
064-003-01	170	064-200-02	178	070-240-14	195	074-330-24	199
064-003-02	170	064-220-01	179	070-250-19	193	074-331-01	200
064-003-03	170	064-220-02	179	070-300-16	197	074-331-02	200
064-003-04	170	064-220-03	179	070-300-19	197	074-331-03	200
064-003-06	170	064-230-50	178	070-300-25	197	074-332-24	199
064-003-08	170	064-240-40	178	070-300-32	197	074-334-24	199
064-011-01	171	064-240-50	178	070-301-16	197	074-360-01	200
064-011-02	171	064-240-60	178	070-320-17	198	074-360-02	200
064-011-03	171	064-240-75	178	070-330-18	198	074-360-03	200
064-011-04	171	064-240-85	178	070-330-23	198	074-360-27	199
064-011-06	171	064-250-70	179	070-401-22	196	074-398-01	200
064-011-08	171	064-250-81	179	070-411-17	196	074-398-02	200
064-012-01	172	064-250-82	179	070-420-17	196	074-398-03	200
064-012-02	172	064-250-83	179	070-430-15	196	074-398-10	200
064-012-03	172	064-260-01	180	070-610-05	188	074-398-11	200
064-012-04	172	064-260-02	180	070-610-07	188	074-398-12	200

074-398-13	200	074-910-12	209	080-150-00	217	084-184-55	221
074-399-01	200	074-910-13	209	080-150-01	217	084-190-14	220
074-399-02	200	074-910-14	209	080-150-03	217	085-000-27	222
074-399-03	200	074-915-30	209	080-150-06	217	085-006-24	222
074-399-10	200	074-920-01	209	080-150-09	217	085-007-26	222
074-399-13	200	074-920-02	209	080-150-12	217	085-008-27	222
074-399-14	200	074-920-10	209	080-150-20	217	085-010-17	222
074-399-23	200	074-920-11	209	080-150-21	217	085-010-35	222
074-399-33	200	074-920-12	209	080-150-22	217	085-012-15	223
074-400-10	201	074-920-13	209	080-260-16	216	085-012-25	223
074-412-14	201	074-920-16	209	080-262-18	216	085-012-35	223
074-414-16	201	074-920-20	209	080-264-28	216	085-014-23	222
074-610-00	203	078-170-13	210	080-270-12	216	085-016-22	223
074-760-09	203	078-170-25	210	080-270-14	216	085-020-06	221
074-764-18	202	078-170-32	210	080-270-16	216	085-020-10	221
074-768-20	202	078-170-40	210	080-270-18	216	085-021-06	221
074-768-25	202	078-170-50	210	080-271-12	216	085-021-08	221
074-772-01	202	078-200-01	210	080-271-14	216	085-024-00	222
074-772-02	202	078-200-02	210	080-271-16	216	085-024-01	222
074-772-25	202	078-200-03	210	080-271-18	216	085-024-02	222
074-798-01	203	078-210-06	210	084-100-03	218	085-024-03	222
074-798-02	203	078-210-12	210	084-100-04	218	085-024-04	222
074-798-03	203	078-210-17	210	084-102-03	219	085-030-06	223
074-799-70	203	078-210-20	210	084-102-04	219	085-030-08	223
074-850-18	203	078-210-25	210	084-110-30	218	085-030-10	223
074-850-23	203	078-220-20	210	084-110-35	218	085-030-12	223
074-850-30	203	078-230-28	210	084-110-40	218	085-033-06	223
074-850-45	203	080-000-11	214	084-110-45	218	085-033-08	223
074-859-01	204	080-000-13	214	084-110-50	218	085-033-10	223
074-859-02	204	080-000-14	214	084-110-55	218	085-033-12	223
074-859-03	204	080-000-16	214	084-110-60	218	085-034-06	223
074-859-04	204	080-000-18	214	084-112-30	218	085-034-08	223
074-859-05	204	080-000-20	214	084-112-35	218	085-034-10	223
074-859-06	204	080-004-11	214	084-112-40	218	085-034-12	223
074-859-07	204	080-004-13	214	084-112-45	218	085-050-21	223
074-859-08	204	080-004-14	214	084-112-50	218	085-060-01	223
074-859-09	204	080-004-16	214	084-112-55	218	085-060-02	223
074-860-00	205	080-004-18	214	084-112-60	218	085-060-03	223
074-860-01	205	080-004-20	214	084-114-30	218	085-060-04	223
074-860-11	205	080-013-11	214	084-114-35	218	086-000-01	224
074-860-22	205	080-013-13	214	084-114-40	218	086-000-02	224
074-870-00	205	080-013-14	214	084-114-45	218	086-000-03	224
074-870-01	205	080-013-16	214	084-114-50	218	086-000-04	224
074-870-11	205	080-013-18	214	084-114-55	218	086-000-05	224
074-880-00	206	080-013-20	214	084-114-60	218	086-000-06	224
074-880-01	206	080-027-11	214	084-118-07	218	086-000-07	224
074-880-02	206	080-027-13	214	084-118-09	218	086-060-16	225
074-880-03	206	080-027-14	214	084-118-12	218	086-090-12	226
074-880-11	207	080-027-16	214	084-120-01	220	086-090-14	226
074-880-12	207	080-027-18	214	084-120-02	220	086-090-16	226
074-880-13	206	080-027-20	214	084-120-03	220	086-115-01	226
074-880-14	206	080-033-10	214	084-120-04	220	086-115-02	226
074-880-15	206	080-110-11	215	084-124-24	219	086-115-03	226
074-880-16	206	080-110-13	215	084-128-06	220	086-115-04	226
074-880-17	206	080-110-14	215	084-128-08	220	086-115-05	226
074-880-20	207	080-110-16	215	084-130-20	220	086-115-06	226
074-880-21	207	080-110-18	215	084-130-25	220	086-115-07	226
074-882-00	206	080-110-20	215	084-130-30	220	086-115-08	226
074-882-01	206	080-117-14	214	084-140-01	220	086-117-14	226
074-884-00	207	080-120-16	214	084-140-02	220	086-117-18	226
074-890-01	207	080-122-11	215	084-140-03	220	086-120-01	226
074-890-11	208	080-122-13	215	084-140-04	220	086-120-02	226
074-890-12	208	080-122-14	215	084-160-16	219	086-120-03	226
074-890-13	208	080-122-16	215	084-161-16	219	086-120-04	226
074-890-14	208	080-122-18	215	084-170-00	221	086-120-05	226
074-890-15	208	080-126-20	214	084-172-00	221	086-120-06	226
074-900-00	208	080-130-01	215	084-175-00	221	086-120-07	226
074-900-01	208	080-130-02	215	084-180-30	220	086-130-01	225
074-900-11	208	080-130-03	215	084-180-40	220	086-130-02	225
074-900-12	208	080-130-04	215	084-180-50	220	086-130-03	225
074-900-13	208	080-135-01	256	084-184-30	221	086-130-04	225
074-900-14	208	080-135-02	256	084-184-40	221	086-130-05	225
074-910-11	209	080-135-03	256	084-184-50	221	086-130-06	225

Index numerisch  
Index numerical

086-140-03	224	140-100-01	211	160-006-24	244	164-231-23	248
086-140-04	224	140-100-02	211	160-010-15	243	164-231-25	248
086-140-05	224	140-100-03	211	160-012-15	243	164-234-22	247
086-140-06	224	140-100-04	211	160-014-20	243	164-234-25	247
086-150-01	224	140-150-01	211	160-020-15	242	164-234-28	247
086-150-14	224	141-001-22	117	160-020-20	242	164-235-22	247
086-180-10	225	141-002-01	118	160-020-23	242	164-235-25	247
086-180-12	225	141-002-02	118	160-030-12	242	164-235-28	247
086-180-15	225	141-003-01	118	160-030-15	242	164-240-24	248
086-200-06	224	141-003-02	118	160-030-19	242	168-010-19	251
086-210-12	225	141-004-20	117	160-040-15	243	168-020-26	251
086-210-15	225	141-005-20	117	160-040-19	243	168-020-28	251
086-650-16	225	154-001-01	232	160-050-20	243	168-108-15	252
086-650-20	225	154-001-02	232	160-070-16	244	168-110-15	252
087-000-01	227	154-005-20	233	160-124-16	242	168-124-25	254
087-000-02	227	154-006-20	233	160-124-20	242	168-124-29	254
087-000-05	227	154-008-20	232	160-124-25	242	168-124-38	254
087-000-10	227	154-009-20	232	160-124-30	242	168-147-00	253
087-000-20	227	154-021-22	232	160-170-18	245	168-147-03	253
087-000-50	227	154-031-01	233	160-170-20	245	168-147-75	253
087-001-01	227	154-031-03	233	160-172-20	245	168-147-95	253
087-001-02	227	154-039-24	233	160-172-23	245	168-150-21	252
087-001-05	227	154-050-01	236	160-178-16	242	168-160-15	252
087-001-10	227	154-050-02	236	160-178-20	242	168-200-00	253
087-001-20	227	154-050-03	236	160-200-18	245	168-212-01	253
087-001-50	227	154-050-04	236	160-201-18	245	168-212-02	253
087-050-01	227	154-050-05	236	160-210-21	245	168-212-03	253
087-050-02	227	154-050-06	236	160-210-23	245	168-212-04	253
087-050-05	227	154-050-07	236	160-211-21	245	168-220-01	254
087-050-10	227	154-050-08	236	160-211-23	245	168-220-02	254
087-050-20	227	154-050-09	236	160-230-21	247	168-220-03	254
087-050-50	227	154-050-10	236	160-230-23	247	168-220-04	254
087-051-01	227	154-050-11	236	160-230-25	247	168-220-05	254
087-051-02	227	154-050-12	236	160-231-21	247	168-220-06	254
087-051-05	227	154-050-13	236	160-231-23	247	168-250-22	254
087-051-10	227	154-056-13	235	160-231-25	247	168-250-30	254
087-051-20	227	154-056-18	235	160-234-22	246	168-268-01	254
087-051-50	227	154-056-21	235	160-234-25	246	168-268-02	254
087-055-02	227	154-058-18	235	160-234-28	246	168-280-01	253
087-055-05	227	154-058-21	235	160-235-22	246	168-280-02	253
087-055-10	227	154-058-24	235	160-235-25	246	168-280-03	253
087-060-01	227	154-058-27	235	160-235-28	246	168-280-04	253
087-060-02	227	154-070-01	234	160-240-24	248	168-280-05	253
087-061-01	227	154-072-01	234	160-253-23	248	168-300-28	255
087-061-02	227	154-074-01	234	160-259-23	248	168-300-35	255
087-065-01	228	154-074-02	234	160-310-15	249	168-300-42	255
087-066-01	228	154-076-34	234	160-310-21	249	168-301-28	255
087-070-05	228	154-078-32	235	160-310-29	249	168-301-35	255
087-070-10	228	154-080-01	234	160-311-15	249	168-301-42	255
087-070-15	228	154-080-02	234	160-311-21	249	168-311-28	255
087-070-20	228	154-080-03	234	160-311-29	249	168-311-35	255
087-071-05	228	154-080-04	234	160-320-05	249	168-311-42	255
087-071-10	228	154-080-05	234	160-320-07	249	168-312-28	255
087-071-15	228	154-080-06	234	160-320-10	249	168-312-35	255
087-071-20	228	154-080-07	234	160-325-26	249	168-312-42	255
087-080-10	228	154-080-08	234	160-340-08	249	168-400-00	255
087-080-20	228	154-082-35	235	160-360-30	250	168-410-00	255
087-080-30	228	158-001-01	232	160-361-30	250	168-471-19	256
087-080-50	228	158-001-02	232	160-364-33	250	168-473-19	256
087-081-10	228	158-001-03	232	160-365-33	250	170-055-01	117
087-081-20	228	158-001-04	232	161-006-16	244	170-055-02	117
087-081-30	228	158-001-05	232	161-006-20	244	170-071-24	238
087-081-50	228	158-001-06	232	161-170-20	244	170-073-23	238
087-911-00	229	158-519-23	116	164-006-16	244	170-075-23	238
087-912-06	229	158-519-24	116	164-006-20	244	170-077-24	238
087-912-08	229	160-000-12	242	164-210-21	246	170-080-20	238
087-913-00	229	160-000-15	242	164-210-23	246	170-080-28	238
087-920-00	229	160-004-15	242	164-211-21	246	170-150-28	238
087-922-00	229	160-004-19	242	164-211-23	246	170-160-00	237
087-926-00	229	160-004-25	242	164-230-21	248	170-172-00	237
087-930-02	229	160-006-16	244	164-230-23	248	170-176-00	237
087-935-00	229	160-006-18	244	164-230-25	248	170-176-01	237
087-939-00	229	160-006-20	244	164-231-21	248	170-176-02	237

170-176-03	237	180-146-01	259	180-270-01	265	180-350-25	270
170-176-04	237	180-146-02	259	180-270-02	265	180-350-26	270
170-182-00	237	180-146-03	259	180-271-01	265	180-350-98	270
170-230-21	239	180-150-01	260	180-271-02	265	180-350-99	270
170-236-22	239	180-150-02	260	180-272-01	265	180-351-01	270
170-238-21	239	180-150-03	260	180-272-02	265	180-351-02	270
170-240-22	239	180-160-00	260	180-275-17	265	180-351-03	270
170-250-26	239	180-170-00	261	180-290-01	265	180-351-04	270
170-257-23	239	180-172-00	261	180-290-02	265	180-351-05	270
170-345-08	240	180-180-00	261	180-290-03	265	180-351-06	270
170-349-11	240	180-180-03	261	180-290-17	265	180-351-07	270
170-350-08	240	180-180-04	261	180-292-01	266	180-351-08	270
170-350-11	240	180-180-05	261	180-292-02	266	180-351-09	270
170-350-13	240	180-180-06	261	180-292-03	266	180-351-10	270
170-350-16	240	180-180-07	261	180-292-04	266	180-351-11	270
170-350-21	240	180-180-08	261	180-294-01	267	180-351-12	270
170-350-26	240	180-180-40	261	180-294-02	267	180-351-13	270
170-350-32	240	180-180-80	261	180-294-03	267	180-351-14	270
170-360-00	240	180-220-01	262	180-300-01	267	180-351-15	270
170-650-08	240	180-220-02	262	180-300-02	267	180-351-16	270
170-650-10	240	180-220-03	262	180-301-01	267	180-351-17	270
170-650-12	240	180-221-01	262	180-301-02	267	180-354-01	271
170-650-14	240	180-221-02	262	180-305-01	267	180-354-03	271
170-650-16	240	180-221-03	262	180-305-02	267	180-354-05	271
170-650-18	240	180-222-01	262	180-307-20	268	180-354-07	271
170-650-20	240	180-222-02	262	180-307-25	268	180-354-09	271
170-650-22	240	180-222-03	262	180-307-30	268	180-354-11	271
170-650-24	240	180-230-01	262	180-307-35	268	180-354-13	271
170-660-06	240	180-230-03	262	180-307-40	268	180-354-15	271
170-660-07	240	180-231-01	262	180-308-20	268	180-354-17	271
170-660-08	240	180-231-02	262	180-308-25	268	180-354-19	271
170-660-09	240	180-231-03	262	180-308-30	268	180-354-21	271
170-660-10	240	180-232-01	262	180-308-35	268	180-354-23	271
170-660-11	240	180-232-02	262	180-308-40	268	180-354-25	271
170-660-12	240	180-232-03	262	180-309-40	268	180-354-98	271
170-660-13	240	180-234-00	263	180-310-20	268	180-354-99	271
170-660-14	240	180-234-01	263	180-311-10	268	180-360-05	271
170-660-15	240	180-234-02	263	180-311-20	268	180-360-06	271
170-660-16	240	180-234-03	263	180-311-25	268	180-360-07	271
170-660-18	240	180-235-00	263	180-312-15	268	180-360-08	271
170-660-20	240	180-235-01	263	180-312-20	268	180-360-09	271
170-660-24	240	180-235-02	263	180-312-25	268	180-360-10	271
180-090-03	269	180-235-03	263	180-312-30	268	180-360-98	271
180-090-04	269	180-236-00	263	180-312-35	268	180-370-05	272
180-090-05	269	180-236-01	263	180-312-40	268	180-370-06	272
180-092-03	269	180-236-02	263	180-313-19	268	180-370-08	272
180-092-04	269	180-236-03	263	180-315-23	268	180-370-09	272
180-092-05	269	180-237-01	263	180-315-25	268	180-370-10	272
180-096-25	269	180-237-02	263	180-317-30	268	180-370-12	272
180-100-01	260	180-238-01	263	180-350-01	270	180-370-13	272
180-100-02	260	180-238-02	263	180-350-02	270	180-370-14	272
180-100-03	260	180-239-01	263	180-350-03	270	180-370-98	272
180-120-01	260	180-239-02	263	180-350-04	270	180-400-25	273
180-120-02	260	180-260-01	264	180-350-05	270	180-402-26	273
180-120-03	260	180-260-02	264	180-350-06	270	180-404-25	273
180-130-01	258	180-260-03	264	180-350-07	270	180-410-18	272
180-130-02	258	180-261-01	264	180-350-08	270	180-412-19	272
180-130-03	258	180-261-02	264	180-350-09	270	180-414-17	272
180-132-00	258	180-261-03	264	180-350-10	270	180-417-20	273
180-134-00	258	180-261-04	264	180-350-11	270	180-419-28	273
180-140-00	259	180-262-01	264	180-350-12	270	180-421-24	273
180-140-01	259	180-262-02	264	180-350-13	270	180-423-24	274
180-140-02	259	180-262-03	264	180-350-14	270	180-426-24	274
180-140-03	259	180-262-04	264	180-350-15	270	180-429-24	274
180-142-01	258	180-264-01	264	180-350-16	270	180-431-23	274
180-142-02	258	180-264-02	264	180-350-17	270	180-434-21	274
180-142-03	258	180-264-03	264	180-350-18	270	180-435-21	274
180-142-04	258	180-265-01	264	180-350-19	270	180-440-06	275
180-142-05	258	180-265-02	264	180-350-20	270	180-440-08	275
180-142-06	258	180-265-03	264	180-350-21	270	180-440-10	275
180-144-01	259	180-266-01	264	180-350-22	270	180-441-06	275
180-144-02	259	180-266-02	264	180-350-23	270	180-441-08	275
180-144-03	259	180-266-03	264	180-350-24	270	180-441-10	275

Index numerisch  
Index numerical

180-442-15	275	180-700-20	280	180-712-05	283	181-600-34	292
180-444-20	275	180-700-21	280	180-712-06	283	186-000-14	295
180-446-28	275	180-700-23	280	180-712-07	283	186-002-14	295
180-449-26	275	180-701-05	280	180-712-08	283	186-010-10	295
180-470-20	276	180-701-06	280	180-712-09	283	186-012-14	295
180-472-27	276	180-701-07	280	180-712-11	283	186-020-10	295
180-475-32	276	180-701-08	280	180-712-12	283	186-100-03	295
180-480-25	276	180-701-09	280	180-712-14	283	186-100-04	295
180-482-27	276	180-701-11	280	180-712-15	283	186-100-05	295
180-485-23	276	180-701-12	280	180-712-16	283	186-100-06	295
180-488-25	277	180-701-14	280	180-712-19	283	186-110-03	294
180-500-26	277	180-701-15	280	180-712-20	283	186-110-04	294
180-502-28	277	180-701-16	280	180-712-21	283	186-110-05	294
180-510-32	277	180-701-19	280	180-712-23	283	186-200-02	294
180-511-32	277	180-701-20	280	180-713-05	283	186-200-03	294
180-516-32	277	180-701-21	280	180-713-06	283	186-200-04	294
180-518-32	277	180-701-23	280	180-713-07	283	186-200-05	294
180-521-25	277	180-702-05	281	180-713-08	283	186-200-06	294
180-527-29	277	180-702-06	281	180-713-09	283	186-200-07	294
180-529-28	277	180-702-07	281	180-713-11	283	186-200-08	294
180-530-00	269	180-702-08	281	180-713-12	283	186-210-00	294
180-530-01	269	180-702-09	281	180-713-14	283	186-400-00	294
180-530-02	269	180-702-11	281	180-713-15	283	186-400-01	294
180-540-30	278	180-702-12	281	180-713-16	283	186-400-02	294
180-542-30	278	180-702-14	281	180-713-19	283	186-400-03	294
180-543-30	278	180-702-15	281	180-713-20	283	186-420-01	296
180-550-04	278	180-702-16	281	180-713-21	283	186-420-17	296
180-552-04	278	180-702-19	281	180-713-23	283	186-430-01	296
180-560-04	278	180-702-20	281	180-720-30	284	186-430-16	296
180-560-06	278	180-702-21	281	180-720-35	284	186-500-13	296
180-560-09	278	180-702-23	281	180-720-40	284	186-510-13	296
180-570-25	279	180-703-05	281	180-721-30	284	186-600-13	296
180-572-25	279	180-703-06	281	180-721-35	284	186-610-01	296
180-574-22	279	180-703-07	281	180-721-40	284	186-610-02	296
180-576-01	279	180-703-08	281	180-722-30	285	191-132-20	306
180-576-02	279	180-703-09	281	180-722-35	285	191-145-18	306
180-576-03	279	180-703-11	281	180-722-40	285	191-201-24	306
180-576-04	279	180-703-12	281	180-723-30	285	192-406-00	300
180-576-05	279	180-703-14	281	180-723-35	285	192-406-01	300
180-580-27	279	180-703-15	281	180-723-40	285	192-406-02	300
180-588-01	279	180-703-16	281	180-760-01	286	192-408-00	300
180-588-02	279	180-703-19	281	180-760-02	286	192-408-01	300
180-602-25	287	180-703-20	281	180-760-03	286	192-408-12	300
180-604-20	287	180-703-21	281	180-760-04	286	192-410-16	300
180-608-28	287	180-703-23	281	180-760-05	286	192-411-15	300
180-610-04	287	180-710-05	282	180-760-06	286	192-414-13	300
180-610-06	287	180-710-06	282	181-034-30	289	192-414-14	300
180-614-23	287	180-710-07	282	181-036-33	289	192-414-17	300
180-615-23	287	180-710-08	282	181-036-36	289	192-430-11	300
180-630-10	288	180-710-09	282	181-044-36	290	192-430-12	300
180-630-12	288	180-710-11	282	181-046-36	289	192-448-00	299
180-630-14	288	180-710-12	282	181-052-41	290	192-448-01	299
180-630-40	288	180-710-14	282	181-054-40	290	192-448-02	299
180-630-41	288	180-710-15	282	181-056-28	289	192-448-03	299
180-630-50	288	180-710-16	282	181-058-30	289	192-448-04	299
180-680-24	286	180-710-19	282	181-058-36	289	192-452-01	299
180-682-21	286	180-710-20	282	181-058-38	289	192-452-02	299
180-682-29	286	180-710-21	282	181-060-44	290	192-452-11	299
180-684-24	286	180-710-23	282	181-080-32	290	192-467-01	298
180-686-24	287	180-711-05	282	181-080-38	290	192-467-02	298
180-688-21	287	180-711-06	282	181-084-36	290	192-467-03	298
180-690-26	287	180-711-07	282	181-084-40	290	192-467-11	298
180-700-05	280	180-711-08	282	181-200-21	291	192-467-12	298
180-700-06	280	180-711-09	282	181-244-01	291	192-467-13	298
180-700-07	280	180-711-11	282	181-244-02	291	192-467-14	298
180-700-08	280	180-711-12	282	181-244-03	291	192-469-01	298
180-700-09	280	180-711-14	282	181-245-01	291	192-469-02	298
180-700-11	280	180-711-15	282	181-245-02	291	192-469-03	298
180-700-12	280	180-711-16	282	181-245-03	291	192-469-04	298
180-700-14	280	180-711-19	282	181-252-30	291	192-469-11	298
180-700-15	280	180-711-20	282	181-260-27	291	192-469-12	298
180-700-16	280	180-711-21	282	181-261-27	291	192-469-13	298
180-700-19	280	180-711-23	282	181-300-42	292	192-469-14	298

192-469-15	298	194-336-04	304	250-140-27	309
192-469-16	298	194-336-05	304	250-142-06	309
192-472-01	298	194-336-06	304	250-142-07	309
192-472-02	298	194-350-06	305	250-142-08	309
192-472-03	298	194-350-09	305	250-142-09	309
192-472-04	298	194-350-13	305	250-151-14	308
192-472-11	298	194-350-16	305	250-154-12	308
192-472-12	298	194-350-19	305	250-160-20	308
192-472-13	298	194-350-25	305	250-163-27	308
192-472-14	298	194-350-32	305	250-164-23	308
192-472-15	298	194-351-06	305	250-166-35	308
192-472-16	298	194-351-09	305	250-200-01	310
192-487-01	299	194-351-13	305	250-200-02	310
192-487-02	299	194-351-16	305	250-200-03	310
192-487-11	299	194-351-19	305	250-200-04	310
192-487-12	299	194-351-25	305	250-200-05	310
193-440-19	301	194-351-32	305	250-200-06	310
193-465-01	302	194-352-09	306	250-200-07	310
193-465-02	302	194-352-14	306	250-200-08	310
193-465-03	302	194-352-16	306	250-200-09	310
193-465-04	302	194-352-19	306	250-300-00	310
193-472-19	303	194-352-25	306	250-300-01	310
193-476-15	302	194-353-09	306	250-310-50	310
193-477-10	302	194-353-14	306	250-800-01	311
193-477-15	302	194-353-16	306	250-800-02	311
193-477-20	302	194-353-19	306	250-800-10	311
193-477-25	302	194-353-25	306		
193-478-15	302	194-360-10	305		
193-479-15	303	194-360-12	305		
193-480-04	303	194-360-15	305		
193-480-06	303	194-360-25	305		
193-480-08	303	194-361-10	304		
193-481-17	303	194-361-15	304		
193-485-17	303	194-361-20	304		
193-487-17	303	194-361-25	304		
193-488-21	303	194-362-10	305		
193-501-17	301	194-362-12	305		
193-512-16	301	194-362-15	305		
193-512-17	301	194-362-25	305		
193-520-08	301	194-450-06	306		
193-520-10	301	194-450-15	306		
194-300-08	304	194-450-20	306		
194-300-10	304	194-450-25	306		
194-300-12	340	194-450-30	306		
194-300-14	304	194-450-38	306		
194-300-16	304	194-450-44	306		
194-301-08	304	194-450-50	306		
194-301-10	304	194-451-06	306		
194-301-12	304	194-451-15	306		
194-301-14	304	194-451-20	306		
194-301-16	304	194-451-25	306		
194-302-08	304	194-451-30	306		
194-302-10	304	194-451-38	306		
194-302-12	304	194-451-44	306		
194-302-14	304	194-451-50	306		
194-302-16	304	250-130-04	309		
194-318-04	305	250-130-06	309		
194-318-06	305	250-130-08	309		
194-318-08	305	250-130-10	309		
194-318-10	305	250-130-12	309		
194-318-12	305	250-130-15	309		
194-318-14	305	250-133-00	309		
194-319-04	305	250-133-10	309		
194-319-06	305	250-133-20	309		
194-319-08	305	250-133-30	309		
194-319-10	305	250-133-40	309		
194-319-12	305	250-133-50	309		
194-319-14	305	250-133-60	309		
194-334-03	304	250-133-70	309		
194-334-04	304	250-133-80	309		
194-334-05	304	250-133-90	309		
194-334-06	304	250-140-17	309		
194-336-03	304	250-140-25	309		

Index alphanumerisch  
Index alfanumerical



Inhaltsverzeichnis  
Index

ADAIR, UTERINE TENACULUM FORCPES, 19,0 CM	272	BABY-MIXTER DISS.FCPS STR.CVD 14.0 CM	99
ADLERKREUTZ TISSUE FCPS 2 X 3, 15.0 CM	72	BABY-OVERHOLT ART.FORCEPS CVD 13.5 CM	102
ADLERKREUTZ TISSUE FCPS 2 X 3, 20.0 CM	72	BABY-ROUX, RETRACTOR, 13,0 CM	168
ADLERKREUTZ TISSUE FCPS 4 X 5, 15.0 CM	72	BABY-SENN-MILLER RETRACTOR BLOUNT 15.0CM	163
ADLERKREUTZ TISSUE FCPS 4 X 5, 20.0 CM	72	BABY-SENN-MILLER RETRACTOR SHARP 15.0 CM	163
ADSON (CONE) RETRACTOR BLUNT 20.0 CM	193	BABY-TISCHLER FCPS 20 CM WITH FS ROUND CUT	288
ADSON (CONE) RETRACTOR BLUNT 26.0 CM	193	BACKHAUS TOWEL FORCEPS 11,0 CM	86
ADSON (CONE) RETRACTOR SHARP 20.0 CM	193	BACKHAUS TOWEL FORCEPS 13,0 CM	86
ADSON (CONE) RETRACTOR SHARP 26.0 CM	193	BACKHAUS TOWEL FORCEPS 15,0 CM	86
ADSON DRESSING FORCEPS 12,0 CM	66	BACKHAUS TOWEL FORCEPS 8,0 CM	86
ADSON DRESSING FORCEPS 15,0 CM	66	BAINBRIDGE ARTERY FORCEPS CVD 15.0 CM	105
ADSON FCPS WITH TC 12.0 CM	83	BAINBRIDGE ARTERY FORCEPS CVD 18.5 CM	105
ADSON FCPS WITH TC 15.0 CM	83	BAINBRIDGE ARTERY FORCEPS STR 15.0 CM	105
ADSON FORCEPS TC 1X2 TEETH 12,0 CM	83	BAINBRIDGE ARTERY FORCEPS STR 18.5 CM	105
ADSON FORCEPS TC 1X2 TEETH 15,0 CM	83	BAKES GALL DUCT DILATOR ELASTIC, Ø 9.0 MM, 30.0 CM	236
ADSON NEEDLE HOLDER 18.0 CM	125	BAKES GALL DUCT DILATOR FIG.8 30.0 CM ELASTIC, Ø 8.0 MM, 30.0 CM	236
ADSON TISSUE FCPS 1X2 TEETH 15.0 CM	71	BAKES GALL DUCT DILATOR, ELASTIC, Ø 10.0 MM, 30.0 CM	236
ADSON TISSUE FCPS 1X2 TEETH, SERRATED, 12.0 CM	72	BAKES GALL DUCT DILATOR, ELASTIC, Ø 13.0 MM, 30.0 CM	236
ADSON, RASPATORY, FIG. 1, 8 MM, STRAIGHT, 17,0 CM	302	BAKES, GALL DUCT DILATOR ELASTIC, Ø 4.0 MM, 30.0 CM	236
ADSON, RASPATORY, FIG. 2, 7 MM, CURVED, 17,0 CM	302	BAKES, GALL DUCT DILATOR ELASTIC, Ø 3.0 MM, 30.0 CM	236
ADSON, RASPATORY, FIG. 3, 7 MM, STRAIGHT, 17,0 CM	302	BAKES, GALL DUCT DILATOR ELASTIC, Ø 11.0 MM, 30.0 CM	236
ADSON, RASPATORY, FIG. 4, 7 MM, STRONG CURVED, 17,0 CM	302	BAKES, GALL DUCT DILATOR ELASTIC, Ø 12.0 MM, 30.0 CM	236
ADSON, SUCTION TUBE Ø 4.0 MM, 21.0 CM, LUER ATTACHMENT CURVED	223	BAKES, GALL DUCT DILATOR ELASTIC, Ø 2.0 MM, 30.0 CM	236
ADSON, TISSUE FORCEPS 1 X 2 TEETH, 12.0 CM	71	BAKES, GALL DUCT DILATOR ELASTIC, Ø 3.0 MM, 30.0 CM	236
ADSON-BABY, SELF-RETAINING RETRACTOR, BLUNT, 3x4 PRONGS, 16,0 CM	189	BAKES, GALL DUCT DILATOR ELASTIC, Ø 5.0 MM, 30.0 CM	236
ADSON-BABY, SELF-RETAINING RETRACTOR, SHARP, 3x4 PRONGS, 16,0 CM	189	BAKES, GALL DUCT DILATOR ELASTIC, Ø 6.0 MM, 30.0 CM	236
ADSON-BROWN TISS. FCPS STR 7X7 T.12.0 CM	72	BAKES, GALL DUCT DILATOR ELASTIC, Ø 7.0 MM, 30.0 CM	236
ADSON-BROWN TISS. FCPS STR 7X7 T.15.0 CM	72	BALFOUR ABDOMINAL RETRACTOR US-TYPE, 250 MM OPENING	202
ADVENTITIA MICRO SCISSORS SH/SH 14.5 CM	61	BALFOUR EXCHANGEABLE BLADE 100X35 MM	202
ADVENTITIA MICRO SCISSORS SH/SH 15.0 CM	61	BALFOUR EXCHANGEABLE BLADE 45X80 MM	203
ADVENTITIA MICRO SCISSORS SH/SH 18.0 CM	61	BALFOUR EXCHANGEABLE BLADE 70X35 MM	202
ADVENTITIA MICRO SCISSORS SH/SH, SERRATED, 15.0 CM	61	BALFOUR EXCHANGEABLE BLADE 70X85 MM	203
ALAN PARKS ANAL RETRACTOR COMPLETE	253	BALFOUR, ABDOMINAL RETRACTOR, 180 MM, OPENING	202
ALAN PARKS, ANAL RETRACTOR, VALVE 25 X 95 MM	253	BALFOUR, ABDOMINAL RETRACTOR, 200 MM, OPENING	202
ALEXANDER CERV.BIOPSY+SPEC.FCPS 28.0 CM	287	BALFOUR, ABDOMINAL RETRACTOR, 250 MM, OPENING	202
ALEXANDER CHISEL 10MM 18,0CM	305	BALFOUR, EXCHANGEABLE BLADE, 80x90 MM	203
ALEXANDER CHISEL 12MM 18,0CM	305	BALFOUR-BABY ABDOM.RETRACTOR 90MM OPENIN	203
ALEXANDER CHISEL 14MM 18,0CM	305	BARRAQUER, MICRO-NEEDLE HOLDER, STRAIGHT, SERRATED, WITH TC, 14,5 CM	144
ALEXANDER CHISEL 4MM 18,0CM	305	BARRAQUER, MICRO-NEEDLE HOLDER, STRAIGHT, SMOOTH, WITH TC, 14,5 CM	144
ALEXANDER CHISEL 6MM 18,0CM	305	BARRAQUER, MICRO-NEEDLE HOLDER, CURVED, SERRATED, WITH TC, 14,5 CM	144
ALEXANDER CHISEL 8MM 18,0CM	305	BARRAQUER, MICRO-NEEDLE HOLDER, CURVED, SMOOTH, WITH TC, 14,5 CM	144
ALEXANDER, GOUGE, 10MM 18,0CM	305	BARRAQUER, MICRO-NEEDLE HOLDER, W. RATCHET, CURVED, 13,0 CM	130
ALEXANDER, GOUGE, 12MM 18,0CM	305	BARRAQUER-TROUTMAN, MICRO-NEEDLE HOLDER, CURVED, 10,0 CM	130
ALEXANDER, GOUGE, 14MM 18,0CM	305	BARRAQUER-TROUTMAN, MICRO-NEEDLE HOLDER, STRAIGHT, 10,0 CM	130
ALEXANDER, GOUGE, 4MM 18,0CM	305	BARRETT, UTERINE TENACULUM FORCEPS, 18.0CM	272
ALEXANDER, GOUGE, 6MM 18,0CM	305	BARRY STERNAL, WIRE TWISTING FORCEPS WITH TC-INSERTS, 15.0 CM	139
ALEXANDER, GOUGE, 8MM 18,0CM	305	BEACHAM AMNIOTOME 26.0CM	277
ALLEN, INTESTINAL CLAMP, 15,5 CM	242	BECKAMNN-ADSON RETRACTOR SHARP 31.0 CM	194
ALLEN, INTESTINAL CLAMP, 20.0 CM	242	BECKMANN, SELF-RETAINING RETRACTOR 4 X 4 PRONGS, SHARP, 31.0 CM	194
ALLEN, INTESTINAL CLAMP, 23.0 CM	242	BECKMANN, SELF-RETAINING RETRACTOR 4 X 5 PRONGS, BLUNT, 33.0 CM	195
ALLIS AT TISSUE FORCEPS 16.0 CM	242	BECKMANN-ADSON RETRACTOR 25X31MM, BLUNT, 31.0CM	194
ALLIS AT TISSUE SEIZING FCPS, 20.0 CM	242	BECKMANN-ADSON RETRACTOR 25X40 MM, BLUNT, 31. CM	194
ALLIS TISSUE FORCEPS 25,0 CM	242	BECKMANN-ADSON RETRACTOR SHARP 31.0 CM	194
ALLIS, INTESTINAL AND TISSUE GRASPING FORCEPS, 4X5T 15.0CM	242	BECKMANN-ADSON, SELF-RETAINING RETRACTOR 25 X 25 MM, SHARP, 31.0 CM	194
ALLIS, INTESTINAL AND TISSUE GRASPING FORCEPS, 5X6 TEETH, 19.0CM	242	BECKMANN-ADSON, SELF-RETAINING RETRACTOR 25 X 45 MM, SHARP, 31.0 CM	194
ALLIS, INTESTINAL AND TISSUE GRASPING FORCEPS, 5X6T 15.0CM	242	BECKMANN-ADSON, SELF-RETAINING RETRACTOR 25X25 MM, BLUNT, 31.0 CM	194
ALLIS, INTESTINAL AND TISSUE GRASPING FORCEPS, 5X6T 25.0CM	242	BECKMANN-ADSON, SELF-RETAINING RETRACTOR 25X45 MM, BLUNT, 31.0 CM	194
ALLIS, INTESTINAL GRASPING FORCEPS, 20,0 CM	243	BENGOLEA ARTERY FCPS CVD, 1X2T, 26.0 CM	106
ALLIS, TISSUE SEIZING FORCEPS 5 X 6 TEETH, 30.0 CM	242	BENGOLEA ARTERY FCPS STR 1X2T, 26.0 CM	106
ALLIS-ADAIR TIS.SEIZ.FCPS.10X11 15.0 CM	243	BENGOLEA ARTERY FCPS STR. 1X2T, 20.0 CM	106
ALLIS-BABY, INTESTINAL AND TISSUE GRASPING FORCEPS, 4X5 T., 12.5 CM	242	BENGOLEA ARTERY FCPS,CVD, 1X2T, 20.0 CM	106
ALLISON, LUNG SPATULA, 40 MM, 30,0 CM	186	BENGOLEA ARTERY FORCEPS CURVED 26.0 CM	106
ALLISON, LUNG SPATULA, 54 MM, 32,0 CM	186	BENGOLEA ARTERY FORCEPS STRAIGHT 20.0 CM	106
ALM RETRACTOR BLUNT 4X4 PRONGS 10.0 CM	188	BENGOLEA ARTERY FORCEPS STRAIGHT 26.0 CM	106
ALM RETRACTOR BLUNT 4X4 PRONGS 7.0 CM	188	BENGOLEA ARTERY FORCPES CURVED 20.0 CM	106
ALM RETRACTOR SHARP 4X4 PRONGS 10.0 CM	188	BERGMANN MALLETS, 300G, 24,0 CM	306
ALM RETRACTOR SHARP 4X4 PRONGS 7.0 CM	188	BERGMANN PLASTER OF PARIS SHEARS 23.0 CM	44
ALM, RETRACTOR, SEMI-SHARP, 4x4 PRONGS, 10,0 CM	188	BERKELEY, ABDOMINAL RETRACTOR, COMPLETE	203
ALM, RETRACTOR, SEMI-SHARP, 4x4 PRONGS, 7,0 CM	188	BERLIN, TUBING CLAMP, 14,5 CM	91
ANDREW-PINCHON SUCTION TUBE, 24,0 CM	222	BERNHARD TOWEL FORCEPS 16,5 CM	87
ANTHONY, SUCTION TUBE, 26,0 CM	222	BIER, LUMBAR PUNCTURE NEEDLE, Ø 1,6 x 90 MM	225
AUVARD VAG.SPECULA 105 X 38MM	261	BIER, LUMBAR PUNCTURE NEEDLE, Ø 1,8 x 90 MM	225
AUVARD, VAGINAL SPECULA, W. REMOVABLE WEIGHT, 75 X 38 MM	261	BIER, LUMBAR PUNCTURE NEEDLE, Ø 2,1 x 90 MM	225
BABCOCK AT INT.TISSUE FORCEPS 16,0 CM	244	BIER, LUMBAR PUNCTURE NEEDLE, Ø 2,4 x 90 MM	225
BABCOCK AT INT.TISSUE FORCEPS 20,0 CM	244	BIER, LUMBAR PUNCTURE NEEDLE, Ø 2,8 x 90 MM	225
BABCOCK INT.TISS.FCPS TC 16.0 CM	244	BIER, LUMBAR PUNCTURE NEEDLE, Ø 3,0 x 90 MM	225
BABCOCK INT.TISS.FCPS TC 20.0 CM	244	BIRKETT DISS.AND LIG.FCPS. CVD 19.0 CM	103
BABCOCK INT.TISSUE FCPS 16.0 CM	244	BIRKETT DISS.AND LIG.FCPS. STR 19.0 CM	103
BABCOCK INT.TISSUE FCPS 18.0 CM	244	BLADE 23X44 MM	198
BABCOCK INT.TISSUE FCPS 24.0 CM	244	BLADES ONLY, PAIR, FOR ALAN PARKS	253
BABCOCK TISSUE FCPS 20.0 CM	244	BLADES ONLY, PAIR, FOR ALAN PARKS 22 X 95 MM	253
BABY-ADSON ART.FCPS CVD 14.0 CM	108	BLAKE GALL STONE FORCEPS CVD 20.0 CM	233
BABY-ADSON ART.FCPS CVD 18.0 CM	108	BLAKE GALL STONE FORCEPS STR 20.0 CM	233
BABY-DOYEN INT.CLAMP FCPS. CVD.18.0 CM	245	BOETTCHER TONSIL SCISSORS CVD 18.0 CM	36
BABY-DOYEN INT.CLAMPS FCPS. STR.18.0 CM	245	BONNEY TISSUE FORCEPS 1X2 T. TC 18.0 CM	83
BABY-METZENBAUM, DISSEC.-SCS., SUPERCUT, STRAIGHT, BL/BL, 11,0 CM	57	BONNEY TISSUE FORCEPS 1X2 TEETH 18.0 CM	76
BABY-METZENBAUM, DISSEC.-SCS., SUPERCUT, STRAIGHT, BL/BL, 14,5 CM	57	BONNEY TISSUE FORCEPS 2X3 TEETH 18.0 CM	76
BABY-MIKULICZ PERIT.CLAMP-FCPS 14.0 CM	118	BONNEY, DRESSING FORCEPS, 18.0 CM	68
BABY-MIXTER ART.FCPS CVD 18.0 CM	108	BOYS-ALLIS INT.TISS.FCPS 5X6 T. 15.0 CM	243
BABY-MIXTER DISS.FCPS SL.CVD 14.0 CM	99		

BOZEMANN DRESSING FCPS S-SHAPED 26.0 CM	89	BUMM, UTERINE CURETTE, SHARP, RIGID, FIG. 2, Ø 35 MM, 31,0 CM	284
BOZEMANN DRESSING FCPS STRAIGHT 26.0 CM	88	BUMM, UTERINE CURETTE, SHARP, RIGID, FIG. 3, Ø 40 MM, 31,0 CM	284
BOZEMANN LOOP TWISTER 21.0 CM	154	BUNT, SAFETY PIN, 12,0 CM	308
BOZEMANN NEEDLE HOLDER TC S CVD 26.0 CM	139	BURKE FORCEPS, 22,0CM	288
BOZEMANN NEEDLE HOLDER TC S-CVD 20.0 CM	139	BUSCH UMBILICAL SCISSORS 13.0 CM	43
BOZEMANN NEEDLE HOLDER TC S-CVD 24.0 CM	139	BUSCH UMBILICAL SCISSORS 16.0 CM	43
BOZEMANN, GYN.-SCS, S-SHAPED, BL/BL, 22.0 CM	40	BYRD SUCTION TUBE 15 CM 2.5MM	223
BRAITHWAITE, DERMATOMES, SPARE BLADE ONLY	11	BYRD SUCTION TUBE 15.0CM 1.5MM	223
BRAITHWAITE, DERMATOMES, 30.0 CM	11	BYRD SUTION TUBE 15 CM 3.5 MM	223
BRAUN MODIF., VAGINAL SPECULA, 85X17 MM	268	CAMPBELL TROCAR 16.0 CM 6 MM	220
BRAUN, UTERINE DEPRESSOR, 28.0 CM	277	CAMPBELL TROCAR 16.0 CM 8 MM	220
BRAUN, UTERINE TENACULUM FORCEPS, 4X4 TEETH, 15,5 CM	275	CANNULA FOR VAGINAL ANEASTHESIA, Ø 1,0 x 185 MM	224
BRAUN, UTERINE TENACULUM FORCEPS, 25,0 CM	273	CANNULA, Ø 1,2 x 80 MM	225
BRAUN-STADLER EPISIOTOMY SCS 22.0 CM	43	CANNULA, Ø 1,5 x 80 MM	225
BRAUN-STADLER EPISIOTOMY SCS 14.0 CM	43	CANNY RYAL, RETRACTOR, 16 MM, 19,0 CM	169
BREISKY VAG.SPEC.BAYONET SH.100X20 MM	268	CANNY RYAL, RETRACTOR, 20 MM, 19,0 CM	169
BREISKY VAG.SPEC.BAYONET SH.100X25 MM	268	CANNY RYAL, RETRACTOR, 25 MM, 20,0 CM	169
BREISKY VAG.SPEC.BAYONET SH.100X30 MM	268	CAPLAN NASAL SCISSORS CURVED 22.0 CM	35
BREISKY VAG.SPEC.BAYONET SH.100X35 MM	268	CARREL ARTERY FORCEPS STR 10.0 CM	98
BREISKY VAG.SPEC.BAYONET SH.100X40 MM	268	CARTILAGE SCISS.SAW EDGE 20.0 CM	36
BREISKY VAG.SPEC.BAYONET SH.130X20 MM	268	CARTILAGE, RESECTION KNIVES, WITH DISSECTOR END, 17.5 CM	10
BREISKY VAG.SPEC.BAYONET SH.130X25 MM	268	CASTROVIEJO, MICRO-NEEDLEHOLDER, W. RATCHET, SERRATED, CURVED, 14,5 CM	131
BREISKY VAG.SPEC.BAYONET SH.130X30 MM	268	CASTROVIEJO, MICRO-NEEDLEHOLDER, W. RATCHET, SERRATED, STRAIGHT, 14,5 CM	131
BREISKY VAG.SPEC.BAYONET SH.130X35 MM	268	CASTROVIEJO, MICRO-NEEDLEHOLDER, W. RATCHET, SERRATED, STRAIGHT, 18,0 CM	131
BREISKY VAG.SPEC.BAYONET SH.130X40 MM	268	CASTROVIEJO, MICRO-NEEDLEHOLDER, W. RATCHET, SERRATED, STRAIGHT, 18,0 CM	131
BREISKY VAG.SPEC.BAYONET SH.155X40 MM	268	CASTROVIEJO, MICRO-NEEDLEHOLDER, W. RATCHET, SMOOTH, CURVED, 14,5 CM	131
BRODIE, DIRECTOR (PROBE), GROOVED, WITH BUTTON, 20.0 CM	214	CASTROVIEJO, MICRO-NEEDLEHOLDER, W. RATCHET, SMOOTH, CURVED, 18,0 CM	131
BROPHY (SULLIVAN), FINE SCISSORS STRAIGHT 14.5 CM	31	CASTROVIEJO, MICRO-NEEDLEHOLDER, W. RATCHET, SMOOTH, STRAIGHT, 14,5 CM	131
BROPHY (SULLIVAN), FINE SCISSORS CURVED 14.5 CM	31	CASTROVIEJO, MICRO-NEEDLEHOLDER, W. RATCHET, SMOOTH, STRAIGHT, 18,0 CM	131
BROPHY DRESSING FORCEPS CVD 20,0 CM	68	CASTROVIEJO, MICRO-NEEDLEHOLDER, W. RATCHET, SMOOTH, STRAIGHT, 18,0 CM	131
BROPHY DRESSING FORCEPS STR 20.0 CM	67	CASTROVIEJO, NEEDLE HOLDER W. TC, CVD., SERRATED, 14,0 CM	144
BROPHY TISSUE FCPS 1X2 T CVD 20,0 CM	74	CASTROVIEJO, NEEDLE HOLDER W. TC, CVD., SERRATED, 18,0 CM	144
BROPHY TISSUE FCPS 1X2 T STR 20,0 CM	74	CASTROVIEJO, NEEDLE HOLDER W. TC, CVD., SMOOTH, 18,0 CM	144
BROWN NEEDLE HOLDER 13.0 CM	125	CASTROVIEJO, NEEDLE HOLDER W. TC, STR., SERRATED, 14,0 CM	144
BROWN TISSUE FORCEPS 15.0 CM	76	CASTROVIEJO, NEEDLE HOLDER W. TC, STR., SMOOTH, 14,0 CM	144
BROWN TISSUE FORCEPS 20.0 CM	76	CASTROVIEJO, NEEDLE HOLDER W. TC, STR., SMOOTH, 18,0 CM	144
BROWN TISSUE FORCEPS 25.0 CM	76	CASTROVIEJO, NEEDLE HOLDER W. TC, STR., WITH RATCHET, SERRATED, 18,0 CM	144
BRUNNER LIGATURE CONDUCTOR FIG.1 30.0 CM	151	CATLIN, AMPUTATING KNIFE, BLADE LENGTH 16,0 CM	8
BRUNNER LIGATURE CONDUCTOR FIG.2 30.0 CM	151	CATLIN, AMPUTATING KNIFE, BLADE LENGTH 19,0 CM	8
BRUNNER LIGATURE CONDUCTOR LEFT 30.0 CM	151	CATLIN, AMPUTATING KNIFE, BLADE LENGTH 22,0 CM	8
BRUNNER LIGATURE CONDUCTOR RIGHT 30.0 CM	151	CHAIN WITH WEIGHT, 645 G, FOR DOYEN RETRACTOR	209
BRUNNER LIGATURE NEEDLE 25.0 CM	148	CHAPUT ARTERY FORCEPS 3X2 TEETH 13.0 CM	96
BRUNNER LIGATURE NEEDLE FIG 1 30.0 CM	148	CHEATLE STERILIZING FORCEPS 27,0 CM	308
BRUNNER LIGATURE NEEDLE FIG.2 30.0 CM	148	CHELSEA EATON, ANOSCOPE, Ø 22 x 65 mm	254
BRUNNER RETRACTOR 100X20 MM 25.0 CM	184	CHELSEA EATON, ANOSCOPE, Ø 30 x 65 MM	254
BRUNNER RETRACTOR 120X25 MM 25.0 CM	184	CHERON DRESSING FORCEPS 25.0 CM	89
BRUNNER RETRACTOR 140X25 MM 25.0 CM	184	CHILDE SUTURE FORCEPS 18.0 CM	155
BRUNNER RETRACTOR 160X30 MM 25.0 CM	184	CHILDE SUTURE FORCEPS CLIP 18.0 CM	155
BRUNNER RETRACTOR 180X30 MM 25.0 CM	184	CHISEL, 10MM 13,5CM	304
BRUNNER RETRACTOR 80X20 MM 25.0 CM	184	CHISEL, 12MM 13,5CM	304
BRUNNER, INTESTINAL CLAMP FORCEPS, 24.0 CM	248	CHISEL, 14MM 13,5CM	304
BRUNNER, INTESTINAL CLAMP FORCEPS, WITH NON-TRAUMATIC SERRATION, 24,0 CM	248	CHISEL, 16MM 13,5CM	304
BRUNNER, RETRACTOR, FLAT FINGER-RING-HANDLE, 100X20 MM 25.0 CM	183	CHISEL, 8MM 13,5CM	304
BRUNNER, RETRACTOR, FLAT FINGER-RING-HANDLE, 120X25 MM 25.0 CM	183	CIRCUMCISION INSTRUMENT 8 MM BABY SIZE	240
BRUNNER, RETRACTOR, FLAT FINGER-RING-HANDLE, 140X25 MM 25.0 CM	183	CIRCUMCISION INSTRUMENT 11 MM CHILD SIZE	240
BRUNNER, RETRACTOR, FLAT FINGER-RING-HANDLE, 160X30 MM 25.0 CM	183	CIRCUMCISION INSTRUMENT 13 MM CHILD SIZE	240
BRUNNER, RETRACTOR, FLAT FINGER-RING-HANDLE, 180X30 MM 25.0 CM	183	CIRCUMCISION INSTRUMENT 16 MM ADOL.SIZE	240
BRUNNER, RETRACTOR, FLAT FINGER-RING-HANDLE, 80X20 MM 25.0 CM	183	CIRCUMCISION INSTRUMENT 21 MM ADOL.SIZE	240
BRUNNER-FERROZELL LIGATURE CONDUCT. 18CM	153	CIRCUMCISION INSTRUMENT 26 MM MEN'S SIZE	240
BRUNNER-FERROZELL LIGATURE CONDUCT. 27CM	153	CIRCUMCISION INSTRUMENT 32 MM MEN'S SIZE	240
BRUNS BONE CURETTE, FIG.0	298	CLAMP 18.0 CM WITH CLIP	91
BRUNS BONE CURETTE, FIG.00	298	CLAUS LIGATURE NEEDLE 23.0 CM	150
BRUNS BONE CURETTE, FIG.000	298	CLAUS-EICKEN LIGATURE NEEDLE 23.0 CM	150
BRUNS BONE CURETTE, FIG.0000	298	COAKLEY ANTRUM TROCAR SET 2.25 MM	220
BRUNS BONE CURETTE, FIG.1	298	COGSWELL, SUCTION TUBE, 23,0 CM, Ø 2,0 MM	222
BRUNS BONE CURETTE, FIG.2	298	COHEN, INTRA-UTERINE PROBE, COMPLETE WITH 2 INSERTS	269
BRUNS BONE CURETTE, FIG.3	298	COLLIER NEEDLE HOLDER 12.5 CM	124
BRUNS BONE CURETTE, FIG.4	298	COLLIN ABDOMINAL RETRACTOR 22.0 CM LATERAL BLADES: 38X80MM	199
BRUNS BONE CURETTE, FIG.5	298	CENTRAL BLADES: 55X65MM	199
BRUNS BONE CURETTE, FIG.6	298	COLLIN ABDOMINAL RETRACTOR 22.0 CM LATERAL VALVES: 38X100MM	199
BRUNS PL.-OF-PARIS SHEARS 24.0 CM SMOOTH	45	CENTRAL BLADES: 55X75MM	199
BRUNS PLASTER-OF-PARIS SHEARS 24.0CM SAW	45	COLLIN AMPUTATING KNIFE, BLADE LENGTH 13,0 CM	8
BRUNS, BANDAGE SCISSORS TC, 24.0 CM	55	COLLIN CLIP FORCEPS 13.0 CM	154
BRUSH DISPENSER FOR 10 BRUSHES	311	COLLIN DRESSING FORCEPS 24.0 CM	89
BRUSH DISPENSER FOR 20 BRUSHES	311	COLLIN SEIZING FCPS OVAL 16.0 CM	96
BRYANT, SPONGE AND DRESSING FCPS., 13.0 CM	88	COLLIN VAG.SPECULUM 100 X 35 MM	258
BUCK LIGATURE SCISSORS 14.5 CM	33	COLLIN VAG.SPECULUM 110 X 40 MM	258
BUCK LIGATURE SCISSORS 18.0 CM	33	COLLIN VAG.SPECULUM 85 X 30 MM	258
BUELAU TROCAR 24.0 CM 8 MM	219	COLLIN, ABDOMINAL RETRACTOR COMPL. LATERAL VALVES 32 X 62 MM,	199
BUMM, UTERINE CURETTE, BLUNT, MALLEABLE, FIG. 1, Ø 30 MM, 31,0 CM	285	SPRIDING WIDE 135 X 160 MM, 23.5 CM	199
BUMM, UTERINE CURETTE, BLUNT, MALLEABLE, FIG. 2, Ø 35 MM, 31,0 CM	285	COLLIN, ABDOMINAL RETRACTOR, VALVE ONLY, 100X38 MM	200
BUMM, UTERINE CURETTE, BLUNT, MALLEABLE, FIG. 3, Ø 40 MM, 31,0 CM	285		
BUMM, UTERINE CURETTE, BLUNT, RIGID, FIG. 1, Ø 30 MM, 31,0 CM	285		
BUMM, UTERINE CURETTE, BLUNT, RIGID, FIG. 2, Ø 35 MM, 31,0 CM	285		
BUMM, UTERINE CURETTE, BLUNT, RIGID, FIG. 3, Ø 40 MM, 31,0 CM	285		
BUMM, UTERINE CURETTE, SHARP, MALLEABLE, FIG. 1, Ø 30 MM, 31,0 CM	284		
BUMM, UTERINE CURETTE, SHARP, MALLEABLE, FIG. 2, Ø 35 MM, 31,0 CM	284		
BUMM, UTERINE CURETTE, SHARP, MALLEABLE, FIG. 3, Ø 40 MM, 31,0 CM	284		
BUMM, UTERINE CURETTE, SHARP, RIGID, FIG. 1, Ø 30 MM, 31,0 CM	284		

Inhaltsverzeichnis  
Index

COLLIN, ABDOMINAL RETRACTOR, VALVE ONLY, 55X55 MM	200	CUSHING RECTRACTOR 18 MM 20.0 CM	165
COLLIN, ABDOMINAL RETRACTOR, VALVE ONLY, 55X65 MM	200	CUSHING RECTRACTOR 8 MM 20.0 CM	165
COLLIN, ABDOMINAL RETRACTOR, VALVE ONLY, 55X75 MM	200	CUSHING RECTRACTOR 10MM 24.0 CM	165
COLLIN, ABDOMINAL RETRACTOR, VALVE ONLY, 58X50 MM	200	CUSHING RECTRACTOR 12 MM 24.0 CM	165
COLLIN, ABDOMINAL RETRACTOR, VALVE ONLY, 62X38 MM	200	CUSHING RECTRACTOR 14 MM 24.0 CM	165
COLLIN, ABDOMINAL RETRACTOR, VALVE ONLY, 80X38 MM	200	CUSHING RECTRACTOR 16 MM 24.0 CM	165
COLLIN, ABDOMINAL RETRACTOR, VALVE ONLY, 80X60 MM	200	CUSHING RECTRACTOR 18 MM 24.0 CM	165
COLLIN, ABDOMINAL RETRACTOR, VALVE ONLY, 85X72 MM	200	CUSHING RECTRACTOR 8 MM 24.0 CM	165
COLLIN, AMPUTATING KNIFE, BLADE LENGTH 22,0 CM	8	CUSHING SPINAL RETRACTORS, 20,0 CM	166
COLLIN, AMPUTATING KNIFE, BLADE LENGTH 28,0 CM	8	CUSHING TISSUE FORCEPS CVD 1X2 T.17.5 CM	74
COLLIN, AMPUTATING KNIFE, HOLLOW HANDLE, FIG.1	8	CUSHING TISSUE FORCEPS STR 1X2 T. 17.5CM	74
COLLIN, AMPUTATING KNIFE, BLADE LENGTH, 19,0 CM	8	CUSHING, NERVE HOOK, FIG. 1 4 MM, 19,0 CM	161
COLLIN, MALLETS STEEL SOLID, Ø30,0 MM, 220G, 20,0 CM	306	CUSHING, NERVE HOOK, FIG. 2 6 MM, 19,0 CM	161
COLLIN, OPERATING KNIFE, HOLLOW HANDLE, FIG.1	6	CUSHING-TAYLOR FCPS.TC 18.0 CM	83
COLLIN, OPERATING KNIFE, HOLLOW HANDLE, FIG.2	6	CYLINDER ONLY, INSULINE SYRINGE, LUER, 1 ML	227
COLLIN, OPERATING KNIFE, HOLLOW HANDLE, FIG.3	6	CYLINDER ONLY, INSULINE SYRINGE, LUER, 2 ML	227
COLLIN, OPERATING KNIFE, HOLLOW HANDLE, FIG.4	6	CYLINDER ONLY, JANET, WOUND A. BLADDER SYRINGE, 100 ML	228
COLLIN, OPERATING KNIFE, HOLLOW HANDLE, FIG.5	6	CYLINDER ONLY, JANET, WOUND A. BLADDER SYRINGE, 150 ML	228
COLLIN, OPERATING KNIFE, HOLLOW HANDLE, FIG.6	6	CYLINDER ONLY, JANET, WOUND A. BLADDER SYRINGE, 200 ML	228
COLLIN, UTERINE ELEVATING FORCEPS, 25,0 CM	277	CYLINDER ONLY, JANET, WOUND A. BLADDER SYRINGE, ONLY 50 ML	228
COLLIN, UTERINE PROBE, Ø 4 MM, 28,0 CM	277	CYLINDER ONLY, SYRINGE LUER, 1 ML	227
COLLIN, VAGINAL SPECULA F. CHILDREN, 65 X 10 MM	258	CYLINDER ONLY, SYRINGE LUER, 10 ML	227
COLLIN, VAGINAL SPECULA F. VIRGINS, 65 x 20 MM	258	CYLINDER ONLY, SYRINGE LUER, 2 ML	227
COLLIN-BABY ABDOMINAL RETRACTOR COMPLETE	198	CYLINDER ONLY, SYRINGE LUER, 20 ML	227
COLLIN-DUVAL GRASPING FCPS 20,0 CM/14 MM	75	CYLINDER ONLY, SYRINGE LUER, 5 ML	227
COLLIN-DUVAL GRASPING FCPS 20,0 CM/18 MM	75	CYLINDER ONLY, SYRINGE LUER, 50 ML	227
COLLIN-DUVAL GRASPING FCPS 20,0 CM/27 MM	75	CYLINDER ONLY, SYRINGE, LUER-LOCK, 1 ML	227
CONE LARGE, ONLY	269	CYLINDER ONLY, SYRINGE, LUER-LOCK, 10 ML	227
CONE SMALL, ONLY	269	CYLINDER ONLY, SYRINGE, LUER-LOCK, 10 ML	228
CONNECTING PIECE, LUER-LOCK FEMALE	229	CYLINDER ONLY, SYRINGE, LUER-LOCK, 2 ML	227
CONNECTING PIECE, LUER-LOCK MALE, Ø 6 MM	229	CYLINDER ONLY, SYRINGE, LUER-LOCK, 20 ML	227
CONNECTING PIECE, LUER-LOCK MALE, Ø 8 MM	229	CYLINDER ONLY, SYRINGE, LUER-LOCK, 20 ML	228
CONNECTING PIECE, LUER-LOCK, FEMALE	229	CYLINDER ONLY, SYRINGE, LUER-LOCK, 30 ML	228
CONNECTING PIECE, LUER-LOCK, MALE	229	CYLINDER ONLY, SYRINGE, LUER-LOCK, 5 ML	227
CONNECTING PIECE, LUER-LOCK, MALE	229	CYLINDER ONLY, SYRINGE, LUER-LOCK, 50 ML	227
COOLEY SUCTION TUBE 30,0 CM, Ø 7,0 MM	222	CYLINDER ONLY, SYRINGE, LUER-LOCK, 50 ML	228
COOLEY SUCTION TUBE 31,0 CM, Ø 10,0 MM	222	CYLINDER ONLY, TUBERCULINE SYRINGE, LUER-LOCK, 1ML	228
COOLEY SUCTION TUBE 33,0 CM, Ø 8,0 MM	222	CZERNY, GALL STONE FORCEPS, 24,5 CM	233
COOLEY SUCTION TUBE 35,0 CM, Ø 8,0 MM	222	CZERNY, RETRACTOR, DOUBLE-ENDED, SOLID/ 2 PRONG BLUNT, 17,5 CM	168
COOPER LIGATURE NEEDLE 19,0 CM	147	CZERNY, UTERINE TENACULUM FORCEPS, 4X4 TEETH, 20,5 CM	275
COOPER LIGATURE NEEDLE 20,0 CM	147	DANDY NEUROSURGICAL SCISSORS 17,0 CM	34
CORONARY SCISSORS 11,5 CM	39	DANDY ARTERY FCPS CVD 1X2 T. 14,0 CM	102
CORYLLOS RETRACTOR 115X60 MM 24.0 CM	182	DARTIGUES UTER.ELEVATING FORCEPS 27.0 CM	276
CORYLLOS RETRACTOR 82X22 MM 24.0 CM	182	DAUBENSPECK, BONE CURETTE, FIG. 0, 20,0 CM	299
CORYLLOS RETRACTOR 82X22 MM 24.0 CM	182	DAUBENSPECK, BONE CURETTE, FIG. 00, 20,0 CM	299
COTTLE NASAL SCISSORS BLUNT 16,0 CM	35	DAUBENSPECK, BONE CURETTE, FIG. 1, 20,0 CM	299
COTTLE, NASAL SCS., SUPER CUT, BL/BL, 16,5 CM	58	DAUBENSPECK, BONE CURETTE, FIG. 2, 20,0 CM	299
COUPLAND, EXCHANGEABLE SUCTION TUBE, Ø 3,5 MM	222	DAVIDSON RETRACTOR 75X50 MM 16.0 CM	186
COUPLAND, HANDLE FOR SUCTION TUBE, 17,0 CM	222	DAVIDSON RETRACTOR 75X90 MM 16.0 CM	186
CRAFOORD ARTERY FORCEPS CVD 24,0 CM	104	DE BAKEY ARTERY SCISSORS 15.5 CM	38
CRAFOORD LOBECTOMY SCS CVD BL 30,0 CM	39	DE BAKEY ARTERY SCISSORS 15.5 CM	38
CRAFOORD-SELLORS BRONCHUS FORCEPS 22.0CM	115	DE BAKEY ATRAUMA BULLD.CLAMP CVD 10.0 CM	95
CRAFOORD-SELLORS BRONCHUS FORCEPS 23.0CM	115	DE BAKEY ATRAUMA BULLD.CLAMP CVD 11.5 CM	95
CRAFOORD-SELLORS BRONCHUS FORCEPS 24.0CM	115	DE BAKEY ATRAUMA BULLDOG CLAMP STRAIGHT, 10,5 CM	95
CRILE ARTERY FORCEPS CVD 1X2 T. 14,0 CM	102	DE BAKEY ATRAUMA BULLDOG CLAMP STRAIGHT, 12,0 CM	95
CRILE ARTERY FORCEPS STR 1X2 T. 14,0 CM	102	DE BAKEY ATRAUMA BULLDOG CLAMP STRAIGHT, 7,5 CM	95
CRILE FORCEPS CURVED 14,0 CM	102	DE BAKEY ATRAUMA BULLDOG CLAMP STRAIGHT, 8,5 CM	95
CRILE FORCEPS STR 14,0 CM	102	DE BAKEY ATRAUMA BULLDOG CLAMP CVD 7.0CM	95
CRILE-MURRAY, NEEDLE HOLDER, 15,0 CM	125	DE BAKEY ATRAUMA BULLDOG CLAMP CVD 8.0CM	95
CRILE-RANKIN, ARTERY FORCEPS, 1X2 TEETH, CVD., 16,0 CM	103	DE BAKEY ATRAUMA FCPS ANGLED 1.5 MM 20.0 CM	81
CRILE-RANKIN, ARTERY FORCEPS, 1X2 TEETH, STR., 16,0 CM	103	DE BAKEY ATRAUMA FCPS ANGLED 1.5 MM 24.0 CM	81
CRILE-RANKIN, ARTERY FORCEPS, CVD, 16,0 CM	103	DE BAKEY ATRAUMA FCPS ANGLED 1.5 MM 30.0 CM	81
CRILE-RANKIN, ARTERY FORCEPS, STR, 16,0 CM	103	DE BAKEY ATRAUMA FCPS CVD 2.0 MM 24.0 CM	81
CRILE-WOOD NEEDLE HOLDER 15,0 CM	125	DE BAKEY ATRAUMA FCPS CVD 2.0 MM 30.0 CM	81
CRILE-WOOD NEEDLE HOLDER TC 15,0 CM	134	DE BAKEY ATRAUMA FCPS CVD 2.0MM 16.0 CM	81
CRILE-WOOD NEEDLE-HOLDER TC 18,0 CM	134	DE BAKEY ATRAUMA FCPS CVD 2.0MM 20.0 CM	81
CUSCO VAG.SPEC.W.CENTR.RAT.100X37 MM	259	DE BAKEY ATRAUMA FCPS STR 1.5 MM 24.0 CM	81
CUSCO VAG.SPECULUM SWISS PATT.100X25 MM	259	DE BAKEY ATRAUMA FCPS STR 1.5 MM 30.0 CM	81
CUSCO VAG.SPECULUM SWISS PATT.105X27 MM	259	DE BAKEY ATRAUMA FCPS STR 2,4MM 24.0 CM	81
CUSCO VAG.SPECULUM SWISS.PATT. 80X22 MM	259	DE BAKEY ATRAUMA FCPS STR 2,4MM 30.0 CM	81
CUSCO VAG.SPECULUM W.CENTR.RAT.74X32 MM	259	DE BAKEY ATRAUMA FCPS STR 2,8 MM 16.0 CM	81
CUSCO VAG.SPECULUM W.CENTR.RAT.85X35 MM	259	DE BAKEY ATRAUMA FCPS STR 2,8 MM 20.0 CM	81
CUSCO VAGINAL SPECULUM 100X35 MM	259	DE BAKEY ATRAUMA FCPS STR 2,8 MM 24.0 CM	81
CUSCO VAGINAL SPECULUM 75X32 MM	259	DE BAKEY ATRAUMA FCPS STR 2,8 MM 30.0 CM	81
CUSCO VAGINAL SPECULUM 85X35 MM	259	DE BAKEY ATRAUMA FCPS STR 2,8 MM 24.0 CM	81
CUSCO VAGINAL SPECULUM VIRGIN S.75X17 MM	259	DE BAKEY ATRAUMA FCPS STR 2,8 MM 30.0 CM	81
CUSCO, VAGINAL SPECULA, 105 x 25 MM	258	DE BAKEY ATRAUMA FCPS STR 3,5 MM 16.0 CM	81
CUSCO, VAGINAL SPECULA, 107 x 29 MM	258	DE BAKEY ATRAUMA FCPS STR 3,5 MM 16.0 CM	81
CUSCO, VAGINAL SPECULA, 115 x 35 MM	258	DE BAKEY ATRAUMA FCPS STR 3,5 MM 20.0 CM	81
CUSCO, VAGINAL SPECULA, 80 x 24 MM	258	DE BAKEY ATRAUMA FCPS STR 3,5 MM 20.0 CM	81
CUSCO, VAGINAL SPECULA, 80 x 32 MM	258	DE BAKEY ATRAUMA FCPS STR 3,5 MM 24.0 CM	81
CUSCO, VAGINAL SPECULA, 98 x 16 MM	258	DE BAKEY ATRAUMA FCPS STR 3,5 MM 24.0 CM	81
CUSHING DRESSING FORCEPS CVD 17.5 CM	67	DE BAKEY ATRAUMA FCPS STR 3,5 MM 30.0 CM	81
CUSHING DRESSING FORCEPS STR 17.5 CM	67	DE BAKEY ATRAUMA FCPS STR 3,5 MM 30.0 CM	81
CUSHING FCPS TC 17.5 CM	83	DE BAKEY ATRAUMA FCPS.ANGLED 1,5 MM 16.0 CM	81
CUSHING FCPS TC CVD 17.5 CM	83	DE BAKEY NEEDLE HOLDER TC 18.0 CM	136
CUSHING RECTRACTOR 10 MM 20.0 CM	165	DE BAKEY NEEDLE HOLDER TC 20.0 CM	136
CUSHING RECTRACTOR 12 MM 20.0 CM	165	DE BAKEY NEEDLE HOLDER TC 23.0 CM	136
CUSHING RECTRACTOR 14 MM 20.0 CM	165	DE BAKEY NEEDLE HOLDER TC 26.0 CM	136
CUSHING RECTRACTOR 16 MM 20.0 CM	165	DE BAKEY NEEDLE HOLDER TC 31.0 CM	136

DE BAKEY NEEDLE HOLDER TC 37.0 CM	136	DELICATE HOOK FIG.4 16.0 CM	159
DE BAKEY, SUCTION TUBE, 27,0 CM	222	DENNIS-BROWN, DRESSING FORCEPS, 20,0 CM	68
DE BAKEY, VASCULAR FORCEPS, ATRAUMATIC Ø 1.5 MM, 16,0 CM	81	DENNIS-BROWNE, ABDOMINAL RETRACTOR, COMPLETE	205
DE BAKEY, VASCULAR FORCEPS, ATRAUMATIC Ø 1.5 MM, 20,0 CM	81	DENNIS-BROWNE, ABDOMINAL RETRACTOR, FRAME ONLY	205
DE BAKEY, VASCULAR FORCEPS, ATRAUMATIC Ø 2.0 MM, 16,0 CM	81	DENNIS-BROWNE, ABDOMINAL RETRACTOR, VALVES ONLY, 40X30 MM	205
DE BAKEY, VASCULAR FORCEPS, ATRAUMATIC Ø 2.0 MM, 20,0 CM	81	DENNIS-BROWNE, ABDOMINAL RETRACTOR, VALVES ONLY, 40X40 MM	205
DE BAKEY, VASCULAR FORCEPS, ATRAUMATIC Ø 2.4 MM, 16,0 CM	81	DERF NEEDLE HOLDER 12.0 CM	124
DE BAKEY, VASCULAR FORCEPS, ATRAUMATIC Ø 2.4 MM, 20,0 CM	81	DERF, NEEDLE HOLDER, WITH TC, 12,0 CM	133
DE BAKEY, VASCULAR FORCEPS, ATRAUMATIC Ø 2.8 MM, 16,0 CM	81	DERF-CONVERSE NEEDLE HOLDER 12.5 CM	124
DE BAKEY, VASCULAR FORCEPS, ATRAUMATIC Ø 2.8 MM, 20,0 CM	81	DESCHAMPS NEEDLE LEFT BLUNT MEDIUM 20 CM	146
DE BAKEY, VASCULAR FORCEPS, ATRAUMATIC STR Ø 2.0MM 24.0 CM	81	DESCHAMPS NEEDLE LEFT BLUNT SMALL 20.0CM	146
DE BAKEY, VASCULAR FORCEPS, ATRAUMATIC STR Ø 2.0MM 30.0 CM	81	DESCHAMPS NEEDLE LEFT BLUNT WIDE 21.0 CM	147
DE BAKEY, VASCULAR SCISSORS WITH TC-INSERTS 45° ANGLED, 18,0 CM	53	DESCHAMPS NEEDLE LEFT BLUNT WIDE 27.0 CM	147
DE BAKEY, VASCULAR SCISSORS WITH TC-INSERTS 45° ANGLED, 23,0 CM	53	DESCHAMPS NEEDLE LEFT RIGHT WIDE 21.0 CM	147
DE BAKEY, VASCULAR SCISSORS WITH TC-INSERTS, 25° ANGLED, 18,0 CM	53	DESCHAMPS NEEDLE LEFT SHARP MEDIUM 20 CM	146
DE BAKEY, VASCULAR SCISSORS WITH TC-INSERTS, 25° ANGLED, 23,0 CM	53	DESCHAMPS NEEDLE LEFT SHARP WIDE 21.0 CM	147
DE BAKEY, VASCULAR SCISSORS, 25°, 16,0 CM	36	DESCHAMPS NEEDLE LEFT SHARP WIDE 27.0 CM	147
DE BAKEY, VASCULAR SCISSORS, 25°, 19,0 CM	36	DESCHAMPS NEEDLE RIGHT BLUNT MED 20.0 CM	146
DE BAKEY, VASCULAR SCISSORS, 25°, 21,0 CM	36	DESCHAMPS NEEDLE RIGHT BLUNT SMALL 20 CM	146
DE BAKEY, VASCULAR SCISSORS, 25°, 23,0 CM	36	DESCHAMPS NEEDLE RIGHT BLUNT WIDE 21.0CM	147
DE BAKEY, VASCULAR SCISSORS, 25°, 28,0 CM	36	DESCHAMPS NEEDLE RIGHT BLUNT WIDE 27.0CM	147
DE BAKEY, VASCULAR SCISSORS, 45°, 16,0 CM	36	DESCHAMPS NEEDLE RIGHT SHARP MED 20.0 CM	146
DE BAKEY, VASCULAR SCISSORS, 45°, 19,0 CM	36	DESCHAMPS NEEDLE RIGHT SHARP WIDE 27.0CM	147
DE BAKEY, VASCULAR SCISSORS, 45°, 21,0 CM	36	DESCHAMPS, LIGATURE NEEDLE FOR RIGHT HAND, SMALL CURVED SHARP, 20,0 CM	146
DE BAKEY, VASCULAR SCISSORS, 45°, 23,0 CM	36	DESCHAMPS, LIGATURE NEEDLE FOR THE LEFT HAND, SMALL CURVED SHARP, 20,0 CM	146
DE BAKEY, VASCULAR SCISSORS, 45°, 28,0 CM	36	DESJARDINS GALL DUCT CLAMP 21,0 CM	114
DE BAKEY, VASCULAR SCISSORS, 60°, 16,0 CM	36	DESJARDINS GALL STONE FCPS.23.0 CM FIG.1	232
DE BAKEY, VASCULAR SCISSORS, 60°, 19,0 CM	36	DESJARDINS GALL STONE FCPS.23.0 CM FIG.2	232
DE BAKEY, VASCULAR SCISSORS, 60°, 21,0 CM	36	DESJARDINS, GALL STONE PROBE, FIG. 1, 28,0 CM	235
DE BAKEY, VASCULAR SCISSORS, 60°, 23,0 CM	36	DESJARDINS, GALL STONE PROBE, FIG. 2, 28,0 CM	235
DE BAKEY, VASCULAR SCISSORS, 60°, 28,0 CM	36	DESJARDINS, GALL STONE PROBE, FIG. 3, 28,0 CM	235
DE BAKEY, VASCULAR SCISSORS, WITH TC-INSERTS 60° ANGLED, 18,0 CM	53	DESJARDINS, GALL STONE SCOOP, ELASTIC, FIG. 1, Ø 6 MM/18 CHAR., 28,0 CM	235
DE BAKEY, VASCULAR SCISSORS, WITH TC-INSERTS 60° ANGLED, 23,0 CM	53	DESJARDINS, GALL STONE SCOOP, ELASTIC, FIG. 2, Ø 7.0 MM/ 21 CHAR., 28,0 CM	235
DE LA ROZA LIGATURE NEEDLE LEFT 12.0 CM	149	DESJARDINS, GALL STONE SCOOP, ELASTIC, FIG. 3, Ø 8.0 MM/ 24 CHAR., 28,0 CM	235
DE LA ROZA LIGATURE NEEDLE RIGHT 12.0 CM	149	DESJARDINS, GALL STONE SCOOP, ELASTIC, FIG. 4, Ø 9.0 MM/ 27 CHAR., 28,0 CM	235
DE LEE, OBSTETRICAL FORCEPS, 30,0CM	289	DESMARRES RETRACTOR 10 MM 16.0 CM	164
DE LEE, OBSTETRICAL FORCEPS, 36, 0 CM	289	DESMARRES RETRACTOR 12 MM 16.0 CM	164
DE LEE, OBSTETRICAL FORCEPS, 38, 0 CM	289	DESMARRES RETRACTOR 14 MM 16.0 CM	164
DE MARTEL-WOLFSON CLAMP CLOS.FCPS 26.0CM	249	DESMARRES RETRACTOR 16 MM 16.0 CM	164
DE MARTEL-WOLFSON CLAMP HOLDER 8,5 CM	249	DESMARRES RETRACTOR 18 MM 16.0	164
DE MARTEL-WOLFSON COLON-ANASTOMOSIS CLAMP FORCEPS, SET W. 3 PCS., 10 CM	249	DESMARRES RETRACTOR 8 MM 16.0 CM	164
DE MARTEL-WOLFSON COLON-ANASTOMOSIS CLAMP FORCEPS, SET W. 3 PCS., 5 CM	249	DESMARRES, RETRACTOR 10.0 MM, 13.0 CM	164
DE MARTEL-WOLFSON COLON-ANASTOMOSIS CLAMP FORCEPS, SET W. 3 PCS., 7 CM	249	DESMARRES, RETRACTOR 12.0 MM, 13.0 CM	164
DEAVER RETRACTOR 25 MM 30.5 CM	186	DESMARRES, RETRACTOR 14.0 MM, 13.0 CM	164
DEAVER RETRACTOR 38 MM 30.5 CM	186	DESMARRES, RETRACTOR 16.0 MM, 13.0 CM	164
DEAVER RETRACTOR 50 MM 30.5 CM	186	DESMARRES, RETRACTOR 18.0 MM, 13.0 CM	164
DEAVER RETRACTOR 75 MM 30.5 CM	186	DESMARRES, RETRACTOR 8.0 MM, 13.0 CM	164
DEAVER RETRACTOR WIDTH 19 MM 18.0 CM	184	DIEFFENBACH BULLDOG CLAMPS CVD 3.5 CM	94
DEAVER RETRACTOR WIDTH 22 MM 21.5 CM	184	DIEFFENBACH BULLDOG CLAMPS CVD 5.0 CM	94
DEAVER RETRACTOR WIDTH 25 MM 23.0 CM	184	DIEFFENBACH BULLDOG CLAMPS STR 3.5 CM	94
DEAVER RETRACTOR WIDTH 25 MM 30.0 CM	185	DIEFFENBACH BULLDOG CLAMPS STR 5.0 CM	94
DEAVER RETRACTOR WIDTH 25 MM 33.0 CM	185	DIEFFENBACH OPERATING KNIFE FIG.1	7
DEAVER RETRACTOR WIDTH 25 MM 36.0 CM	185	DIEFFENBACH OPERATING KNIFE FIG.10	7
DEAVER RETRACTOR WIDTH 38 MM 30.0 CM	185	DIEFFENBACH OPERATING KNIFE FIG.2	7
DEAVER RETRACTOR WIDTH 50 MM 30.0 CM	185	DIEFFENBACH OPERATING KNIFE FIG.3	7
DEAVER, SURGICAL SCISSORS CURVED, SHARP/ SHARP, 13,0 CM	16	DIEFFENBACH OPERATING KNIFE FIG.4	7
DEAVER, SURGICAL SCISSORS STRAIGHT, BLUNT/BLUNT, 12,0 CM	15	DIEFFENBACH OPERATING KNIFE FIG.5	7
DEAVER, SURGICAL SCISSORS, CURVED, BLUNT/ BLUNT, 12,0 CM	15	DIEFFENBACH OPERATING KNIFE FIG.6	7
DEAVER, SURGICAL SCISSORS, CURVED, BLUNT/ BLUNT, 14,5 CM	15	DIEFFENBACH OPERATING KNIFE FIG.7	7
DEAVER, SURGICAL SCISSORS, CURVED, SHARP/ BLUNT, 12,0 CM	16	DIEFFENBACH OPERATING KNIFE FIG.8	7
DEAVER, SURGICAL SCISSORS, CURVED, SHARP/ BLUNT, 13,0 CM	16	DIEFFENBACH, OPERATING KNIFE, FIG. 15, 16,0 CM	7
DEAVER, SURGICAL SCISSORS, CURVED, SHARP/ BLUNT, 14, 5 CM	16	DIEFFENBACH, OPERATING KNIFE, FIG. 16, 16,0 CM	7
DEAVER, SURGICAL SCISSORS, CURVED, SHARP/ SHARP, 12,0 CM	16	DIEFFENBACH, OPERATING KNIFE, FIG. 2, 16,0 CM	7
DEAVER, SURGICAL SCISSORS, CURVED, SHARP/ SHARP, 14, 5 CM	16	DIEFFENBACH, OPERATING KNIFE, FIG. 3, 16,0 CM	7
DEAVER, SURGICAL SCISSORS, STRAIGHT, BLUNT/ BLUNT, 13,0 CM	15	DIEFFENBACH, OPERATING KNIFE, FIG. 4, 16,0 CM	7
DEAVER, SURGICAL SCISSORS, STRAIGHT, BLUNT/ BLUNT, 14,5 CM	15	DIEFFENBACH, OPERATING KNIFE, FIG. 5, 16,0 CM	7
DEAVER, SURGICAL SCISSORS, STRAIGHT, SHARP/ BLUNT, 12,0 CM	16	DIEFFENBACH, OPERATING KNIFE, FIG. 7, 16,0 CM	7
DEAVER, SURGICAL SCISSORS, STRAIGHT, SHARP/ BLUNT, 13,0 CM	16	DIEFFENBACH, OPERATING KNIFE, FIG. 9, 16,0 CM	7
DEAVER, SURGICAL SCISSORS, STRAIGHT, SHARP/ BLUNT, 14,5 CM	16	DIEFFENBACH, OPERATION KNIFE, FIG. 6, 16,0 CM	7
DEAVER, SURGICAL SCISSORS, STRAIGHT, SHARP/ SHARP, 12,0 CM	16	DIEFFENBACH, OPERATION KNIFE, FIG. 8, 16,0 CM	7
DEAVER, SURGICAL SCISSORS, STRAIGHT, SHARP/ SHARP, 13,0 CM	16	DIEFFENBACH,OPERATING KNIFE, FIG. 1, 16,0 CM	7
DEAVER, SURGICAL SCISSORS, STRAIGHT, SHARP/ SHARP, 14,5 CM	16	DIEFFENBACH OPERATING KNIFE FIG.9	7
DeBAKEY, SELF-RETAINING RETRACTOR, SHARP, 10,0 CM	195	DIETHRICH MICRO NEEDLE HOLDER TC 26.0CM	133
DeBAKEY, SELF-RETAINING RETRACTOR, SHARP, 17,0 CM	195	DIETHRICH MICRO-NEEDLE HOLDER TC 16.0CM	133
DELICATE HOOK 1 PRONG BLUNT 16.0 CM	161	DIETHRICH MICRO-NEEDLE HOLDER TC 18.0CM	133
DELICATE HOOK 1 PRONG SHARP 16.0 CM	161	DIETHRICH MICRO-NEEDLE HOLDER TC 20.0CM	133
DELICATE HOOK 2 PRONGS BLUNT 16.0 CM	161	DIETHRICH MICRO-NEEDLE HOLDER TC 23.0CM	133
DELICATE HOOK 2-PRONGS SHARP 16.0 CM	161	DIETHRICH, VASCULAR SCS. TC, 125°, 17,5 CM	53
DELICATE HOOK 3 PRONGS BLUNT 16.0 CM	161	DIETHRICH-HEGEMANN, VASCULAR SCS. TC, 25°, 18,0 CM	54
DELICATE HOOK 3 PRONGS SHARP 16.0 CM	161	DIETHRICH-HEGEMANN, VASCULAR SCS. TC, 45°, 18,0 CM	54
DELICATE HOOK 4 PRONGS BLUNT 16.0 CM	161	DIETHRICH-HEGEMANN, VASCULAR SCS. TC, 60°, 18,0 CM	54
DELICATE HOOK 4 PRONGS SHARP 16.0 CM	161	DIETHRICH-HEGEMANN, VASCULAR SCS. TC, 90°, 18,0 CM	54
DELICATE HOOK FIG.1 16.0 CM	159	DIRECTOR (PROBE), GROOVED, WITH BUTTON, 13,0 CM	215
DELICATE HOOK FIG.2 16.0 CM	159	DIRECTOR (PROBE), GROOVED, WITH BUTTON, 14,5 CM	215
DELICATE HOOK FIG.3 16.0 CM	159	DIRECTOR (PROBE), GROOVED, WITH BUTTON, 16,0 CM	215

Inhaltsverzeichnis  
Index

DIRECTOR (PROBE), GROOVED, WITH BUTTON, 18.0 CM	215	DRESSING FORCEPS FINE 16.0CM	64
DISCONTINUED	32	DRESSING FORCEPS FINE 18.0CM	64
DISCONTINUED	200	DRESSING FORCEPS FINE 20.0CM	64
DISPOSABLE SCALPELS, STERILE, FIG. 10, BOX W. 10 PCS.	4	DRESSING FORCEPS FINE 25.0CM	64
DISPOSABLE SCALPELS, STERILE, FIG. 11, BOX W. 10 PCS.	4	DRESSING FORCEPS FINE 30.0CM	64
DISPOSABLE SCALPELS, STERILE, FIG. 11S, BOX W. 10 PCS.	4	DRESSING FORCEPS MOD.USA 13.0 CM	65
DISPOSABLE SCALPELS, STERILE, FIG. 12, BOX W. 10 PCS.	4	DRESSING FORCEPS MOD.USA 14.5 CM	65
DISPOSABLE SCALPELS, STERILE, FIG. 12D, BOX W. 10 PCS.	4	DRESSING FORCEPS MOD.USA 15.5 CM	65
DISPOSABLE SCALPELS, STERILE, FIG. 13, BOX W. 10 PCS.	4	DRESSING FORCEPS MOD.USA 18.0 CM	65
DISPOSABLE SCALPELS, STERILE, FIG. 15, BOX W. 10 PCS.	4	DRESSING FORCEPS MOD.USA 21.0 CM	65
DISPOSABLE SCALPELS, STERILE, FIG. 15C, BOX W. 10 PCS.	4	DRESSING FORCEPS MOD.USA 25.0 CM	65
DISPOSABLE SCALPELS, STERILE, FIG. 18, BOX W. 10 PCS.	5	DRESSING FORCEPS MOD.USA 31.0 CM	65
DISPOSABLE SCALPELS, STERILE, FIG. 19, BOX W. 10 PCS.	5	DRESSING FORCEPS NARROW 10.5 CM	64
DISPOSABLE SCALPELS, STERILE, FIG. 20, BOX W. 10 PCS.	5	DRESSING FORCEPS NARROW 11,5 CM	64
DISPOSABLE SCALPELS, STERILE, FIG. 21, BOX W. 10 PCS.	5	DRESSING FORCEPS NARROW 13,0 CM	64
DISPOSABLE SCALPELS, STERILE, FIG. 22, BOX W. 10 PCS.	5	DRESSING FORCEPS NARROW 14,5 CM	64
DISPOSABLE SCALPELS, STERILE, FIG. 23, BOX W. 10 PCS.	5	DRESSING FORCEPS NARROW 16,0 CM	64
DISPOSABLE SCALPELS, STERILE, FIG. 24, BOX W. 10 PCS.	5	DRESSING FORCEPS NARROW 18,0 CM	64
DISPOSABLE SCALPELS, STERILE, FIG. 25, BOX W. 10 PCS.	5	DRESSING FORCEPS NARROW 20,0 CM	64
DISSECTION MICRO SCISSORS BL/BL 14.5 CM CURVED	60	DRESSING FORCEPS NARROW 25,0 CM	64
DISSECTION MICRO SCISSORS BL/BL 15.0 CM	60	DRESSING FORCEPS NARROW 30,0 CM	64
DISSECTION MICRO SCISSORS BL/BL 18.0 CM	60	DRESSING FORCEPS NARROW CVD 10.5 CM	64
DISSECTION MICRO SCISSORS BL/BL, SERRATED, 15.0 CM	60	DRESSING FORCEPS NARROW CVD 11.5 CM	64
DIXON-LOVELACE ART.FORCEPS STR 15.5 CM	103	DRESSING FORCEPS NARROW CVD 13.0 CM	64
DIXON-LOVELACE STR.1X2 T 15.5 CM	103	DRESSING FORCEPS NARROW CVD 14.5 CM	64
DOUGALS TROCAR 11.0 CM 3.0 MM	221	DRESSING FORCEPS NARROW CVD 16.0 CM	64
DOYEN ABD.SCISSORS CVD BL/BL 16.0 CM	40	DRESSING FORCEPS NARROW CVD 18.0 CM	64
DOYEN ABD.SCISSORS STR BL/BL 16.0 CM	40	DRESSING FORCEPS NARROW CVD 20.0 CM	64
DOYEN ABD.SCISSORS STR SH/BL 16.0 CM	40	DRESSING FORCEPS NARROW CVD 25.0 CM	64
DOYEN ABDOMINAL SCISSORS CURVED 17,5 CM	40	DRESSING FORCEPS NARROW CVD 30.0 CM	64
DOYEN ABDOMINAL SCISSORS STRAIGHT 17.5CM	40	DRESSING FORCEPS, ENGL. PATTERN, 13.0 CM	67
DOYEN AT INTEST.CLAMP FCPS. CVD. 21.0 CM	246	DRESSING FORCEPS, ENGL. PATTERN, 14.5 CM	67
DOYEN AT INTEST.CLAMP FCPS. CVD. 23.0 CM	246	DRESSING FORCEPS, ENGL. PATTERN, 15.0 CM	67
DOYEN AT INTEST.CLAMP FCPS. STR. 23.0 CM	246	DRESSING FORCEPS, FINE, CURVED, 10,5CM	65
DOYEN AT INTEST.CLAMP FCPS. STR.21,0 CM	246	DRESSING FORCEPS, FINE, CURVED, 11,5CM	65
DOYEN INTESTINAL CLAMP FCPS CVD 21.0 CM	245	DRESSING FORCEPS, FINE, CURVED, 13,0CM	65
DOYEN INTESTINAL CLAMP FCPS CVD 23.0 CM	245	DRESSING FORCEPS, FINE, CURVED, 14,5CM	65
DOYEN INTESTINAL CLAMP FCPS STR 21.0 CM	245	DRESSING FORCEPS, FINE, CURVED, 16.0CM	65
DOYEN INTESTINAL CLAMP FCPS STR 23.0 CM	245	DRESSING FORCEPS, FINE, CURVED, 18.0CM	65
DOYEN MYOMA SCREW 17.0 CM	279	DRESSING FORCEPS, FINE, CURVED, 20.0CM	65
DOYEN MYOMA SCREW 17.0CM	279	DRESSING FORCEPS, FINE, CURVED, 25.0CM	65
DOYEN PERIOST.RASPATORY CVD LEFT 17.0 CM	303	DRESSING FORCEPS, FINE, CURVED, 30.0CM	65
DOYEN PERIOST.RASPATORY CVD LEFT 17.0CM	303	DUBOIS CEPHALOTOMY SCS CVD BL/BL 27.0 CM	41
DOYEN PERISOT.RASPATORY CVD RIGHT 17.0CM	303	DUBOIS CEPHALOTOMY SCS STR BL/BL 27.0 CM	41
DOYEN PROBE 14.5 CM	214	DUEHRSEN, DRESSING FCPS., 20.0 CM	68
DOYEN RETRACTOR 50X85 MM 25.0 CM	178	DUEHRSEN TISSUE FCPS 1X2 TEETH 20.0 CM	75
DOYEN RETRACTOR 55X105 MM 28.0 CM	209	DUEHRSEN TISSUE FCPS 2X3 TEETH 20.0 CM	75
DOYEN RETRACTOR 55X105 MM 28.0 CM	209	DUEHRSEN TISSUE FCPS 3X4 TEETH 20.0 CM	75
DOYEN RETRACTOR 55X125 MM 28.0 CM	209	DUPLAY, UTERINE TENACULUM FORCEPS, 28.0 CM	273
DOYEN RETRACTOR 55X95 MM 28.0 CM	209	DURANTE TISSUE FCPS 16.0 CM	75
DOYEN VAG.SPECULUM SL.CONCAVE 115X35 MM	264	DURANTE TISSUE FORCEPS 14.5 CM	75
DOYEN VAG.SPECULUM SL.CONCAVE 115X45 MM	264	DURANTE TISSUE FORCEPS 20,0 CM	75
DOYEN VAG.SPECULUM SL.CONCAVE 115X60 MM	264	DUVAL INT.TISSUE FCPS LARGE 20.0 CM	245
DOYEN VAG.SPECULUM SL.CONCAVE 160X45 MM	264	DUVAL INT.TISSUE FCPS LARGE 23.0 CM	245
DOYEN VAG.SPECULUM SL.CONCAVE 160X60 MM	264	DUVAL INT.TISSUE FCPS SMALL 20.0 CM	245
DOYEN VAG.SPECULUM SL.CONCAVE 55X35 MM	264	DUVAL INT.TISSUE FCPS TC 20.0 CM	244
DOYEN VAG.SPECULUM SL.CONCAVE 55X45 MM	264	DUVAL INT.TISSUE FORCEPS SMALL 18,0 CM	245
DOYEN VAG.SPECULUM SL.CONCAVE 55X60 MM	264	DUVAL, INTESTINAL FORCEPS, FIG.1, 14.0 CM	75
DOYEN VAG.SPECULUM SL.CONCAVE 85X35 MM	264	DUVAL, INTESTINAL FORCEPS, FIG.2, 14.0 CM	75
DOYEN VAG.SPECULUM SL.CONCAVE 85X45 MM	264	EISELSBERG LIGATURE SCISSORS 11.0 CM	34
DOYEN VAG.SPECULUM SL.CONCAVE 85X60 MM	264	ELLIOT, OBSTETREICAL FORCEPS, 32.0 CM	290
DOYEN, POLYPUS AND OVUM FORCEPS, 20,5 CM	276	ELLIOT, OBSTETREICAL FORCEPS, 38,0 CM	290
DOYEN, VAGINAL SPECULA, 60X30 MM	268	EMMET FISTULA HOOK FIG.1 22.0 CM	279
DOYEN, VAGINAL SPECULA, 80X30 MM	268	EMMET FISTULA HOOK FIG.2 22.0 CM	279
DOYEN, VAGINAL SPECULA, MEDIUM CONCAVE, 115X35 MM	264	EMMET FISTULA HOOK FIG.3 22.0 CM	279
DOYEN, VAGINAL SPECULA, MEDIUM CONCAVE, 115X45 MM	264	EMMET FISTULA HOOK FIG.4 22.0 CM	279
DOYEN, VAGINAL SPECULA, MEDIUM CONCAVE, 115X60 MM	264	EMMET FISTULA HOOK FIG.5 22.0 CM	279
DOYEN, VAGINAL SPECULA, MEDIUM CONCAVE, 55X35 MM	264	ENDARTERECTOMY, DISSEC.-SCS., SUPERCUT, CURVED, BL/BL, 18.0 CM	56
DOYEN, VAGINAL SPECULA, MEDIUM CONCAVE, 55X45 MM	264	ENGL.MODEL TOWEL FORCEPS 9,0 CM	86
DOYEN, VAGINAL SPECULA, MEDIUM CONCAVE, 55X60 MM	264	ENTEROTOMY SCS FOR ANATOMY 21.0 CM	41
DOYEN, VAGINAL SPECULA, MEDIUM CONCAVE, 85X35 MM	264	ENTEROTOMY SCS. FOR ANATOMY 21.0 CM	41
DOYEN, VAGINAL SPECULA, MEDIUM CONCAVE, 85X45 MM	264	ENTEROTOMY SCS. FOR ANATOMY 21.0 CM	41
DOYEN, VAGINAL SPECULA, MEDIUM CONCAVE, 85X60 MM	264	EPISIOTOMY-SCISSORS 20,0 CM	43
DOYEN-STILLE, RETRACTOR, 105x30 MM, 22,0 CM	179	EPPENDORF CERV.BIOPSY+SPEC.FCPS 20,0 CM	287
DOYEN-STILLE, RETRACTOR, 120x52 MM, 22,0 CM	179	ESMARCH BANDAGE SCISSORS 20.0 CM	45
DOYEN-STILLE, RETRACTOR,90x28 MM, 22,0 CM	179	ESMARCH BANDAGE SCISSORS 22.0 CM	45
DRESSING FCPS MOD.USA GRACILE 13.0 CM	65	EXCHANGEABLE BLADE 100X70 MM	203
DRESSING FCPS MOD.USA GRACILE 14.5 CM	65	EXCHANGEABLE BLADE 38X62 MM	200
DRESSING FCPS MOD.USA GRACILE 15.5 CM	65	EXCHANGEABLE BLADE 38X80 MM	200
DRESSING FCPS MOD.USA GRACILE 18.0 CM	65	EXCHANGEABLE BLADE 50X58 MM	200
DRESSING FCPS MOD.USA GRACILE 20.0 CM	65	EXCHANGEABLE BLADE 60X80 MM	200
DRESSING FCPS MOD.USA GRACILE 25.0 CM	65	EXCHANGEABLE BLADE 60X80 MM	200
DRESSING FCPS., STANDARD, TC, 14,5 CM	82	EXCHANGEABLE BLADE 62X80 MM	200
DRESSING FCPS., STANDARD, TC, 18,0 CM	82	EXCHANGEABLE BLADE 62X80 MM	200
DRESSING FCPS., STANDARD, TC, 20,0 CM	82	EXCHANGEABLE BLADE 72X85 MM	200
DRESSING FCPS., STANDARD, TC, 25,0 CM	82	FALK LIGATURE NEEDLE LEFT 24.0 CM	150
DRESSING FORCEPS FINE 10,5CM	64	FALK LIGATURE NEEDLE RIGHT 24.0 CM	150
DRESSING FORCEPS FINE 11,5CM	64	FANSLER, ANOSCOPE, Ø 25 X 65 MM	254
DRESSING FORCEPS FINE 13,0CM	64	FANSLER, ANOSCOPE, Ø 29 X 65 MM	254
DRESSING FORCEPS FINE 14,5CM	64	FANSLER, ANOSCOPE, Ø 38 X 70 MM	254

FARABEUF PERIOSTEAL RASPARTORY CVD 15.0CM	303	FRANZ, ABDOMINAL RETRACTOR, VALVE ONLY, 45X80 MM	208
FARABEUF PERIOSTEAL RASPARTORY STR 15.0CM	302	FRANZ, ABDOMINAL RETRACTOR, VALVE ONLY, 50X65 MM	208
FARABEUF RETRACTOR SET FIG.1+2 12.0 CM	167	FRANZ, ABDOMINAL RETRACTOR, VALVE ONLY, 60X85 MM	208
FARABEUF, RETRACTOR SET FIG.1+2, 15.0 CM	167	FRAZIER BRAIN SUCTION TUBE CHARR 6/17CM	223
FARREL COTTON APPL.0.9 MM 12.0 CM ROUND	216	FRAZIER BRAIN SUCTION TUBE CHARR10/17CM	223
FARREL COTTON APPL.0.9 MM 14.0 CM ROUND	216	FRAZIER SUCTION TUBE CHARR 12/ 17.0CM	223
FARREL COTTON APPL.1.1 MM 16.5 CM ROUND	216	FRAZIER SUCTION TUBE CHARR 8/17CM	223
FARREL COTTON APPL.1.2 MM 18.0 CM ROUND	216	FRAZIER, DURA AND SKIN RETRACTOR, SHARP, 13.0 CM	158
FARREL COTTON APPL.TRIANGLE SERR.0.9 MM	216	FRITSCH RETRACTOR 45X40 MM 24.0 CM	178
FARREL COTTON APPL.TRIANGLE SERR.0.9 MM	216	FRITSCH RETRACTOR 45X50 MM 24.0 CM	178
FARREL COTTON APPL.TRIANGLE SERR.1.2 MM	216	FRITSCH RETRACTOR 45X60 MM 24.0 CM	178
FARREL COTTON APPL.TRIANGLE SERR.1.1 MM	216	FRITSCH RETRACTOR 45X75 MM 24.0 CM	178
FAURE PERIT.CLAMP-FCPS 1X2 T. 20.0 CM	119	FRITSCH RETRACTOR 65X85 MM 24.0 CM	178
FAURE PERIT.CLAMP-FCPS 1X2 T. 20.0 CM	119	GARLAND CLAMP FORCEPS 21.0 CM	121
FAURE, CERVICAL BIOPSY+SPEC FCPS 23.0 CM	287	GELPI RETRACTOR 14.0 CM	193
FAVALORO ARTERY SCISSORS 15.0 CM	38	GELPI RETRACTOR 19.0 CM	193
FEILCHENFELD SPLINTER FORCEPS 11,5 CM	78	GELPI-LOKTITE, RETRACTOR, 18.0 CM	193
FEILCHENFELD SPLINTER FORCEPS 7,5 CM	78	GEMINI, DISSECTING AND LIGATURE FCPS, CURVED, 14,0 CM	112
FEILCHENFELD SPLINTER FORCEPS 9,0 CM	78	GEMINI, DISSECTING AND LIGATURE FCPS, CURVED, 16,0 CM	112
FEIN COTTON APPLICATOR 28.0 CM	216	GEMINI, DISSECTING AND LIGATURE FCPS, CURVED, 18,0 CM	112
FERGUSSON OPERATING SCISSORS 16.5 CM	32	GEMINI, DISSECTING AND LIGATURE FCPS, CURVED, 20,0 CM	112
FERGUSSON OPERATING SCISSORS 18.0 CM	32	GEMINI, DISSECTING AND LIGATURE FCPS, CURVED, 23,0 CM	112
FERGUSSON ANGIOTRIBE CVD.16.0 CM	98	GEMINI, DISSECTING AND LIGATURE FCPS, CURVED, 25,0 CM	112
FERGUSSON ANGIOTRIBE CVD.20.0 CM	98	GEMINI, DISSECTING AND LIGATURE FCPS, CURVED, 28,0 CM	112
FERGUSSON ANGIOTRIBE STR.16.0 CM	98	GERALD DRESSING FORCEPS CVD 18.0 CM	67
FERGUSSON ANGIOTRIBE STR.20.0 CM	98	GERALD TISSUE FORCEPS CVD 1X2 T. 17.0 CM	73
FERGUSSON, GALL STONE SCOOPS, DOUBLE-ENDED, 21,5 CM	234	GERALD TISSUE FORCEPS STR 1X2 T 17.0 CM	73
FERGUSSON, SUCTION TUBE Ø 2.0 MM, CHARR. 6, 18.0 CM LUER ATTACHMENT	223	GERALD, DRESSING FCPS, TC, 17.0 CM	83
FERGUSSON, SUCTION TUBE Ø 2.6MM, CHARR. 8, 18.0 CM LUER ATTACHMENT	223	GERALD, DRESSING FORCEPS STRAIGHT, 18.0 CM	66
FERGUSSON, SUCTION TUBE Ø 3.3MM, CHARR. 10, 18.0 CM LUER ATTACHMENT	223	GERALD, TISSUE FORCEPS, 1X2 TEETH, TC, 17.0 CM	83
FERGUSSON, SUCTION TUBE Ø 4.0MM, CHARR. 12, 18.0 CM LUER ATTACHMENT	223	GILLIES NEEDLE HOLDER/SCS TC 16.0 CM	140
FIBRE OPTIC LIGHT CARRIER FOR ALAN PARKS	253	GILLIES TISSUE FCPS 1X2 TEETH 15.0 CM	72
FINE OPER.SCISSORS CVD SH/SH 11.0 CM ROUNDED SHANKS	29	GILLIES TISSUE FORCEPS 1X2 T.TC 15.0 CM	83
FINE OPER.SCISSORS STR SH/SH 11.0 CM ROUNDED SHANKS	29	GILLIES, DURA AND SKIN HOOK, FIG. 1 SHARP, 18,5 CM	158
FINE OPER.SCISSORS STR SH/SH 11.5 CM ROUNDED SHANKS	29	GILLIES, DURA AND SKIN HOOK, FIG. 2 SHARP, 18,5 CM	158
FINE OPERATING SCISSORS CURVED, SHARP/SHARP, 11.5 CM ROUND SHANKS	29	GIL-VERNET RETRACTOR 11 MM 24.0 CM	166
FINE OPERATING SCISSORS STRAIGHT, SHARP/SHARP, 12,0 CM	30	GIL-VERNET RETRACTOR 11 MM 24.5 CM	166
FINE OPERATING SCISSORS, CURVED, SHARP/SHARP, 12,0 CM	30	GIL-VERNET RETRACTOR 13 MM 24.0 CM	166
FINGER NAIL DRILL, DRILL ONLY	294	GIL-VERNET RETRACTOR 13 MM 24.5 CM	166
FINGER NAIL DRILL, DRILL ONLY	294	GIL-VERNET RETRACTOR 18 MM 24.0 CM	166
FINGER NAIL DRILL, DRILL ONLY	294	GIL-VERNET RETRACTOR 18 MM 24.5 CM	166
FINGER NAIL DRILL, WITH 4 DRILL POINTS	294	GIL-VERNET RETRACTOR 9 MM 24.0 CM	166
FINGER RING SAW MOD.MARTIN	296	GIL-VERNET RETRACTOR 9 MM 24.5 CM	166
FINGER RING SAW, BOX-LOCK	296	GIL-VERNET, RETRACTOR, 20 MM, 24,5 CM	166
FINOCCHIETTO ARTERY FORCEPS 24.0 CM	115	GIL-VERNET, RETRACTOR, 20 MM, 24,0 CM	166
FINOCCHIETTO NEEDLE HOLDER ANGLED 27.0CM	127	GIL-VERNET, RETRACTOR, 23 MM, 24,5 CM	166
FINOCCHIETTO NEEDLE HOLDER TC 27.0 CM	138	GIL-VERNET, RETRACTOR, 23 MM, 24,0 CM	166
FINOCCHIETTO RIB SPREADER 40X40X165	211	GLASSMAN, INTESTINAL CLAMP FORCEPS, 60° ANGLED, 23,0 CM	248
FINOCCHIETTO RIB SPREADER 45X65X200	211	GLASSMAN, INTESTINAL CLAMP FORCEPS, 90° ANGLED, 23,5 CM	248
FINOCCHIETTO RIB SPREADER 70X65X250	211	GLOVER ATRAUMA-BULLDOG CLAMP CURVED, 5,5 CM	96
FINOCCHIETTO-BABY RIB SPREADER 18X20/75	211	GLOVER ATRAUMA-BULLDOG CLAMP STR 6.0 CM	96
FINOCCHIETTO LOBECT SCS CVD BL 27.0 CM	42	GLOVER ATRAUMA-BULLDOG CLAMP STRAIGHT 9.0CM	96
FINSEN RETRACTOR BL 2X3 PRONGS 5.0 CM	188	GLOVER ATRAUMA-BULLDOG CLAMP CVD 10.5CM	96
FINSEN RETRACTOR BL 3X4 PRONGS 7.0 CM	188	GLOVER ATRAUMA-BULLDOG CLAMP CVD 8.5 CM	96
FINSEN RETRACTOR SH 2X3 PRONGS 5.0 CM	188	GLOVER ATRAUMA-BULLDOG CLAMP STR 11.0CM	96
FINSEN RETRACTOR SH 3X4 PRONGS 7.0 CM	188	GOELET RETRACTOR 19.0 CM	169
FISTULA HOOK, 25,0 CM	279	GOMEL, MICRO-NEEDLE HOLDER, CURVED, 14,0 CM	130
FOERSTER SPONGE HOLDING NARROW CVD 25.0C	90	GOMEL, MICRO-SCS., ROUND-HANDLE, 1 BLADE SERRATED, CURVED, 14,0 CM	59
FOERSTER SPONGE HOLDING NARROW STR 25.0C	90	GOMEL, MICRO-SCS., ROUND-HANDLE, 1 BLADE SERRATED, CURVED, 16,0 CM	59
FOERSTER-BALLENGER CVD SERRATED 18.0 CM	90	GOOD TONSIL SCISSORS CVD 19.0 CM	36
FOERSTER-BALLENGER CVD SERRATED 25.0 CM	90	GOSSET ABDOMINAL RETRACTOR 100MM OPENING	201
FOERSTER-BALLENGER CVD SMOOTH 18.0 CM	90	GOSSET ABDOMINAL RETRACTOR 140MM OPENING	201
FOERSTER-BALLENGER CVD SMOOTH 25.0 CM	90	GOSSET ABDOMINAL RETRACTOR 160MM OPENING	201
FOERSTER-BALLENGER FCPS CURVED 20,0 CM	90	GOUGE, 10MM 13,5CM	304
FOERSTER-BALLENGER FCPS CVD.SERR.20,0 CM	90	GOUGE, 12MM 13,5CM	304
FOERSTER-BALLENGER FCPS STRAIGHT 20,0 CM	90	GOUGE, 14MM 13,5CM	304
FOERSTER-BALLENGER FCPS STR.SERR.20,0 CM	90	GOUGE, 16MM 13,5CM	304
FOERSTER-BALLENGER STR SERRATED 18.0 CM	90	GOUGE, 8MM 13,5CM	304
FOERSTER-BALLENGER STR SERRATED 25.0 CM	90	GRAEFE DELICATE HOOK BLUNT 16,0 CM	158
FOERSTER-BALLENGER STR SMOOTH 18.0 CM	90	GRAEFE DELICATE HOOK SHARP 16,0 CM	158
FOERSTER-BALLENGER STR SMOOTH 25.0 CM	90	GRAEFE IRIS FCPS STRO.CVD 1X2 T. 10.0 CM	79
FOMON NASAL SCISSORS BLUNT 13,5 CM	33	GRAEFE IRIS FORCEPS SL.CVD 1X2 T. 10.0CM	79
FOMON, DISSECTING SCISSORS CURVED, 13,5 CM	19	GRAEFE IRIS FORCEPS SL.CVD SERR. 10.0 CM	79
FOMON, NASAL SCS., SUPERCUT, BL/BL, 14,5 CM	58	GRAEFE IRIS FORCEPS STR 1X2 TEETH 10.0CM	79
FORCEPS FINE PATTERN STR 10.5 CM	65	GRAEFE IRIS FORCEPS STR SERR. 10.0 CM	79
FORCEPS FINE PATTERN STR 11.5 CM	65	GRAEFE IRIS FORCEPS STRO.CVD SERR 10.0CM	79
FORCEPS FINE PATTERN STR 13.0 CM	65	GRAVE VAG.SPECULUM 115 X 35 MM	260
FORCEPS FINE PATTERN STR 14.5 CM	65	GRAVE VAG.SPECULUM 75 X 20 MM	260
FORCEPS FINE PATTERN STR 16.0 CM	65	GRAVE VAG.SPECULUM 95 X 35 MM	260
FORCEPS FINE PATTERN STR 18.0 CM	65	GRAY GALL DUCT CLAMP, S' 1X2 T 22.0 CM	115
FORCEPS FINE PATTERN STR 20.0 CM	65	GRAY GALL DUCT CLAMP, S' 1X2 T. 23.0 CM	115
FORCEPS FINE PATTERN STR 25.0 CM	65	GRAY GALL DUCT CLAMP S-SHAPED 22.0 CM	115
FORCEPS FINE PATTERN STR 30.0 CM	65	GRAY GALL DUCT CLAMP S-SHAPED 23.0 CM	115
FOX, LUPUS CURETTE, Ø 3 MM, 14,0 CM	295	GREEN-ARMYTAGE, CAESAREAN SECTION HAEMOSTATIC FORCEPS, 21,0 CM	291
FOX, LUPUS CURETTE, Ø 4 MM, 14,0 CM	295	GROOVED DIRECTOR 11.5 CM	215
FOX, LUPUS CURETTE, Ø 5 MM, 14,0 CM	295	GROOVED DIRECTOR 13.0 CM	215
FOX, LUPUS CURETTE, Ø 6 MM, 14,0 CM	295	GROOVED DIRECTOR 14.5 CM	215
FRANZ, ABDOMINAL RETRACTOR, COMPLETE	208	GROOVED DIRECTOR 16.0 CM	215
FRANZ, ABDOMINAL RETRACTOR, FRAME ONLY, 300X300 MM	208	GROOVED DIRECTOR 18.0 CM	215
FRANZ, ABDOMINAL RETRACTOR, VALVE ONLY, 38X60 MM	208	GROOVED DIRECTOR 20.0 CM	215

Inhaltsverzeichnis  
Index

GROOVED DIRECTOR WITH PROBE 11.0 CM	215	HEGAR UT.DILATOR W.SLOPED HDL.15.0 MM	270
GROSS-MAIER DRESSING FCPS CURVED 20,0 CM	90	HEGAR UT.DILATOR W.SLOPED HDL.15.5 MM	270
GROSS-MAIER DRESSING FCPS CURVED 22,0 CM	90	HEGAR UT.DILATOR W.SLOPED HDL.16.0 MM	270
GROSS-MAIER DRESSING FCPS CURVED 25,0 CM	90	HEGAR UT.DILATOR W.SLOPED HDL.16.5 MM	270
GROSS-MAIER DRESSING FCPS CURVED 27,0 CM	90	HEGAR UT.DILATOR W.SLOPED HDL.17.0 MM	270
GROSS-MAIER DRESSING FCPS STR 20,0 CM	90	HEGAR UT.DILATOR W.SLOPED HDL.17.5 MM	270
GROSS-MAIER DRESSING FCPS STR 22,0 CM	90	HEGAR UT.DILATOR W.SLOPED HDL.18.0 MM	270
GROSS-MAIER DRESSING FCPS STR 25,0 CM	90	HEGAR UT.DILATOR W.SLOPED HDL.19.0 MM	270
GROSS-MAIER DRESSING FCPS STR 27,0 CM	90	HEGAR UT.DILATOR W.SLOPED HDL.2.5 MM	270
GUTHRIE DELICATE HOOK FIG.1 16.0 CM	159	HEGAR UT.DILATOR W.SLOPED HDL.20 MM	270
GUTHRIE DELICATE HOOK FIG.2 16.0 CM	159	HEGAR UT.DILATOR W.SLOPED HDL.21 MM	270
GUYON KIDNEY PED.CLAMP FCPS.23.0 CM	116	HEGAR UT.DILATOR W.SLOPED HDL.22 MM	270
GUYON KIDNEY PEDICLE CLAMP FCPS 20.0 CM	116	HEGAR UT.DILATOR W.SLOPED HDL.23 MM	270
GUYON KIDNEY PEDICLE CLAMP FCPS 22.0 CM	116	HEGAR UT.DILATOR W.SLOPED HDL.24 MM	270
GUYON KIDNEY PEDICLE CLAMP FCPS 24.0 CM	116	HEGAR UT.DILATOR W.SLOPED HDL.25 MM	270
GUYON, ATRAUMATIC GALL DUCT AND KIDNEY PEDICLE CLAMPS, 23,0 CM	116	HEGAR UT.DILATOR W.SLOPED HDL.26 MM	270
GUYON, ATRAUMATIC GALL DUCT AND KIDNEY PEDICLE CLAMPS, 24,0 CM	116	HEGAR UT.DILATOR W.SLOPED HDL.3.5 MM	270
HABERER, ABDOMINAL SPATULA, 280 x 25/30 MM, MALLEABLE	210	HEGAR UT.DILATOR W.SLOPED HDL.4.5 MM	270
HABERER, ABDOMINAL SPATULA, 280 x 40/50 MM, MALLEABLE	210	HEGAR UT.DILATOR W.SLOPED HDL.5.5 MM	270
HABERER, ABDOMINAL SPATULA, 300 x 37/45 MM, MALLEABLE	210	HEGAR UT.DILATOR W.SLOPED HDL.6.5 MM	270
HALLE NASAL SCISSORS CURVED 19.0 CM	33	HEGAR UT.DILATOR W.SLOPED HDL.7.5 MM	270
HALLE, BONE CURETTE MALLEABLE, FIG. 00, 21.0 CM	299	HEGAR UT.DILATOR W.SLOPED HDL.8.5 MM	270
HALLE, BONE CURETTE, MALLEABLE, FIG. 0, 21.0 CM	299	HEGAR UT.DILATOR W.SLOPED HDL.9.5 MM	270
HALLE, BONE CURETTE, MALLEABLE, FIG. 1, 21.0 CM	299	HEGAR UTERINE DILATORS 1.0/2.0MM	271
HALSEY NEEDLE HOLDER 13.0 CM	124	HEGAR UTERINE DILATORS 11.0/12.0MM	271
HALSEY NEEDLE HOLDER SMOOTH JAWS 13.0 CM	124	HEGAR UTERINE DILATORS 13.0/14.0MM	271
HALSEY NEEDLE HOLDER TC 13.0 CM	134	HEGAR UTERINE DILATORS 15.0/16.0MM	271
HALSEY NEEDLE HOLDER TC SMOOTH 13.0CM	134	HEGAR UTERINE DILATORS 17.0/18.0MM	271
HALSTED ARTERY FCPS.CVD 18.0 CM	100	HEGAR UTERINE DILATORS 19.0/20.0MM	271
HALSTED ARTERY FCPS.CVD 1X2 18.0 CM	100	HEGAR UTERINE DILATORS 21.0/22.0MM	271
HALSTED ARTERY FCPS.CVD 1X2 21.0 CM	100	HEGAR UTERINE DILATORS 23.0/24.0MM	271
HALSTED ARTERY FCPS.CVD 21.0 CM	100	HEGAR UTERINE DILATORS 25.0/26.0MM	271
HALSTED ARTERY FCPS.STR 18.0 CM	100	HEGAR UTERINE DILATORS 3.0/4.0MM	271
HALSTED ARTERY FCPS.STR 1X2 18.0 CM	100	HEGAR UTERINE DILATORS 5.0/6.0MM	271
HALSTED ARTERY FCPS.STR 1X2 21.0 CM	100	HEGAR UTERINE DILATORS 7.0/8.0MM	271
HALSTED ARTERY FCPS.STR 21.0 CM	100	HEGAR UTERINE DILATORS 9.0/10.0MM	271
HALSTED-MOSQUITO ART.FCPS CVD 14,0 CM	100	HEGAR, NEEDLE HOLDER WITH TC, 20,0 CM	139
HALSTED-MOSQUITO ART.FCPS STR 14,0 CM	100	HEGAR, NEEDLE HOLDER WITH TC, 24,0 CM	139
HALSTED-MOSQUITO ART.FCPS.1X2 CVD 14.0CM	100	HEGAR, UTERINE-DILATOR, SET OF 13 PCS., Ø1,0/2,0 - 25,0/26,0 MM	271
HALSTED-MOSQUITO ART.FCPS.1X2 STR 12.5CM	100	HEGAR, UTERINE-DILATOR, SET OF 8 PCS., Ø 3/4-17/18MM	271
HALSTED-MOSQUITO FCPS.1X2 CVD 12.5CM	100	HEGAR-BAUMGARTNER, NEEDLE HOLDER, WITH TC,12,5 CM	133
HALSTED-MOSQUITO FCPS.1X2 STR 14.0CM	100	HEGAR-BAUMGARTNER, NEEDLE HOLDER, WITH TC,14,0 CM	133
HALSTED-MOSQUITO, ARTERY FORCEPS CURVED, 12,5 CM	100	HEGAR-BAUMGARTNER, NEEDLE HOLDER,14,0CM	124
HALSTED-MOSQUITO, ARTERY FORCEPS STRAIGHT, 12,5 CM	100	HEGAR-VASCULAR, NEEDLE HOLDER WITH TC, 14,0 CM	138
HANDBRUSH, STERILIZABLE	311	HEGAR-VASCULAR, NEEDLE HOLDER WITH TC, 18,0 CM	138
HANK SET OF 6 DILATORS 4.5/5-9.5/10MM	271	HEGAR-VASCULAR, NEEDLE HOLDER WITH TC, 20,0 CM	138
HANK UTERINE DILATOR FIG.19/20,9.5/10MM	271	HEGAR-VASCULAR, NEEDLE HOLDER WITH TC, 23,0 CM	138
HANK UTERINE DILATORS FIG.11/12,5.5/6MM	271	HEGEMANN-DIETHRICH VASC.SCS 125DEG19.0CM	38
HANK UTERINE DILATORS FIG.13/14,6.5/7MM	271	HEGEMANN-DIETHRICH, VASCULAR SCISSORS, 125°, 19,0 CM	37
HANK UTERINE DILATORS FIG.15/16,7.5/8MM	271	HEGEMANN-DIETHRICH, VASCULAR SCISSORS, 25°, 19,0 CM	37
HANK UTERINE DILATORS FIG.17/18,8.5/9MM	271	HEGEMANN-DIETHRICH, VASCULAR SCISSORS, 45°, 19,0 CM	37
HANK UTERINE DILATORS FIG.9/10,4.5/5MM	271	HEGEMANN-DIETHRICH, VASCULAR SCISSORS, 60°, 19,0 CM	37
HARRINGTON RETRACTOR 127X40 MM 32.0 CM	182	HEGEMANN-DIETHRICH, VASCULAR SCISSORS, 90°, 19,0 CM	37
HARRINGTON RETRACTOR 127X62 MM 32.0 CM	182	HEGENBARTH SUTURE FORCEPS 12.5 CM	154
HARTMANN FORCEPS STR 10.0 CM	99	HEISS ARTERY FORCEPS STR. 20.0 CM FIG.1	107
HARTMANN, ARTERY FORCEPS CURVED, 10.0 CM	99	HEISS ARTERY FORCEPS STRONG CURVE 20,0CM	107
HAYES, SIGMOID ANASTOMOSIS FORCEPS, 26,0 CM	251	HEISS FORCEPS SLIGHTLY CVD 20.0CM	107
HAYES, SIGMOID ANASTOMOSIS FORCEPS, 28,0 CM	251	HENLEY EXCHANGEABLE BLADE 16X19 MM	197
HEANEY CLAMP-FORCEPS 1 TOOTH 21.0 CM	122	HENLEY EXCHANGEABLE BLADE 16X25 MM	197
HEANEY CLAMP-FORCEPS 1 TOOTH 23.0 CM	122	HENLEY EXCHANGEABLE BLADES 16X32 MM	197
HEANEY CLAMP-FORCEPS 2 TEETH 21.5 CM	122	HENLEY, SELF-RETAINING RETRACTOR, ONLY BLUNT, 3 X 4 TEETH, 16,0 CM	197
HEANEY CLAMP-FORCEPS 2 TEETH 23.0 CM	122	HENLEY, SELF-RETAINING RETRACTOR, ONLY SHARP, 3 X 4 TEETH, 16,0 CM	197
HEANEY CLAMP-FORCEPS LIGHT JAWS 21.0 CM	121	HEPP SCHEIDEL, MICRO-NEEDLE HOLDER WITH TC, 18,0 CM	144
HEANEY NEEDLE HOLDER CVD 21.0 CM	127	HEPP/SCHIEDEL, SUCTION TUBE, W. IRRIGATION, 22,5 CM	223
HEANEY-BALLANTINE CLAMP FCPS.CVD 21.0 CM	121	HEPP-SCHIEDEL, MICRO-SCS., ROUND-HANDLE, CURVED, 14,0 CM	59
HEANEY-BALLANTINE CLAMP FCPS.STR 21.0 CM	121	HEPP-SCHIEDEL, MICRO-SCS., ROUND-HANDLE, CURVED, 16,0 CM	59
HEANEY-KANTER CLAMP FCPS. 2 TEETH21.0 CM	121	HERRICK KIDNEY PEDICLE CLAMP FCPS 23.0CM	117
HEATH LIGATURE SCISSORS 15.0 CM	34	HESS BULLDOG CLAMPS, 2,0 cm	94
HEGAR DILATORS, SET, Ø 1-26 MM, W. METAL CASE	270	HESS, BULLDOG CLAMPS, 3,0 cm	94
HEGAR DILATORS, SET, Ø 4-17 MM, W. METAL CASE	270	HESSBERG LIGATURE NEEDLE 15.0 CM	149
HEGAR UT DILATOR W.SLOPED HDL 7.0 MM	270	HEYMANN NASAL SCISSORS BLUNT 18.0 CM	35
HEGAR UT.DILATOR W.SLOPED HDL 1.0 MM	270	HEYWOOD-SMITH, HAEMORRHOIDAL FORCEPS 25.0 CM	276
HEGAR UT.DILATOR W.SLOPED HDL 11.0 MM	270	HIRSCHMANN ANOSCOPE W.OBTURATOR 19X65 MM	253
HEGAR UT.DILATOR W.SLOPED HDL 2.0 MM	270	HIRSCHMANN ANOSCOPE W.OBTURATOR 22X65 MM	253
HEGAR UT.DILATOR W.SLOPED HDL 3.0 MM	270	HIRSCHMANN ANOSCOPE W.OBTURATOR 16X65 MM	253
HEGAR UT.DILATOR W.SLOPED HDL 4.0 MM	270	HIRSCHMANN, ANOSCOPE W. OBTURATOR, Ø 22 X 130 MM	253
HEGAR UT.DILATOR W.SLOPED HDL 5.0 MM	270	HOSEMANN, ARTERY FORCEPS, 1X2 TEETH, STRAIGHT, 21,0 CM	114
HEGAR UT.DILATOR W.SLOPED HDL 6.0 MM	270	HOSEMANN, ARTERY FORCEPS, STRAIGHT, 21,0 CM	114
HEGAR UT.DILATOR W.SLOPED HDL 8.0 MM	270	HUMBY, DERMATOMES, 35,0 CM	11
HEGAR UT.DILATOR W.SLOPED HDL 9.0 MM	270	HUMBY, DERMATOMES, SPARE BLADE	11
HEGAR UT.DILATOR W.SLOPED HDL. 1.5 MM	270	HUNTER SPLINTER FORCEPS CVD 10.5 CM	78
HEGAR UT.DILATOR W.SLOPED HDL.10.0 MM	270	HUNTER SPLINTER FORCEPS STR 10.5 CM	78
HEGAR UT.DILATOR W.SLOPED HDL.10.5 MM	270	HURD LIGATURE NEEDLE LEFT 21.0 CM	150
HEGAR UT.DILATOR W.SLOPED HDL.11.5 MM	270	HURD LIGATURE NEEDLE RIGHT 21.0 CM	150
HEGAR UT.DILATOR W.SLOPED HDL.12.0 MM	270	HURWITZ, TROCER, Ø 12,3 MM	218
HEGAR UT.DILATOR W.SLOPED HDL.12.5 MM	270	HURWITZ, TROCER, Ø 7,3 MM	218
HEGAR UT.DILATOR W.SLOPED HDL.13.0 MM	270	HURWITZ, TROCER, Ø 8,7 MM	218
HEGAR UT.DILATOR W.SLOPED HDL.13.5 MM	270	HYSTEREKTOMY, DISSEC.-SCS. TC, S-SHAPED, 25,5 CM	51
HEGAR UT.DILATOR W.SLOPED HDL.14.0 MM	270	HYSTEREKTOMY, DISSEC.-SCS. TC, S-SHAPED, 25,5 CM	51
HEGAR UT.DILATOR W.SLOPED HDL.14.5 MM	270	INCISION SCISSORS 13,0 CM	32

INCISION SCISSORS 14,5 CM	32	KALLMORGEN, VAGINAL SPECULA, FIG. 2, SET, 90 x 40 MM	265
INCISION SCISSORS 15,5 CM	32	KALLMORGEN, VAGINAL SPECULA, FIG. 2, 90 x 40 MM	265
INSTRUMENT BOXES, LID WITH KNOB, 200X150X25 MM	310	KALT MICRO-NEEDLE HOLDER TC 14.0 CM	133
INSTRUMENT BOXES, LID WITH KNOB, 220X170X50 MM	310	KANTROWITZ DISS.AND LIG.FCPS. CVD 20,0CM	112
INSTRUMENT BOXES, LID WITH KNOB, 260X180X30 MM	310	KANTROWITZ DISS.AND LIG.FCPS. CVD 24,0CM	112
INSTRUMENT BOXES, LID WITH KNOB, 280X200X50 MM	310	KANTROWITZ DISS.AND LIG.FCPS. CVD 28,0CM	112
INSTRUMENT BOXES, LID WITH KNOB, 300X220X30 MM	310	KAYE FACE LIFT, DISSEC.-SCS., SUPERCUT, CURVED, BL/BL, 15,0 CM	56
INSTRUMENT BOXES, LID WITH KNOB, 320X240X50 MM	310	KAYE FACE LIFT, DISSEC.-SCS., SUPERCUT, CURVED, BL/BL, 19,0 CM	56
INSTRUMENT BOXES, LID WITH KNOB, 350X2200X40 MM	310	KELLY FISTULA SCISSORS CURVED 16,0 CM	41
INSTRUMENT BOXES, LID WITH KNOB, 370X270X50 MM	310	KELLY FISTULA SCISSORS CURVED 18,0 CM	41
INSTRUMENT BOXES, LID WITH KNOB, 420X320X50 MM	310	KELLY FISTULA SCISSORS STRAIGHT 16,0 CM	40
INSULINE SYRINGE, LUER, 1 ML	227	KELLY FISTULA SCISSORS STRAIGHT 18,0 CM	40
INSULINE SYRINGE, LUER, 2 ML	227	KELLY FORCEPS CURVED 14,0 CM	101
IOWA TENACULUM FCPS.F.AMNION BLADDER 26	275	KELLY FORCEPS STRAIGHT 14,0 CM	101
IOWA, SUCTION TUBE, 14,0 CM	224	KELLY POLYPUS FORCEPS 32,0 CM	276
IRIS SCISSOR CVD. SH/SH 11,5 CM SC	57	KELLY PROCTOSCOPE W.OBTURATOR 22X140 MM	253
IRIS SCISSOR STR. SH/SH 11,5 CM SC	57	KELLY PROCTOSCOPE W.OBTURATOR 22X200 MM	253
IRIS SCISSORS ANGLED SH/SH 11,5 CM	29	KELLY PROCTOSCOPE W.OBTURATOR 22X50 MM	253
IRIS SCISSORS CVD SH/SH 10,5 CM	28	KELLY PROCTOSCOPE W.OBTURATOR 22X50 MM	253
IRIS SCISSORS CVD SH/SH 11,5 CM	28	KELLY PROCTOSCOPE W.OBTURATOR 22X100 MM	253
IRIS SCISSORS CVD SH/SH 9,0 CM	28	KELLY RETRACTOR 160X38 MM 27,0 CM	180
IRIS SCISSORS LATERALLY CVD SH/SH 11,5CM	29	KELLY RETRACTOR 160X57 MM 27,0 CM	180
IRIS SCISSORS STR SH/SH 10,5 CM	28	KELLY RETRACTOR 190X38 MM 27,0 CM	180
IRIS SCISSORS STR SH/SH 11,5 CM	28	KELLY RETRACTOR 190X57 MM 27,0 CM	180
IRIS SCISSORS STR SH/SH 9,0 CM	28	KELLY, DISSECTING AND LIGATURE FCPS., 19,0 CM	111
IRIS, FINE SCISSORS, CURVED, WITH TC-INSERTS, 11,5 CM	55	KELLY, DISSECTING AND LIGATURE FCPS., 19,0 CM	111
IRIS, SCISSORS, WITH TC-INSERTS STRAIGHT, POINTED, 11,5 CM	55	KELLY, DISSECTING AND LIGATURE FCPS., 19,0 CM	111
ISRAEL RETR. 4 PRONGS 40X40 MM 25,0 CM	173	KELLY, DISSECTING AND LIGATURE FCPS., 22,0 CM	111
ISRAEL RETR. 6 PRONGS 50X60 MM 25,0 CM	173	KELLY, DISSECTING AND LIGATURE FCPS., 22,0 CM	111
ISRAEL RETR. 6 PRONGS 70X70MM 25,0 CM	173	KELLY, DISSECTING AND LIGATURE FCPS., 24,0 CM	111
ISRAEL RETR.5 PRONGS 45X50 MM 25,0 CM	173	KELLY, DISSECTING AND LIGATURE FCPS., 24,0 CM	111
IVES FANSLER, ANOSCOPE, Ø 22 MM	254	KELLY, DISSECTING AND LIGATURE FCPS., 24,0 CM	111
IVES FANSLER, ANOSCOPE, W. COLD LIGHT CARRIER, Ø 22 MM	254	KELLY, DISSECTING AND LIGATURE FCPS., 24,0 CM	111
JABALEY, FINE OP.-SCS., SUPERCUT, STRAIGHT, SH/SH, 13,0 CM	56	KELLY-RANKIN ARTERY FORCEPS CVD 16,0 CM	101
JACKSON BURROWS, SELF-RETAINING RETRACTOR, BLUNT, 17,5 CM	196	KELLY-RANKIN, HAEMOSTATIC FORCEPS STRAIGHT, 16,0 CM	101
JACKSON, VAGINAL SPECULA, FIG. 1, 75 x 38 MM	265	KEVORKIAN, BIOPSY CURETTE 30,0CM	278
JACKSON, VAGINAL SPECULA, FIG. 2, 90 x 38 MM	265	KEVORKIAN, BIOPSY CURETTE, 30,0 CM	278
JACKSON, VAGINAL SPECULA, FIG. 3, 100 x 38 MM	265	KEVORKIAN, BIOPSY CURETTE, 30,0 CM	278
JACOBI LIGATURE NEEDLE 14,0 CM	149	KEVORKIAN-PACIFIC CERVICAL BIOPSY FCPS	288
JACOBS TENAC.FCPS SIDEW.CVD 2X2T. 21,0CM	274	KEVORKIAN-YOUNGE, BIOPSY FORCEPS; 25,4 CM SHAFT, 3 MM X 8 MM BITE	287
JACOBS, UTERINE TENACULUM FORCEPS STRAIGHT, 2 X 2 TEETH, 21,0 CM	274	KEYES, DERMAL PUNCH, Ø 2 MM, 12,0 CM	294
JAMISON, DISSEC.-SCS., SUPERCUT, STRAIGHT, BL/BL, 15,0 CM	57	KEYES, DERMAL PUNCH, Ø 3 MM, 12,0 CM	294
JAMISON, DISSEC.-SCS., SUPERCUT, STRAIGHT, BL/BL, 18,0 CM	57	KEYES, DERMAL PUNCH, Ø 4 MM, 12,0 CM	294
JAMISON, NEEDLE HOLDER, 23,5 CM	127	KEYES, DERMAL PUNCH, Ø 5 MM, 12,0 CM	294
JANET, WOUND A. BLADDER SYRINGE, 100 ML	228	KEYES, DERMAL PUNCH, Ø 6 MM, 12,0 CM	294
JANET, WOUND A. BLADDER SYRINGE, 150 ML	228	KEYES, DERMAL PUNCH, Ø 7 MM, 12,0 CM	294
JANET, WOUND A. BLADDER SYRINGE, 200 ML	228	KEYES, DERMAL PUNCH, Ø 8 MM, 12,0 CM	294
JANET, WOUND A. BLADDER SYRINGE, 50 ML	228	KEYES, DERMAL PUNCHES, SET, W. 6 EXCHANGEABLE WORKING PARTS	294
JANSEN BONE CURETTES CURVED 15,0 CM	300	KIDNEY TRAY, 250 MM STAINLESS STEEL 18/10	309
JANSEN BONE CURETTES STRAIGHT 16,0 CM	300	KIDNEY TRAY, 170 MM STAINLESS STEEL 18/10	309
JANSEN RETRACTOR BLUNT 3X3 PRONGS 10,0CM	188	KIDNEY TRAY, 275 MM STAINLESS STEEL, 18/10	309
JANSEN RETRACTOR SHARP 3X3 PROMGS 10,0CM	188	KIELLAND, OBSTETRECIAL FORCEPS, 41,0 CM	290
JAR, Ø 100 x 175 MM	309	KIELLAND-LUIKART, OBSTETRICAL FORCEPS, 40,0 CM	290
JAR, Ø 100 x 200 MM	309	KILNER PLASTIC SURGERY SCS CVD 15,0 CM	26
JAR, Ø 75 x 130 MM	309	KILNER PLASTIC SURGERY SCS CVD 18,0 CM	26
JAR, Ø 75 x 175 MM	309	KILNER PLASTIC SURGERY SCS CVD 20,0 CM	26
JARCHO, UTERINE TENACULUM FORCEPS, 20,0 CM	273	KILNER PLASTIC SURGERY SCS STR 12,0 CM	26
JEWELER'S FORCEPS NO.3 12,0 CM	80	KILNER PLASTIC SURGERY SCS STR 15,0 CM	26
JEWELER'S FORCEPS NO.4 11,0 CM	80	KILNER PLASTIC SURGERY SCS STR 18,0 CM	26
JEWELER'S FORCEPS NO.5 11,0 CM	80	KILNER PLASTIC SURGERY SCS STR 20,0 CM	26
JEWELER'S FORCEPS NO.7 11,0 CM	80	KILNER, PLASTIC SURGERY SCS CVD 12,0 CM	26
JOBSON-HORNE COTTON APPLICATOR 18,0 CM	216	KILNER, SKIN HOOK, SHARP, 15,0 CM	158
JOHNS HOPKINS BULLDOG CLAMP STR 9,0 CM	94	KIRSCHNER ABDOMINAL RETRACTOR COMPLETE	206
JOHNS HOPKINS BULLDOG CLAMPS STR 4,0 CM	94	KIRSCHNER LIGATURE CONDUCTOR 25,5 CM	153
JOHNS-HOPKINS ARTERY FCPS CVD 20,0 CM	108	KIRSCHNER LIGATURE CONDUCTOR 28,0 CM	153
JOHNS-HOPKINS BULLDOG CLAMP CVD 4,0 CM	94	KIRSCHNER, ABDOMINAL RETRACTOR W. FOLDING FRAME, COMPLETE	206
JOHNS-HOPKINS BULLDOG CLAMP CVD 5,0 CM	94	KIRSCHNER, ABDOMINAL RETRACTOR W. OVAL FRAME, COMPLETE	207
JOHNS-HOPKINS BULLDOG CLAMP CVD 6,5 CM	94	KIRSCHNER, ABDOMINAL RETRACTOR, FOLDING FRAME ONLY, 255X255 MM	206
JOHNS-HOPKINS BULLDOG CLAMP CVD 7,5 CM	94	KIRSCHNER, ABDOMINAL RETRACTOR, FRAME ONLY, 250X250 MM	206
JOHNS-HOPKINS BULLDOG CLAMP CVD 9,0 CM	94	KIRSCHNER, ABDOMINAL RETRACTOR, FRAME ONLY, 300X320 MM	206
JOHNS-HOPKINS BULLDOG CLAMP STR 5,0 CM	94	KIRSCHNER, ABDOMINAL RETRACTOR, FRAME ONLY, 300X380 MM	206
JOHNS-HOPKINS BULLDOG CLAMP STR 6,5 CM	94	KIRSCHNER, ABDOMINAL RETRACTOR, VALVE ONLY, 105X38 MM	207
JOHNS-HOPKINS BULLDOG CLAMP STR 7,5 CM	94	KIRSCHNER, ABDOMINAL RETRACTOR, VALVE ONLY, 43X55 MM	206
JOHNSON, NEEDLE HOLDER, 27,0 CM	127	KIRSCHNER, ABDOMINAL RETRACTOR, VALVE ONLY, 50X65 MM	206
JOLL (FRIEDMAN), VAGINAL-SELF-RETAINING RETRACTOR, SHARP, 15,5 CM	196	KIRSCHNER, ABDOMINAL RETRACTOR, VALVE ONLY, 60X82 MM	207
JONES TOWEL FORCEPS 5,0 CM	86	KIRSCHNER, ABDOMINAL RETRACTOR, VALVE ONLY, 80X90 MM	206
JONES TOWEL FORCEPS 7,0 CM	86	KIRSCHNER, ABDOMINAL RETRACTOR, VALVE ONLY, 90X65 MM	206
JONES TOWEL FORCEPS 9,0 CM	86	KIRSCHNER, ABDOMINAL RETRACTOR, VALVE ONLY, 98X50 MM	207
JONES, TOWEL FORCEPS, WITH TUBE HOLDER, 9,0 CM	86	KIRSCHNER, ABDOMINAL RETRACTOR, VALVE ONLY, 98X95 MM	206
JOSEPH PLASTIC SURGERY SCS CVD 14,0 CM	27	KIRSCHNER-BALFOUR, ABDOMINAL RETRACTOR, VALVE ONLY, 83X82 MM	207
JOSEPH PLASTIC SURGERY SCS STR. 14,0 CM	27	KIRSTEIN, TONSIL SCISSORS, SERRATED, BLUNT/BLUNT, 18,0 CM	35
JUDD-ALLIS INT.TISSUE FCPS 3X4 T.15,0 CM	243	KLEINERT-KUTZ DELICATE HOOK FIG.1 16,0CM	158
JUDD-ALLIS INT.TISSUE FCPS 3X4 T.19,0 CM	243	KLEINERT-KUTZ DELICATE HOOK FIG.2 16,0CM	158
JUDD-MASSON, BLADDER RETRACTOR WITH CENTRAL VALVE	237	KLEINERT-KUTZ DELICATE HOOK FIG.3 16,0CM	158
KAHN, UTERINE TENACULUM FORCEPS, 24,0 CM	273	KLIMA-ROSSEGGER, STERNAL PUNCTURE CANNULA Ø 1,6 X 40 MM	225
KALLMORGEN, VAGINAL RETRACTOR, FIG. 1, 75 x 33 MM	265	KLINKENBERGH-LOTH ARTERY SCISSORS 23,0CM	39
KALLMORGEN, VAGINAL RETRACTOR, FIG. 2, 95 x 33 MM	265	KNAPP DELICATE HOOK SHARP 13,0 CM	160
KALLMORGEN, VAGINAL SPECULA, 17,0 CM, 75 x 39 MM	265	KNAPP, DELICATE HOOK, 1 X 4 TEETH, BLUNT, 13,0 CM	160
KALLMORGEN, VAGINAL SPECULA, FIG. 1, 70 X 40 MM	265	KNOT TIERS 23,0 CM	154
KALLMORGEN, VAGINAL SPECULA, FIG. 1, SET, 70 x 40 MM	265	KNOWLES SCISSORS FOR FINGERS STR 14,0 CM	45



Inhaltsverzeichnis  
Index

KNUTSON CIRCUMCISION INSTRUM.	240	KRISTELLER, VAGINAL SPECULA, 105X28MM,FIG.2	262
KOCHER AT INTEST.CLAMP FCPS. CVD.25.0 CM	247	KRISTELLER, VAGINAL SPECULA, 110X27MM,FIG.1	262
KOCHER AT INTEST.CLAMP FCPS. STR.22.0 CM	247	KRISTELLER, VAGINAL SPECULA, 115X23MM,FIG.1	262
KOCHER AT INTEST.CLAMP FCPS.CVD. 22.0 CM	247	KRISTELLER, VAGINAL SPECULA, 115X29MM,FIG.3	262
KOCHER AT INTEST.CLAMP FCPS.28.0 CM	247	KRISTELLER, VAGINAL SPECULA, 105X18MM, FIG.00	263
KOCHER AT INTEST.CLAMP FCPS.STR. 25.0 CM	247	KRISTELLER, VAGINAL SPECULA, 105X21MM, FIG.0	263
KOCHER AT INTEST.CLAMP FCPS.STR. 28.0 CM	247	KRISTELLER, VAGINAL SPECULA, 105X26MM, FIG.1	262
KOCHER BLADDER RETRACTOR 67 MM 26.0 CM	239	KRISTELLER, VAGINAL SPECULA, 105X33MM, FIG.3	262
KOCHER INT. CLAMP FCPS.STR.ELAST.22.0 CM	246	KRISTELLER, VAGINAL SPECULA, 110X14MM, FIG.00	263
KOCHER INT.CLAMP FCPS CVD ELASTIC 25.0CM	246	KRISTELLER, VAGINAL SPECULA, 110X17MM, FIG.0	263
KOCHER INT.CLAMP FCPS STR ELASTIC 25.0CM	246	KRISTELLER, VAGINAL SPECULA, 110X30MM, FIG.2	262
KOCHER INT.CLAMP FCPS. CVD.ELAST.22.0 CM	246	KRISTELLER, VAGINAL SPECULA, 110X36MM, FIG.3	262
KOCHER INT.CLAMP FCPS. CVD.ELAST.28.0 CM	246	KRISTELLER, VAGINAL SPECULA, 115X22MM, FIG.1	262
KOCHER INT.CLAMP FCPS.STR. ELAST.28.0 CM	246	KRISTELLER, VAGINAL SPECULA, 115X24MM, FIG.2	262
KOCHER LIGATURE CONDUCTOR 15.0 CM	153	KRISTELLER, VAGINAL SPECULA, 115X26MM, FIG.2	262
KOCHER LIGATURE CONDUCTOR 15.0 CM	153	KRISTELLER, VAGINAL SPECULA, 115X32MM, FIG.3	262
KOCHER LIGATURE CONDUCTOR 16.0 CM	153	KRISTELLER, VAGINAL SPECULA, 70X27MM, FIG.1	263
KOCHER LIGATURE CONDUCTOR 18.0 CM	153	KRISTELLER, VAGINAL SPECULA, 80X30MM, FIG.2	263
KOCHER LIGATURE CONDUCTOR W/O EAR 18.0CM	153	KRISTELLER, VAGINAL SPECULA, 90X36MM, FIG.3	263
KOCHER LIGATURE NEEDLE FIG.1 19.0 CM	148	KRISTELLER, VAGINAL SPECULA, FIG. 0, 70 x 15 MM	263
KOCHER LIGATURE NEEDLE FIG.2 19.0 CM	148	KRISTELLER, VAGINAL SPECULA, SET FIG.1	262
KOCHER LIGATURE NEEDLE FIG.3 19.0 CM	148	KRISTELLER, VAGINAL SPECULA, SET FIG.1	262
KOCHER RETRACTOR 22 CM 1 PRONG BLUNT	172	KRISTELLER, VAGINAL SPECULA, SET FIG.2	262
KOCHER RETRACTOR 22 CM 1 PRONG SEMI-SH.	172	KRISTELLER, VAGINAL SPECULA, SET FIG.3	262
KOCHER RETRACTOR 22 CM 2 PRONGS SEMI-SH.	172	KRISTELLER, VAGINAL SPECULA, SET FIG.3	262
KOCHER RETRACTOR 22 CM 2 PRONGS BLUNT	172	KRISTELLER, VAGINAL SPECULA, SET, FIG.0	263
KOCHER RETRACTOR 22 CM 3 PRONGS SEMI-SH.	172	KRISTELLER, VAGINAL SPECULA, SET,17.0 CM, 70 x 15 MM	265
KOCHER RETRACTOR 22 CM 3 PRONGS BLUNT	172	KROENLEIN ARTERY FORCEPS STR 13.0 CM	98
KOCHER RETRACTOR 22 CM 4 PRONGS SEMI-SH.	172	KRONECKER LIGATURE NEEDLE LEFT 15.0 CM	149
KOCHER RETRACTOR 22 CM 4 PRONGS BLUNT	172	KRONECKER LIGATURE NEEDLE RIGHT 15.0 CM	150
KOCHER RETRACTOR 22 CM 4 PRONGS SHARP	171	LAHEY GALL DUCT CLAMP 19.0 CM	114
KOCHER RETRACTOR 22 CM 6 PRONGS SEMI-SH.	172	LAHEY GALL DUCT CLAMP 23.0 CM	114
KOCHER RETRACTOR 22 CM 6 PRONGS BLUNT	172	LAMBOTTE RASPARTORIES 15MM	302
KOCHER RETRACTOR 22 CM 6 PRONGS SHARP	171	LAMBOTTE RASPARTORIES 20MM	302
KOCHER RETRACTOR 22 CM 8 PRONGS SEMI-SH.	172	LAMBOTTE RASPARTORIES 25MM	302
KOCHER RETRACTOR 22 CM 8 PRONGS BLUNT	172	LAMBOTTE, OSTEOTOME 15 MM, 24.0 CM	306
KOCHER RETRACTOR 22 CM 8 PRONGS SHARP	171	LAMBOTTE, OSTEOTOME 20 MM, 24.0 CM	306
KOCHER RETRACTOR 40X18 MM 23.0 CM	176	LAMBOTTE, OSTEOTOME 25 MM, 24.0 CM	306
KOCHER RETRACTOR 60X20 MM 23.0 CM	176	LAMBOTTE, OSTEOTOME 30 MM, 24.0 CM	306
KOCHER RETRACTOR 60X25 MM 23.0 CM	176	LAMBOTTE, OSTEOTOME 38 MM, 24.0 CM	306
KOCHER RETRACTOR 70X25 MM 22.0 CM	179	LAMBOTTE, OSTEOTOME 44 MM, 24.0 CM	306
KOCHER RETRACTOR 75X30 MM 23.0 CM	176	LAMBOTTE, OSTEOTOME 50 MM, 24.0 CM	306
KOCHER RETRACTOR 75X40 MM 23.0 CM	176	LAMBOTTE, OSTEOTOME CURVED, 15 MM, 24.0 CM	306
KOCHER RETRACTOR 80X42 MM 25.0 CM	179	LAMBOTTE, OSTEOTOME CURVED, 20 MM, 24.0 CM	306
KOCHER RETRACTOR 80X50 MM 25.0 CM	179	LAMBOTTE, OSTEOTOME CURVED, 25 MM, 24.0 CM	306
KOCHER RETRACTOR 80X60 MM 25.0 CM	179	LAMBOTTE, OSTEOTOME CURVED, 30 MM, 24.0 CM	306
KOCHER RETRACTOR SHARP 1 PRONG 22.0 CM	171	LAMBOTTE, OSTEOTOME CURVED, 38 MM, 24.0 CM	306
KOCHER RETRACTOR SHARP 2 PRONGS 22.0 CM	171	LAMBOTTE, OSTEOTOME CURVED, 44 MM, 24.0 CM	306
KOCHER RETRACTOR SHARP 3 PRONGS 22.0 CM	171	LAMBOTTE, OSTEOTOME CURVED, 50 MM, 24.0 CM	306
KOCHER-DELICATE ART.FCPS.CVD 1X2T 13 CM	105	LAMBOTTE, OSTEOTOME, 6 MM, 24.0 CM	306
KOCHER-DELICATE ART.FCPS.CVD 1X2T 14 CM	105	LAMBOTTE, OSTEOTOME, CURVED, 6 MM, 24,0 CM	306
KOCHER-DELICATE ART.FCPS.CVD 1X2T 16 CM	105	LAMBOTTE, RASPARTORY 10 MM, 21.0 CM	302
KOCHER-DELICATE ART.FCPS.STR 1X2T 13 CM	105	LANDAU TROCAR 2.0 MM	219
KOCHER-DELICATE ART.FCPS.STR 1X2T 14 CM	105	LANDAU, TROCAR, W. IRRIGATION TUBE, Ø 2.0 MM	219
KOCHER-DELICATE ART.FCPS.STR 1X2T 16 CM	105	LANDAU, VAGINAL SPECULA, BAYONET SHAPED, 100X28 MM	267
KOCHER-LANGENBECK RETRACTOR	175	LANDAU, VAGINAL SPECULA, BAYONET SHAPED, 100X38 MM	267
KOCHER-LANGENBECK RETRACTOR 25X6 MM 21.5 CM	175	LANDOLT FINE SCISSORS MORE CVD 12.5 CM	31
KOCHER-LANGENBECK RETRACTOR 35X11MM 21.5 CM	175	LANDOLT FINE SCISSORS STRAIGHT 12.5 CM	31
KOCHER-LANGENBECK RETRACTOR 35X11MM 21.5 CM	175	LANDOLT FINE SCISSORS STRONG CVD 12,5 CM	31
KOCHER-LANGENBECK RETRACTOR 35X8 MM 21.5 CM	175	LANE STOMACH CLAMP FCPS. CURVED 30,0 CM	250
KOCHER-LANGENBECK RETRACTOR 40X11MM 21.5 CM	175	LANE STOMACH CLAMP FCPS. STR. 30.0 CM	250
KOCHER-LANGENBECK RETRACTOR 70X14MM 21.5 CM	175	LANE TISSUE FORCEPS 1X2 TEETH 14.5 CM	76
KOCHER-LANGENBECK RETRACTOR 80X12MM 21.5 CM	175	LANE TISSUE FORCEPS 1X2 TEETH 20.0 CM	76
KOCHER-LANGENBECK, RETRACTOR, 22X6 MM, 21,5 CM	175	LANE TISSUE FORCEPS 2X3 TEETH 14.5 CM	76
KOCHER-LANGENBECK, RETRACTOR, 25X8 MM, 21,5 CM	175	LANE TISSUE FORCEPS 2X3 TEETH 20.0 CM	76
KOERTE RETRACTOR 26X40 MM 24.0 CM	173	LANE TOWEL FORCEPS 15.0 CM	87
KOERTE RETRACTOR 26X40 MM 24.0 CM	173	LANE TOWEL FORCEPS 18.0 CM	87
KOGAN ENDOSPECULA 3MM, 24CM	269	LANE TOWEL FORCEPS 20.0 CM	87
KOGAN ENDOSPECULA 4MM, 24CM	269	LANE, INTESTINAL AND TISSUE GRASPING FORCEPS, 12,5 CM	242
KOGAN ENDOSPECULA 5MM, 24CM	269	LANE, INTESTINAL AND TISSUE GRASPING FORCEPS, 15,0 CM	242
KOGAN ENDOSPECULUM, 3 MM, W.RATCHET 24.0 CM	269	LANE, INTESTINAL AND TISSUE GRASPING FORCEPS, 19,5 CM	242
KOGAN ENDOSPECULUM, 4 MM, W.RATCHET 24.0 CM	269	LANGE SUTURE FORCEPS 10.0 CM	155
KOGAN ENDOSPECULUM, 5 MM, W.RATCHET 24.0 CM	269	LANGENBECK PERIOST.ELEVATOR 10 MM 20.0CM	301
KÖNIG LIGATURE CONDUCTOR 3 MM 19.5 CM	152	LANGENBECK PERIOST.ELEVATOR 8 MM 20.0 CM	301
KÖNIG LIGATURE CONDUCTOR 5 MM 19.5 CM	152	LANGENBECK PERIOSTEAL RASP.CVD. 19.0 CM	303
KÖNIG LIGATURE CONDUCTOR 7 MM 19.5 CM	152	LANGENBECK RETR. 21.0 CM 30X11 MM GRID	174
KÖNIG, RASPARTORY, 15,5 CM	302	LANGENBECK RETR. 21.0 CM 30X14 MM GRID	174
KRAUSE TROCAR 15.0 CM 3.0 MM	221	LANGENBECK RETR. 21.0 CM 30X16 MM GRID	174
KRAUSE TROCAR 15.0 CM 4 MM	221	LANGENBECK RETR. 21.0 CM 40X11 MM GRID	174
KRAUSE TROCAR 15.0 CM 5.0 MM	221	LANGENBECK RETR. 21.0 CM 50X11 MM GRID	174
KRAUSE TROCAR 15.0 CM 5.5 MM	221	LANGENBECK RETRACTOR 22.0 CM 30X11 MM	174
KRISTELLER VAGINAL SPECULA SET FIG.0	263	LANGENBECK RETRACTOR 22.0 CM 30X14 MM	174
KRISTELLER VAGINAL SPECULA SET FIG.00	263	LANGENBECK RETRACTOR 22.0 CM 30X16 MM	174
KRISTELLER VAGINAL SPECULA SET FIG.1	263	LANGENBECK RETRACTOR 22.0 CM 40X11 MM	174
KRISTELLER VAGINAL SPECULA SET FIG.2	263	LANGENBECK RETRACTOR 22.0 CM 50X11 MM	174
KRISTELLER VAGINAL SPECULA SET FIG.3	263	LANGENBECK RETRACTOR 55X20 MM 21.0 CM	173
KRISTELLER, VAGINAL RETRACTOR, FIG. 0, 75 x 10 MM	263	LANGENBECK RETRACTOR 60X20 MM 21.0 CM	173
KRISTELLER, VAGINAL RETRACTOR, FIG. 1, 75 X 23 MM	263	LANGENBECK RETRACTOR 63X20 MM 21.0 CM	173
KRISTELLER, VAGINAL RETRACTOR, FIG. 2, 85 X 26 MM	263	LANGENBECK, AMPUTATING KNIFE, BLADE LENGTH 5,5 CM, 18,0 CM	10
KRISTELLER, VAGINAL RETRACTOR, FIG. 3, 100 X 32MM	263	LANGENBECK, NEEDLE HOLDER WITH TC 18.0 CM	143

LANGENBECK, NEEDLE HOLDER WITH TC 20.0 CM	143	MAGILL, SUCTION TUBE W. FINGERRING, Ø 3,0 MM	223
LANGENBECK, NEEDLE HOLDER WITH TC 23.0 CM	143	MAGILL, SUCTION TUBE W. FINGERRING, Ø 4,0 MM	223
LANGENBECK-GREEN, RETRACTOR, 16x6 MM, 16,0 CM HANDLE NOT AS ILLUSTRATED IN OUR CAT	161	MAINGOT, HYSTERECTOMY FORCEPS, 1X2 TEETH, 20,0 CM	120
LANGENBECK-GREEN, RETRACTOR, 24x6 MM, 16,0 CM	161	MAINGOT, HYSTERECTOMY FORCEPS, 1X2 TEETH, 25,0 CM	120
LATERAL VAGINAL RETRACTOR 25,0 CM	269	MARTEL FLAP FORCEPS 14,0 CM	97
LAWRENCE ARTERY FORCEPS CVD 28.0 CM	114	MARTIN PELVIMETERS,CM/INCH-SCALE,34.0CM	292
LAWRENCE, NEEDLE HOLDER, SMOOTH, 15,0 CM	126	MARTIN UTERINE PROBES, 30.0CM	277
LEGUEU BLADDER RETRACTOR 35MM 27.0 CM	239	MARTIN, UTERINE PROBE, MALLEABLE, 32,0 CM	277
LEGUEU, BLADDER RETRACTOR	237	MARTINI, BONE CURETTE, FIG.0/1, 14,0 CM	300
LEMPERT, BONE CURETTE FIG.0, 21,5 CM	299	MARTINI, BONE CURETTE, FIG.00/0, 14,0 CM	300
LEMPERT, BONE CURETTE FIG.00, 21,5 CM	299	MARTINI, BONE CURETTE, FIG.1/2, 14,0 CM	300
LEMPERT, BONE CURETTE FIG.000, 21,5 CM	299	MASSON NEEDLE HOLDER 27,0 CM	127
LEMPERT, BONE CURETTE FIG.0000, 21,5 CM	299	MASSON NEEDLE HOLDER TC 27,0 CM	138
LEMPERT, BONE CURETTE FIG.00000, 21,5 CM	299	MATHIEU NEEDLE HOLDER 14,0 CM	129
LERICHE ARTERY FCPS CVD 1X2 T 15,0 CM	102	MATHIEU NEEDLE HOLDER 17,0 CM	129
LERICHE ARTERY FCPS STR 1X2 T 15,0 CM	102	MATHIEU NEEDLE HOLDER 20,0 CM	129
LERICHE ARTERY FORCEPS STR 15,0 CM	102	MATHIEU NEEDLE HOLDER SAFETY RAT. 17,0CM	129
LERICHE FORCEPS CVD 15,0 CM	102	MATHIEU NEEDLE HOLDER SAFETY RAT. 20,0CM	129
LERMOYEZ, TROCARS, Ø 2,0 MM	220	MATHIEU NEEDLE HOLDER TC 14,0 CM	141
LERMOYEZ, TROCARS, Ø 2,5 MM	220	MATHIEU NEEDLE HOLDER TC 17,0 CM	141
LERMOYEZ, TROCARS, Ø 3,0 MM	220	MATHIEU NEEDLE HOLDER TC 20,0 CM	141
LEXER SCISSORS TC CURVED 16,0 CM	47	MATHIEU RECTAL SPECULA 19,5 CM 90X15 MM	252
LEXER SCISSORS TC CURVED 21,0 CM	47	MATHIEU RETRACTOR SET FIG.1+2	168
LEXER SCISSORS TC STRAIGHT 16,0 CM	47	MATHIEU, FOREIGN BODY FORCEPS SERRATED, 28,0 CM	238
LEXER SCISSORS TC STRAIGHT 21,0 CM	47	MATHIEU, FOREIGN BODY FORCEPS SERRATED, 20,0 CM	238
LEXER, DISSEC.-SCS, CURVED, 16,0 CM	25	MATHIEU, NEEDLE HOLDER 14,0 CM	129
LEXER, DISSEC.-SCS, CURVED, 21,0 CM	25	MATHIEU, NEEDLE HOLDER 17,0 CM	129
LEXER, DISSEC.-SCS, STRAIGHT, 16,0 CM	25	MATHIEU, NEEDLE HOLDER WITH TC, 17,0 CM	142
LEXER, DISSEC.-SCS, STRAIGHT, 21,0 CM	25	MATHIEU, NEEDLE HOLDER WITH TC, 20,0 CM	142
LEXER-BABY, DISSECTING SCISSORS CURVED, 10,0 CM	25	MATHIEU, NEEDLE HOLDER WITH TC, 23,0 CM	142
LEXER-BABY, DISSECTING SCISSORS, STRAIGHT, 10,0 CM	25	MATHIEU, VAGINAL RETRACTOR, FIG. 1, 100 x 11-21 MM	267
LICHTENBERG, NEEDLE HOLDER WITH TC, 17,0 CM	142	MATHIEU, VAGINAL RETRACTOR, FIG. 2, 100 x 14-27 MM	267
LICHTENBERG, NEEDLE HOLDER WITH TC, 20,0 CM	142	MATHIEU, VAGINAL SPECULA, FIG. 1, 100 x 13-23 MM	267
LICHTWITZ TROCER 11,0 CM 1,6MM	221	MATHIEU, VAGINAL SPECULA, FIG. 2, 100 x 16-30 MM	267
LICHTWITZ TROCER STRAIGHT 1,8 MM	221	MATHIEU-KOCHER, NEEDLE HOLDER WITH TC, 14,0 CM	141
LIGATURE NEEDLE FLEXIBLE 20,0 CM	147	MATHIEU-KOCHER, NEEDLE HOLDER WITH TC, 17,0 CM	141
LINCOLN VASCULAR SCISSORS CVD 17,0 CM	35	MATHIEU-KOCHER, NEEDLE HOLDER WITH TC, 17,0 CM	141
LINCOLN VASCULAR SCISSORS STR 17,0 CM	35	MATHIEU-KOCHER, NEEDLE HOLDER, 14,0 CM	130
LISTER BANDAGE SCISSORS 1 L.RING 18,5 CM	44	MATHIEU-KOCHER, NEEDLE HOLDER, 17,0 CM	130
LISTER BANDAGE SCISSORS 1 L.RING 21,0 CM	44	MATHIEU-KOCHER, NEEDLE HOLDER, 20,0 CM	130
LISTER BANDAGE SCISSORS ANGLED 11,0 CM	44	MATZENAUER, VAGINAL SPECULA, 100X10 MM	268
LISTER BANDAGE SCISSORS ANGLED 14,0 CM	44	MATZENAUER, VAGINAL SPECULA, 100X20 MM	268
LISTER BANDAGE SCISSORS ANGLED 18,0 CM	44	MATZENAUER, VAGINAL SPECULA, 100X25 MM	268
LISTER BANDAGE SCISSORS ANGLED 20,0 CM	44	MATZENAUER, VAGINAL SPECULA, 125X15 MM	268
LISTER BANDAGE SCISSORS ANGLED 9,0 CM	44	MATZENAUER, VAGINAL SPECULA, 125X20 MM	268
LISTER BANDAGE SCISSORS TC 18,0 CM	55	MATZENAUER, VAGINAL SPECULA, 125X25 MM	268
LISTER SINUS FORCEPS 13,0 CM	88	MATZENAUER, VAGINAL SPECULA, 125X30 MM	268
LISTER SINUS FORCEPS 16,0 CM	88	MATZENAUER, VAGINAL SPECULA, 125X35 MM	268
LISTER SINUS FORCEPS 18,0 CM	88	MATZENAUER, VAGINAL SPECULA, 125X40 MM	268
LISTER-EXCENTRIC SCS.SAW EDGE 16,0 CM	44	MATZENAUER, VAGINAL SPECULA, 90X20 MM	268
LISTER-EXCENTRIC SCS.SAW EDGE 19,0 CM	44	MAYO DISS.SCS TC CVD BL/BL 14,5 CM	47
LISTON, AMPUTATING KNIFE, BLADE LENGTH 22,0 CM	8	MAYO DISS.SCS TC CVD BL/BL 17,0 CM	47
LISTON, AMPUTATING KNIFE, BLADE LENGTH, 17,0 CM	8	MAYO DISS.SCS TC CVD BL/BL 23,0 CM	47
LISTON, AMPUTATING KNIFE, BLADE LENGTH, 20,0 CM	8	MAYO DISS.SCS TC STR BL/BL 14,5 CM	47
LITTAUER, LIGATURE SCISSORS 11,5 CM	33	MAYO DISS.SCS TC STR BL/BL 17,0 CM	47
LITTAUER, LIGATURE SCISSORS 14,0 CM	33	MAYO DISS.SCS TC STR BL/BL 23,0 CM	47
LITTLE RETRACTOR 12X14 MM 20,0 CM	180	MAYO OPER.SCS.CVD.BL/BL 17,0 CM SC	56
LLOYD-DAVIES, LOBECTOMY SCS., CURVED, BL/BL, 27,0 CM	41	MAYO OPER.SCS.STR.BL/BL 17,0 CM SC	56
LOCKHART-MUMMERY PROBE FIG.1	215	MAYO SAFETY PIN 14,0 CM	308
LOCKHART-MUMMERY PROBE FIG.2	215	MAYO UTERINE SCISSORS STR BL/BL 28,0 CM	18
LOCKHART-MUMMERY PROBE FIG.3	215	MAYO, GALL DUCT PROBE, 32,0 CM	235
LOCKHART-MUMMERY PROBE FIG.4	215	MAYO, GALL STONE SCOOPS, DOUBLE-ENDED, 27,0 CM	234
LOCKWOOD-ALLIS, INTESTINAL A. TISSUE GRASPING FORCEPS, 16,0 CM	242	MAYO, GALL STONE SCOOPS, MALLEABLE, FIG. 1, 27,0 CM	234
LOCKWOOD-ALLIS, INTESTINAL A. TISSUE GRASPING FORCEPS, 20,0 CM	242	MAYO, GALL STONE SCOOPS, MALLEABLE, FIG. 2, 27,0 CM	234
LONG CLAMP FORCEPS CVD 1X2 T. 19,0 CM	121	MAYO, OPER.SCS., CURVED, BL/BL, 14,5 CM	18
LORENZ BANDAGE SCISSORS CVD 23,0 CM	45	MAYO, OPER.SCS., CURVED, BL/BL, 17,0 CM	18
LORNA TOWEL FORCEPS 10,0 CM	87	MAYO, OPER.SCS., STRAIGHT, BL/BL, 14,5 CM	18
LORNA TOWEL FORCEPS 13,0 CM	87	MAYO, OPER.SCS., STRAIGHT, BL/BL, 17,0 CM	18
LOVELACE LUNG GRASPING FCPS ST	117	MAYO, OPER.SCS., STRAIGHT, BL/BL, 23,0 CM	18
LOVELACE LUNG GRASPING FORCEPS	117	MAYO, UTERINE SCISSORS, CVD., BL/BL 23,0 CM	18
LOWER ARTERY FCPS CVD 18,0 CM	114	MAYO, UTERINE SCISSORS, CVD., BL/BL 28,0 CM	18
LUER-KOERTE, GALL STONE SCOOP ELASTIC, FIG. 00, 3,4 MM, 32,0 CM	234	MAYO-ADAMS, APPENDECTOMY RETRACTOR 2 X 2 PRONGS, BLUNT, 17,0 CM	190
LUER-KOERTE, GALL STONE SCOOP ELASTIC, FIG. 1, 5,5 MM, 32,0 CM	234	MAYO-ADAMS, APPENDECTOMY RETRACTOR	
LUER-KOERTE, GALL STONE SCOOP ELASTIC, FIG. 3, 8,0 MM, 32,0 CM	234	W. CENTRAL VALVE 42X14 MM, 17,0 CM	198
LUER-KOERTE, GALL STONE SCOOP ELASTIC, FIG. 5, 15,0 MM, 32,0 CM	234	MAYO-BLAKE GALL STONE FCPS 20	232
LUER-KOERTE, GALL STONE SCOOP, ELASTIC, FIG. 0, 4,3 MM, 32,0 CM	234	MAYO-BLAKE GALL STONE FCPS 20	232
LUER-KOERTE, GALL STONE SCOOP, ELASTIC, FIG. 2, 6,7 MM, 32,0 CM	234	MAYO-HEGAR NEEDLE HOLDER 14,0 CM	126
LUER-KOERTE, GALL STONESCOOP ELASTIC, FIG. 4, 11,0 MM, 32,0 CM	234	MAYO-HEGAR NEEDLE HOLDER 16,0 CM	126
LUER-KOERTE, GALLSTONE SCOOP ELASTIC, FIG. 000, 2,8 MM, 32,0 CM	234	MAYO-HEGAR NEEDLE HOLDER 18,0 CM	126
LUER-LOCK, SPECIAL NEEDLE, 0,45 x 20 MM	224	MAYO-HEGAR NEEDLE HOLDER 20,0 CM	126
LUER-LOCK, SPECIAL NEEDLE, 0,50 x 23 MM	224	MAYO-HEGAR NEEDLE HOLDER 24,0 CM	126
LUER-LOCK, SPECIAL NEEDLE, 0,60 x 25 MM	224	MAYO-HEGAR NEEDLE HOLDER 26,0 CM	126
LUER-LOCK, SPECIAL NEEDLE, 0,65 x 28 MM	224	MAYO-HEGAR NEEDLE HOLDER 30,0 CM	126
LUER-LOCK, SPECIAL NEEDLE, 0,70 x 32 MM	224	MAYO-HEGAR NEEDLE HOLDER TC 16,0 CM	135
LUER-LOCK, SPECIAL NEEDLE, 0,80 x 32 MM	224	MAYO-HEGAR NEEDLE HOLDER TC 18,0 CM	135
LUER-LOCK, SPECIAL NEEDLE, 0,90 x 38 MM	224	MAYO-HEGAR NEEDLE HOLDER TC 20,0 CM	135
M.G.H. NEEDLE HOLDER 17,0 CM	125	MAYO-HEGAR NEEDLE HOLDER TC 24,0 CM	135
MAGILL, SUCTION TUBE W. FINGERRING, Ø 1,0 MM	223	MAYO-HEGAR NEEDLE HOLDER TC 26,0 CM	135
MAGILL, SUCTION TUBE W. FINGERRING, Ø 2,0 MM	223	MAYO-HEGAR NEEDLE HOLDER TC 30,0 CM	135
		MAYO-HEGAR, NEEDLE HOLDER WITH TC, 20,0 CM	135

Inhaltsverzeichnis  
Index

MAYO-HEGAR, NEEDLE HOLDER WITH TC, 24,0 CM	135	METZENBAUM SCS TC CVD BL/BL 18.0 CM	48
MAYO-HEGAR, NEEDLE HOLDER WITH TC, 26,0 CM	135	METZENBAUM SCS TC CVD BL/BL 20.0 CM	48
MAYO-HEGAR-DELICATE NEEDLEH.16.0 CM	126	METZENBAUM SCS TC CVD BL/BL 23.0 CM	48
MAYO-HEGAR-DELICATE NEEDLEH.18.0 CM	126	METZENBAUM SCS TC CVD BL/BL 25.0 CM	48
MAYO-HEGAR-DELICATE NEEDLEH.20.0 CM	126	METZENBAUM SCS TC CVD BL/BL 28.0 CM	48
MAYO-NOBLE OPER.SCS CVD BL/BL 17.0 CM	19	METZENBAUM SCS TC CVD BL/BL 30.0 CM	48
MAYO-NOBLE OPER.SCS STR BL/BL 17.0 CM	19	METZENBAUM SCS TC CVD SH/BL 14.5 CM	48
MAYO-ROBSON INTEST.CLAMP FCPS STR.23,0CM	247	METZENBAUM SCS TC CVD SH/BL 18.0 CM	49
MAYO-ROBSON INTEST.CLAMP FCPS CVD 21,0CM	247	METZENBAUM SCS TC CVD SH/BL 20.0 CM	49
MAYO-ROBSON INTEST.CLAMP FCPS CVD 23,0CM	247	METZENBAUM SCS TC CVD SH/BL 23.0 CM	49
MAYO-ROBSON INTEST.CLAMP FCPS CVD 25,0CM	247	METZENBAUM SCS TC CVD SH/BL 25.0 CM	49
MAYO-ROBSON INTEST.CLAMP FCPS STR 21.0CM	247	METZENBAUM SCS TC CVD SH/BL 28.0 CM	49
MAYO-ROBSON INTEST.CLAMP FCPS STR 25,0CM	247	METZENBAUM SCS TC CVD SH/BL 30.0 CM	49
MAYO-ROBSON, INTESTINAL CLAMP FORCEPS, CURVED, WITH NON- TRAUMATIC SERRATION, 21,0 CM	248	METZENBAUM SCS TC CVD SH/SH 14.5 CM	48
MAYO-ROBSON, INTESTINAL CLAMP FORCEPS, CURVED, WITH NON- TRAUMATIC SERRATION, 23,0 CM	248	METZENBAUM SCS TC CVD SH/SH 18.0 CM	49
MAYO-ROBSON, INTESTINAL CLAMP FORCEPS, CURVED, WITH NON- TRAUMATIC SERRATION, 25,0 CM	248	METZENBAUM SCS TC CVD SH/SH 20.0 CM	49
MAYO-ROBSON, INTESTINAL CLAMP FORCEPS, STRAIGHT, WITH NON- TRAUMATIC SERRATION, 21,0 CM	248	METZENBAUM SCS TC CVD SH/SH 23.0 CM	49
MAYO-ROBSON, INTESTINAL CLAMP FORCEPS, STRAIGHT, WITH NON- TRAUMATIC SERRATION, 23,0 CM	248	METZENBAUM SCS TC CVD SH/SH 25.0 CM	49
MAYO-ROBSON, INTESTINAL CLAMP FORCEPS, STRAIGHT, WITH NON- TRAUMATIC SERRATION, 25,0 CM	248	METZENBAUM SCS TC CVD SH/SH 28.0 CM	49
MAYO-STILLE OPER.SCS CVD BL/BL 15.0 CM	19	METZENBAUM SCS TC CVD SH/SH 30.0 CM	49
MAYO-STILLE OPER.SCS CVD BL/BL 17.0 CM	19	METZENBAUM SCS TC STR BL/BL 14.5 CM	48
MAYO-STILLE OPER.SCS CVD BL/BL 19.5 CM	19	METZENBAUM SCS TC STR BL/BL 18.0 CM	48
MAYO-STILLE OPER.SCS CVD BL/BL 21.0 CM	19	METZENBAUM SCS TC STR BL/BL 20.0 CM	48
MAYO-STILLE OPER.SCS STR BL/BL 15.0 CM	19	METZENBAUM SCS TC STR BL/BL 23.0 CM	48
MAYO-STILLE OPER.SCS STR BL/BL 19.5 CM	19	METZENBAUM SCS TC STR BL/BL 25.0 CM	48
MAYO-STILLE OPER.SCS STR BL/BL 21.0 CM	19	METZENBAUM SCS TC STR BL/BL 28.0 CM	48
MAYO-STILLE SCS TC STR BL/BL 15.0 CM	47	METZENBAUM SCS TC STR BL/BL 30.0 CM	48
MAYO-STILLE SCS TC STR BL/BL 17.0 CM	47	METZENBAUM SCS TC STR SH/BL 18.0 CM	49
MAYO-STILLE, OPERATING SCISSOR, BLUNT, STRAIGHT, 17.0 CM	19	METZENBAUM SCS TC STR SH/BL 20.0 CM	49
MC GIVNEY, HAEMORROIDAL GRASPING FORCEPS, 19,0 CM	256	METZENBAUM SCS TC STR SH/BL 23.0 CM	49
MC GIVNEY, HAEMORROIDAL GRASPING FORCEPS, 19,0 CM	256	METZENBAUM SCS TC STR SH/SH 25.0 CM	49
MC GIVNEY, HAEMORROIDAL W. LOADING ATTACHMENT	255	METZENBAUM SCS TC STR SH/SH 28.0 CM	49
MC INDOE CARTILAGE SCISSORS 19,0 CM	39	METZENBAUM SCS TC STR SH/SH 30.0 CM	49
MC INDOE DRESSING FORCEPS 15,0 CM	66	METZENBAUM SCS TC STRAIGHT SH/BL 14.5 CM	48
MC INDOE, DRESSING FCPS, TC. 15.0 CM	83	METZENBAUM SCS TC STRAIGHT SH/SH 14.5 CM	48
MC INDOE, TISSUE FCPS, 1X2 TEETH, SERRATED, 15.0 CM	73	METZENBAUM, NEEDLE HOLDER, 18,0 CM	125
MC LEAN, OBSTETRICAL FORCEPS, 36.0 CM	290	METZENBAUM-BABY CVD BL/BL 11.5 CM	20
MC QUIGG-MIXTER, DISSECTING AND LIGATURE FORCEPS, 22,0 CM	115	METZENBAUM-BABY STR BL/BL 11.5 CM	20
MCDONALD ELEVATOR 19,0CM	301	METZENBAUM-DELICATE BL/BL CVD 14.5 CM	22
MEDICINE CUP 50 CCM	310	METZENBAUM-DELICATE BL/BL CVD 18.0 CM	23
MEEKER ARTERY FORCEPS CVD 18,0 CM	113	METZENBAUM-DELICATE BL/BL CVD 23.0 CM	23
MEEKER ARTERY FORCEPS CVD 28,0 CM	113	METZENBAUM-DELICATE BL/BL CVD 25.0 CM	23
MENGHINI, LIVER BLIND PUNCTURE NEEDLE, Ø1,0 X 35MM	226	METZENBAUM-DELICATE BL/BL CVD 28.0 CM	23
MENGHINI, LIVER BLIND PUNCTURE NEEDLE, Ø1,2 X 100MM	226	METZENBAUM-DELICATE BL/BL CVD 30.0 CM	23
MENGHINI, LIVER BLIND PUNCTURE NEEDLE, Ø1,2 X 70MM	226	METZENBAUM-DELICATE BL/BL STR 14.5 CM	22
MENGHINI, LIVER BLIND PUNCTURE NEEDLE, Ø1,4 X 100MM	226	METZENBAUM-DELICATE BL/BL STR 18.0 CM	22
MENGHINI, LIVER BLIND PUNCTURE NEEDLE, Ø1,6 X 70MM	226	METZENBAUM-DELICATE BL/BL STR 20.0 CM	22
MENGHINI, LIVER BLIND PUNCTURE NEEDLE, Ø1,8 X 100MM	226	METZENBAUM-DELICATE BL/BL STR 23.0 CM	22
MENGHINI, LIVER BLIND PUNCTURE NEEDLE, Ø1,8 X 168MM	226	METZENBAUM-DELICATE BL/BL STR 25.0 CM	22
MENGHINI, LIVER BLIND PUNCTURE NEEDLE, Ø1,0 X 70MM	226	METZENBAUM-DELICATE BL/BL STR 28.0 CM	22
MENGHINI, LIVER BLIND PUNCTURE NEEDLE, Ø1.4 X 168MM	226	METZENBAUM-DELICATE BL/BL STR 30.0 CM	22
MENGHINI, LIVER BLIND PUNCTURE NEEDLE, Ø1.4 X 70MM	226	METZENBAUM-DELICATE SH/SH CVD 18.0 CM	23
METAL CATHETER FOR MEN, 10 CH, 29,0 CM	240	METZENBAUM-DELICATE SH/SH CVD 20.0 CM	23
METAL CATHETER FOR MEN, 12 CH, 29,0 CM	240	METZENBAUM-DELICATE SH/SH CVD 23.0 CM	23
METAL CATHETER FOR MEN, 14 CH, 29,0 CM	240	METZENBAUM-DELICATE SH/SH CVD 25.0 CM	23
METAL CATHETER FOR MEN, 16 CH, 29,0 CM	240	METZENBAUM-DELICATE SH/SH CVD 28.0 CM	23
METAL CATHETER FOR MEN, 18 CH, 29,0 CM	240	METZENBAUM-DELICATE SH/SH CVD 30.0 CM	23
METAL CATHETER FOR MEN, 20 CH, 29,0 CM	240	METZENBAUM-DELICATE SH/SH STR 18.0 CM	23
METAL CATHETER FOR MEN, 22 CH, 29,0 CM	240	METZENBAUM-DELICATE SH/SH STR 20.0 CM	23
METAL CATHETER FOR MEN, 24 CH, 29,0 CM	240	METZENBAUM-DELICATE SH/SH STR 23.0 CM	23
METAL CATHETER FOR MEN, 8 CH, 29,0 CM	240	METZENBAUM-DELICATE SH/SH STR 25.0 CM	23
METAL CATHETER FOR WOMEN, 10 CH, 16,0 CM	240	METZENBAUM-DELICATE SH/SH STR 28.0 CM	23
METAL CATHETER FOR WOMEN, 11 CH, 16,0 CM	240	METZENBAUM-DELICATE SH/SH STR 30.0 CM	23
METAL CATHETER FOR WOMEN, 12 CH, 16,0 CM	240	METZENBAUM-FINO S, DISSEC. SCS., S-SHAPED, BL/BL, 18,0 CM	24
METAL CATHETER FOR WOMEN, 13 CH, 16,0 CM	240	METZENBAUM-FINO S, DISSEC. SCS., S-SHAPED, BL/BL, 20,0 CM	24
METAL CATHETER FOR WOMEN, 14 CH, 16,0 CM	240	METZENBAUM-FINO S, DISSEC. SCS., S-SHAPED, BL/BL, 23,0 CM	24
METAL CATHETER FOR WOMEN, 15 CH, 16,0 CM	240	METZENBAUM-FINO S, DISSEC. SCS., S-SHAPED, SH/SH, 18,0 CM	24
METAL CATHETER FOR WOMEN, 16 CH, 16,0 CM	240	METZENBAUM-FINO S, DISSEC. SCS., S-SHAPED, SH/SH, 20,0 CM	24
METAL CATHETER FOR WOMEN, 18 CH, 16,0 CM	240	METZENBAUM-FINO S, DISSEC. SCS., S-SHAPED, SH/SH, 23,0 CM	24
METAL CATHETER FOR WOMEN, 20 CH, 16,0 CM	240	METZENBAUM-FINO S, DISSEC.-SCS. TC, S-SHAPED, BL/BL, 18,0 CM ILLUSTR. IN CAT.	51
METAL CATHETER FOR WOMEN, 24 CH, 16,0 CM	240	WRONG -TOO MUCH BENDED	51
METAL CATHETER FOR WOMEN, 6 CH, 16,0 CM	240	METZENBAUM-FINO S, DISSEC.-SCS. TC, S-SHAPED, BL/BL, 18,0 CM ILLUSTR. IN CAT.	51
METAL CATHETER FOR WOMEN, 7 CH, 16,0 CM	240	WRONG -TOO MUCH BENDED	51
METAL CATHETER FOR WOMEN, 8 CH, 16,0 CM	240	METZENBAUM-FINO S, DISSEC.-SCS. TC, S-SHAPED, BL/BL, 20,0 CM ILLUSTR. IN CAT.	51
METAL CATHETER FOR WOMEN, 9 CH, 16,0 CM	240	WRONG -TOO MUCH BENDED	51
METZENBAUM DELICATE BL/BL CVD 20.0 CM	23	METZENBAUM-FINO S, DISSEC.-SCS. TC, S-SHAPED, BL/BL, 20,0 CM ILLUSTR. IN CAT.	51
METZENBAUM SCIASS TC CVD BL/BL 11.5 CM	48	WRONG -TOO MUCH BENDED	51
METZENBAUM SCIASS TC STR BL/BL 11.5 CM	48	METZENBAUM-FINO S, DISSEC.-SCS. TC, S-SHAPED, BL/BL, 23.0 CM ILLUSTR. IN CAT.	51
METZENBAUM SCISSOR CVD.BL/BL 14,0 CM SC	56	WRONG -TOO MUCH BENDED	51
METZENBAUM SCISSORS CVD BL/BL 14.5 CM	20	METZENBAUM-FINO S, DISSEC.-SCS. TC, S-SHAPED, BL/BL, 23.0 CM ILLUSTR. IN CAT.	51
METZENBAUM SCISSORS CVD SH/BL 14.5 CM	20	WRONG -TOO MUCH BENDED	51
METZENBAUM SCISSORS CVD SH/SH 14.5 CM	20	METZENBAUM-FINO SCS TC CVD BL18,0CM	50
METZENBAUM SCISSORS STR BL/BL 14.5 CM	20	METZENBAUM-FINO SCS TC CVD BL20,0CM	50
METZENBAUM SCS TC CVD BL/BL 14.5 CM	48	METZENBAUM-FINO SCS TC CVD BL23,0CM	50

METZENBAUM-FINO SCS TC CVD BL25,0CM	50	MICRO RYDER NEEDLE HOLDER TC 13.0 CM	136
METZENBAUM-FINO SCS TC CVD BL28.0CM	50	MICRO RYDER NEEDLE HOLDER TC 15.0 CM	136
METZENBAUM-FINO SCS TC CVD BL30.0CM	50	MICRO RYDER NEEDLE HOLDER TC 18.0 CM	136
METZENBAUM-FINO SCS TC CVD SH20.0CM	50	MICRO RYDER NEEDLE HOLDER TC 20.0 CM	136
METZENBAUM-FINO SCS TC CVDSH 18.0CM	50	MICRO RYDER NEEDLE HOLDER TC 23.0 CM	136
METZENBAUM-FINO SCS TC CVDSH 23.0CM	50	MICRO RYDER NEEDLE HOLDER TC 26.0 CM	136
METZENBAUM-FINO SCS TC CVDSH 25.0CM	50	MICRO SCISSORS 18,0 CM, 125°	60
METZENBAUM-FINO SCS TC CVDSH 28.0CM	50	MICRO SCISSORS 18,0 CM, 125° ANGLED	60
METZENBAUM-FINO SCS TC CVDSH 30.0CM	50	MICRO SCISSORS 18,0 CM, 25°	60
METZENBAUM-FINO SCS TC STR BL20.0CM	50	MICRO SCISSORS 18,0 CM, 25° ANGLED	60
METZENBAUM-FINO SCS TC STR BL23.0CM	50	MICRO SCISSORS 18,0 CM, 45°	60
METZENBAUM-FINO SCS TC STR BL25.0CM	50	MICRO SCISSORS 18,0 CM, 45° ANGLED	60
METZENBAUM-FINO SCS TC STR BL28.0CM	50	MICRO SCISSORS 18,0 CM, 60°	60
METZENBAUM-FINO SCS TC STR BL30.0CM	50	MICRO SCISSORS 18,0 CM, 60° ANGLED	60
METZENBAUM-FINO SCS TC STR SH18.0CM	50	MICRO SCISSORS 18,0 CM, 90°	60
METZENBAUM-FINO SCS TC STR SH20.0CM	50	MICRO SCISSORS 18,0 CM, 90° ANGLED	60
METZENBAUM-FINO SCS TC STR SH23.0CM	50	MICRO-ADSON DRESS. FORCEPS 12.0 CM	66
METZENBAUM-FINO SCS TC STR SH25.0CM	50	MICRO-ADSON DRESS. FORCEPS 15.0 CM	66
METZENBAUM-FINO SCS TC STR SH28.0CM	50	MICRO-ADSON, DISSECTING AND LIGATURE FORCEPS, 14.0 CM	108
METZENBAUM-FINO SCS TC STR SH30.0CM	50	MICRO-ADSON, TISSUE FORCEPS 1 X 2 TEETH, Ø 0.6 MM, 12.0 CM	71
METZENBAUM-FINO SCS TC STRBL 18.0CM	50	MICRO-ADSON, TISSUE FORCEPS 1 X 2 TEETH, Ø 0.6 MM, 15.0 CM	71
METZENBAUM-FINO TC CVD BL/BL 14.5 CM	49	MICRO-FORCEPS, SELFRETAINING, SMOOTH, 10.0 CM	78
METZENBAUM-FINO TC CVD SH/SH 14.5 CM	49	MICRO-MOSQUITO ART.FCPS 1X2 CVD 12.0 CM	101
METZENBAUM-FINO TC STR BL/BL 14.5 CM	49	MICRO-MOSQUITO ART.FCPS 1X2 STR 10.0 CM	101
METZENBAUM-FINO TC STR SH/SH 14.5 CM	49	MICRO-MOSQUITO ART.FCPS 1X2 STR 12.0 CM	101
METZENBAUM-FINO, DISSEC.-SCS., SUPERCUT, CURVED, BL/BL, 14.5 CM	56	MICRO-MOSQUITO ARTERY FORCEPS CVD 10.0CM	101
METZENBAUM-FINO, DISSEC.-SCS., SUPERCUT, CURVED, BL/BL, 18.0 CM	56	MICRO-MOSQUITO FCPS 1X2 CVD 10.0 CM	101
METZENBAUM-FINO, DISSEC.-SCS., SUPERCUT, CURVED, BL/BL, 20.0 CM	56	MICRO-MOSQUITO FORCEPS CVD 12.0CM	101
METZENBAUM-FINO, DISSEC.-SCS., SUPERCUT, CURVED, BL/BL, 23.0 CM	56	MICRO-MOSQUITO FORCEPS STR 10.0CM	101
METZENBAUM-LAHEY, DISSEC. SCS. TC, CURVED, BL/BL, 14.0 CM	50	MICRO-MOSQUITO FORCEPS STR 12.0CM	101
METZENBAUM-LAHEY, DISSEC. SCS., CURVED, BL/BL, 14.0 CM	24	MICRO-NEEDLE HOLDER, CURVED, 0,4 MM JAW, 14,0 CM	132
METZENBAUM-NELSON SCISSORS CVD. 18.0 CM SUPERCUT	56	MICRO-NEEDLE HOLDER, CURVED, 18,5 CM	131
METZENBAUM-NELSON SCS CVD 20.0 CM SC	56	MICRO-NEEDLE HOLDER, CURVED, W. RATCHET, 0,4 MM JAW, 14,0 CM	132
METZENBAUM-NELSON SCS CVD BL/BL 18.0 CM	21	MICRO-NEEDLE HOLDER, ROUND HANDLE Ø 10 MM, CURVED, 0,5 MM JAW, 14,0 CM	132
METZENBAUM-NELSON SCS CVD BL/BL 20.0 CM	21	MICRO-NEEDLE HOLDER, ROUND HANDLE Ø 10 MM, W. RATCHET, CURVED, 0,5 MM JAW, 14,0 CM	132
METZENBAUM-NELSON SCS CVD BL/BL 23.0 CM	21	MICRO-NEEDLE HOLDER, ROUND HANDLE Ø 8 MM, CURVED, 0,4 MM JAW, 13,0 CM	132
METZENBAUM-NELSON SCS CVD BL/BL 25.0 CM	21	MICRO-NEEDLE HOLDER, ROUND HANDLE Ø 8 MM, W. RATCHET, CURVED, 0,4 MM JAW, 13,0 CM	132
METZENBAUM-NELSON SCS CVD BL/BL 28.0 CM	21	MICRO-NEEDLE HOLDER, STRAIGHT, 0,4 MM JAW, 14,0 CM	132
METZENBAUM-NELSON SCS CVD BL/BL 30.0 CM	21	MICRO-NEEDLE HOLDER, STRAIGHT, 18,5 CM	131
METZENBAUM-NELSON SCS CVD SH/BL 18.0 CM	21	MICRO-NEEDLE HOLDER, WITH RATCHET, CURVED, 18,5 CM	131
METZENBAUM-NELSON SCS CVD SH/BL 20.0 CM	21	MICRO-NEEDLE HOLDER, WITH RATCHET, STRAIGHT, 18,5 CM	131
METZENBAUM-NELSON SCS CVD SH/BL 23.0 CM	21	MICRO-SCS., FLAT-HANDLE, ANGLED, SH/SH, 18,5 CM	59
METZENBAUM-NELSON SCS CVD SH/BL 25.0 CM	21	MICRO-SCS., FLAT-HANDLE, CURVED, SH/SH, 18,5 CM	59
METZENBAUM-NELSON SCS CVD SH/BL 28.0 CM	21	MICRO-SCS., FLAT-HANDLE, STRAIGHT, SH/SH, 18,5 CM	59
METZENBAUM-NELSON SCS CVD SH/BL 30.0 CM	21	MIDDELDORPF RETRACTOR 14X17 MM 21.5 CM	177
METZENBAUM-NELSON SCS CVD SH/SH 18.0 CM	22	MIDDELDORPF RETRACTOR 14X7 MM 21.5 CM	177
METZENBAUM-NELSON SCS CVD SH/SH 20.0 CM	22	MIDDELDORPF RETRACTOR 20X22 MM 22.0 CM	177
METZENBAUM-NELSON SCS CVD SH/SH 23.0 CM	22	MIDDELDORPF RETRACTOR 20X22 MM 22.0 CM	177
METZENBAUM-NELSON SCS CVD SH/SH 25.0 CM	22	MIDDELDORPF RETRACTOR 26X30 MM 23.5 CM	177
METZENBAUM-NELSON SCS CVD SH/SH 28.0 CM	22	MIDDELDORPF RETRACTOR 26X30 MM 23.5 CM	177
METZENBAUM-NELSON SCS CVD SH/SH 30.0 CM	22	MIDDELDORPF, RETRACTOR, 40x45 MM, 25,5 CM	178
METZENBAUM-NELSON SCS STR BL/BL 18.0 CM	21	MIDDELDORPF, RETRACTOR, 40x50 MM, 25,5 CM	178
METZENBAUM-NELSON SCS STR BL/BL 20.0 CM	21	MIDDELDORPF, RETRACTOR, 55x70 MM, 25,5 CM	178
METZENBAUM-NELSON SCS STR BL/BL 23.0 CM	21	MIKULICZ PERIT.CLAMP-FCPS 1X2 T 18.0 CM	118
METZENBAUM-NELSON SCS STR BL/BL 25.0 CM	21	MIKULICZ PERIT.CLAMP-FCPS 1X2 T. 20.0 CM	118
METZENBAUM-NELSON SCS STR BL/BL 28.0 CM	21	MIKULICZ RETRACTOR 120X50 MM 26.0 CM	181
METZENBAUM-NELSON SCS STR BL/BL 30.0 CM	21	MIKULICZ RETRACTOR 155X50 MM 26.0 CM	181
METZENBAUM-NELSON SCS STR SH/BL 18.0 CM	21	MIKULICZ RETRACTOR 85X35 MM 26.0 CM	181
METZENBAUM-NELSON SCS STR SH/BL 20.0 CM	21	MIKULICZ RETRACTOR 90X50 MM 26.0 CM	181
METZENBAUM-NELSON SCS STR SH/SH 23.0 CM	21	MILAN BIOPSY CURETTE 7MM, 28.0CM	278
METZENBAUM-NELSON SCS STR SH/SH 25.0 CM	22	MILAN BIOPSY CURETTE 9MM, 28.0CM	278
METZENBAUM-NELSON SCS STR SH/SH 28.0 CM	22	MILAN BIOPSY CURETTES 4MM, 28.0CM	278
METZENBAUM-NELSON SCS STR SH/SH 30.0 CM	22	MILKULICZ, SIGMOID ANASTOMOSIS FORCEPS, 19,0 CM	251
METZENBAUM-NELSON SCS CVD. 23.0 CM SC	56	MILLIGAN, SELF-RETAINING RETRACTOR, 3x3 PRONGS, SHARP, 13,0 CM	192
MEYERDING RETRACTOR 18CM 7X4MM	162	MILLIN, BLADDER NECK SPREADER 29.5 CM	238
MEYERDING RETRACTOR 18CM 7X4MM	162	MILLIN, BLADDER RETRACTOR CENTRAL VALVE 120 X 45 MM	237
MEYERDING RETRACTOR 18CM 10X3MM	162	MILLIN, BLADDER RETRACTOR LATERAL VALVES 57 X 25 MM	237
MEYERDING RETRACTOR 18CM 10X4MM	162	MILLIN, BLADDER RETRACTOR LATERAL VALVES 80 X 25 MM	237
MEYERDING RETRACTOR 18CM 16X5MM	162	MILLIN, BLADDER RETRACTOR, COMPLETE 2 VALVES 57 X 25 MM, 2 VALVES 80 X 25 MM 1 CENTRAL VALVE 120 X 45 MM	237
MEYERDING RETRACTOR 18CM 18X7MM	162	MILLIN, BLADDER RETRACTOR, ONLY 21,5 CM	237
MEYERDING RETRACTOR 50X16 MM 22.5 CM	183	MILLIN, CAPSULE FORCEPS FOR RETROPUBIC PROSTATECTOMY 24,0 CM	238
MEYERDING RETRACTOR 75X25 MM 22.5 CM	183	MILLIN, CAPSULE FORCEPS, ATRAUMATIC, 24,0 CM	238
MEYERDING RETRACTOR 90X50 MM 22.5 CM	183	MILLIN, LIGATURE CARRYING FORCEPS 24,0 CM	238
MICHEL CLIP FORCEPS 12.0 CM	154	MILLIN, PROSTATIC LOBE HOLDING FORCEPS FOR ANTERIOR LOBES, 23,0 CM	238
MICHEL CLIPS 10PACK = 1000 EA 12 X 3 MM	155	MINI-GEMINI, DISSECTING AND LIGATURE FCPS., 18,0 CM	112
MICHEL CLIPS 10PACK = 1000 EA 14 X 3 MM	155	MINI-GEMINI, DISSECTING AND LIGATURE FCPS., 22,0 CM	112
MICHEL CLIPS 10PACK =1000 EA 11 X 2 MM	155	MINI-GEMINI, DISSECTING AND LIGATURE FCPS., 25,0 CM	112
MICHEL CLIPS 10PACK =1000 EA 16 X 3 MM	155	MINI-GEMINI, DISSECTING AND LIGATURE FCPS., 28,0 CM	112
MICHEL CLIPS 10PACK =1000 EA 18 X 3 MM	155	MINI-LANGENBECK RETRACTOR 10X6 MM 16.0CM	162
MICHEL CLIPS 10PACK =1000 EA 20 X 3 MM	155	MINI-LANGENBECK RETRACTOR 17X5 MM 16.0CM	162
MICHEL CLIPS 10PACK =1000 EA 22 X 3 MM	155	MINI-LANGENBECK RETRACTOR 20X6 MM 16.0CM	162
MICHEL CLIPS 10PACK =1000 EA 7.5 X 1.75	155	MINI-LANGENBECK RETRACTOR 22X8 MM 16.0CM	162
MICHEL SUTURE FORCEPS 12.0 CM	155	MINI-ROUX, RETRACTOR, 14,0 CM	168
MICHEL, SUTURE INSTRUMENTS SET, COMPLETE	155	MINI-TOWNSEND, CERVICAL BIOPSY AND SPECIMEN FORCEPS, 21,0 CM	288
		MIXING BOWL 116 x 50 MM	309

## Inhaltsverzeichnis Index

MIXING BOWL 128 x 55 MM	309	NELATON PROBE 16.0 CM	214
MIXING BOWL 147 x 65 MM	309	NELSON TROCER FIG.1, Ø 7.5 MM 21.0 CM	220
MIXING BOWL 40 x 19 MM	309	NELSON TROCER FIG.2, Ø 9.5 MM 21.0 CM	220
MIXING BOWL 61 x 30 MM	309	NELSON TROCER FIG.3, Ø 11.0 MM 21.0 CM	220
MIXING BOWL 80 x 40 MM	309	NELSON TROCER FIG.4, Ø 12.5 MM 21.0 CM	220
MIXTER ARTERY FORCEPS FIG.1 22.0 CM	114	NELSON, GRASPING FORCEPS 15,0 CM	75
MIXTER ARTERY FORCEPS CVD 15.5 CM	114	NELSON, GRASPING FORCEPS 20,0 CM	75
MIXTER FORCEPS FIG.2 25.0 CM	114	NELSON, GRASPING FORCEPS 23,0 CM	75
MIXTER FORCEPS FIG.3 28.0 CM	114	NERVE DISSECTING SCISSORS CVD 15.0 CM	27
MIXTER GALL STONE FCPS 22CM	232	NERVE DISSECTING SCISSORS STR 15.0 CM	27
MIXTER OPERAT.AND GYN.SCISS. CVD 15.5 CM	25	NON-TRAUMATIC HAEMORRHOIDAL FORCEPS 25CM	97
MIXTER OPERAT.AND GYN.SCISS. STR 15.5 CM	25	NON-TRAUMATIC HAEMORRHOIDAL FORCEPS 27CM	97
MIXTER, DISSECTING FORCEPS, CVD, 19.0 CM	113	NORFOLK/NORWICH, SELF-RETAINING RETRACTOR, 4x5 PRONGS, BLUNT, 22,0 CM	196
MIXTER, DISSECTING FORCEPS, CVD, 22.0 CM	113	NORTHBENT LIGATURE SCISSORS CVD 12.5 CM	34
MIXTER, DISSECTING FORCEPS, CVD, 23.0CM	113	NOTO POLYPUS FORCEPS 27.5 CM	276
MIXTER-O'SHAUGNESSY ART.FCPS CVD 15.5 CM	113	NOVAK, SUCTION BIOPSY CURETTE, Ø 4.0 MM, 23.0 CM	278
MIXTER-O'SHAUGNESSY ART.FCPS CVD,19.0CM	113	OCHSNER ENT TROCER 14 CHARR.	220
MOCK, IRRIGATION CANNULA, 6,0 CM	224	OCHSNER TROCER 12 CHARR.	220
MOD.BONN SCISSORS CVD 8.0 CM	30	OCHSNER TROCER 16 CHARR.	220
MOD.BONN SCISSORS STR 8.0 CM	30	OCHSNER TROCER 20 CHARR.	220
MOD.USA TISSUE FCPS 1X2 TEETH 12.0 CM	71	OCHSNER, GALL DUCT PROBE, 35,0 CM	235
MOD.USA TISSUE FCPS 1X2 TEETH 13.0 CM	71	OCHSNER-KOCHER ART.FCPS.CVD 16.0 CM	106
MOD.USA TISSUE FCPS 1X2 TEETH 14.5 CM	71	OCHSNER-KOCHER ART.FCPS.CVD 26.0 CM	106
MOD.USA TISSUE FCPS 1X2 TEETH 15.5 CM	71	OCHSNER-KOCHER ART.FCPS.CVD 30.0 CM	106
MOD.USA TISSUE FCPS 1X2 TEETH 18.0 CM	71	OCHSNER-KOCHER ART.FCPS.STR 24.0 CM	106
MOD.USA TISSUE FCPS 1X2 TEETH 21.0 CM	71	OCHSNER-KOCHER ART.FCPS.STR 26.0 CM	106
MOD.USA TISSUE FCPS 1X2 TEETH 25.0 CM	71	OCHSNER-KOCHER ART-FCPS.STR 16.0 CM	106
MOD.USA TISSUE FCPS 1X2 TEETH 31.0 CM	71	OCHSNER-KOCHER ART-FCPS.STR 22.0 CM	106
MOD.USA TISSUE FCPS 2X3 TEETH 13.0 CM	71	OCHSNER-KOCHER ART-FCPS.STR 30.0 CM	106
MOD.USA TISSUE FCPS 2X3 TEETH 14.5 CM	71	OCHSNER-KOCHER FCPS CVD 18,0 CM	106
MOD.USA TISSUE FCPS 2X3 TEETH 15.5 CM	71	OCHSNER-KOCHER FCPS. CVD. 14,0 CM	106
MOD.USA TISSUE FORCEPS 2X3 TEETH 12.0 CM	71	OCHSNER-KOCHER FCPS. STR. 14,0 CM	106
MOD.USA TISSUE FORCEPS 2X3 TEETH 18.0 CM	71	OCHSNER-KOCHER FCPS.CVD 20.0 CM	106
MOD.USA TISSUE FORCEPS 2X3 TEETH 21.0 CM	71	OCHSNER-KOCHER FCPS.CVD 22.0 CM	106
MOD.USA TISSUE FORCEPS 2X3 TEETH 25.0 CM	71	OCHSNER-KOCHER FCPS.CVD 24.0 CM	106
MOD.USA TISSUE FORCEPS 2X3 TEETH 31.0 CM	71	OCHSNER-KOCHER FCPS.STR 18.0 CM	106
MOD.USA UMBILICAL SCISSORS 10.5 CM	43	OCHSNER-KOCHER FCPS.STR 20.0 CM	106
MOD.WIEN LIGATURE CATCHER 23.5 CM	154	O'CONNOR DELICATE HOOK 16.0 CM	158
MOLLISON RETRACTOR SHARP 15.0 CM	190	OLIVE ONLY	222
MORGAN, PROCTOSCOPE, Ø 17 X 65 MM	254	OLSEN-HEGAR NEEDLE HOLDER/SCS 14.0 CM	128
MORGAN, PROCTOSCOPE, Ø 17 X 80 MM	254	OLSEN-HEGAR NEEDLE HOLDER/SCS 17.0 CM	128
MORGAN, PROCTOSCOPE, Ø 20 X 65 MM	254	OLSEN-HEGAR NEEDLE HOLDER/SCS 19.0 CM	128
MORGAN, PROCTOSCOPE, Ø 20 X 80 MM	254	OLSEN-HEGAR NEEDLE HOLDER/SCS. TC 14 CM	140
MORGAN, PROCTOSCOPE, Ø 24 X 65 MM	254	OLSEN-HEGAR NEEDLE HOLDER/SCS. TC 17 CM	140
MORGAN, PROCTOSCOPE, Ø 24 X 80 MM	254	OLSEN-HEGAR, NEEDLE HOLDER/SCS., 14,0 CM	128
MORRIS, RETRACTOR, 127x40 MM, 32,0 CM	181	OLSEN-HEGAR, NEEDLE HOLDER/SCS., WITH TC, 18,0 CM	140
MORRIS, RETRACTOR, 127x62 MM, 32,0 CM	181	OP.SCISSORS GRAZIL CVD BL/BL 13.0 CM	17
MOYNIHAN HYSTERECTOMY FORCEPS 23.0 CM	120	OP.SCISSORS GRAZIL CVD BL/BL 14.5 CM	17
MOYNIHAN, GALL STONE PROBE AND SCOOP, 34.0 CM	234	OP.SCISSORS GRAZIL CVD SH/BL 13.0 CM	17
MUSEUX, UTERINE TENACULUM FORCEPS, 2X2 TEETH, 10 MM, CURVED, 24,0 CM	275	OP.SCISSORS GRAZIL CVD SH/BL 14.5 CM	17
MUSEUX, UTERINE TENACULUM FORCEPS, 2X2 TEETH, 10 MM, CURVED, 24,0 CM	275	OP.SCISSORS GRAZIL CVD SH/SH 13.0 CM	18
MUSEUX, UTERINE TENACULUM FORCEPS, 2X2 TEETH, 6 MM, CURVED, 24,0 CM	275	OP.SCISSORS GRAZIL CVD SH/SH 14.5 CM	18
MUSEUX, UTERINE TENACULUM FORCEPS, 2X2 TEETH, 6 MM, CURVED, 24,0 CM	275	OP.SCISSORS GRAZIL STR BL/BL 13.0 CM	17
MUSEUX, UTERINE TENACULUM FORCEPS, 2X2 TEETH, 8 MM, CURVED, 24,0 CM	275	OP.SCISSORS GRAZIL STR BL/BL 13.0 CM	18
MUSEUX, UTERINE TENACULUM FORCEPS, 2X2 TEETH, 8 MM, CURVED, 24,0 CM	275	OP.SCISSORS GRAZIL STR BL/BL 14.5 CM	17
MUSEUX, UTERINE TENACULUM FORCEPS, 2X2 TEETH, 8 MM, CURVED, 24,0 CM	275	OP.SCISSORS GRAZIL STR SH/BL 13.0 CM	17
MYRTLE LEAF PROBE 11,5 CM	214	OP.SCISSORS GRAZIL STR SH/BL 14.5 CM	17
MYRTLE LEAF PROBE 13,0 CM	214	OP.SCISSORS GRAZIL STR SH/SH 14.5 CM	18
MYRTLE LEAF PROBE 14.5 CM	214	OPERATING KNIFE, FIG.10, SOLID HANDLE, 17,0 CM	6
MYRTLE LEAF PROBE, 16,0 CM	214	OPERATING KNIFE, FIG.12, SOLID HANDLE, 17,0 CM	6
MYRTLE LEAF PROBE, 18,0 CM	214	OPERATING KNIFE, FIG.14, SOLID HANDLE, 17,0 CM	6
MYRTLE LEAF PROBE, 20,0 CM	214	OPERATING KNIFE, FIG.16, SOLID HANDLE, 17,0 CM	6
NABATOFF VARICOSE VEIN PROBE SET COMPL.	217	OPERATING KNIFE, FIG.18, SOLID HANDLE, 17,0 CM	6
NABATOFF, CABLE FLEXIBLE STAINLESS	217	OPERATING SCISSORS, STANDARD STRAIGHT, BLUNT/BLUNT, 11.5 CM	14
NABATOFF, HANDLE ONLY	217	OSTEOTOME 10MM 13,5CM	304
NABATOFF, METAL-CASE ONLY	217	OSTEOTOME 12MM 13,5CM	304
NABATOFF, OLIVE ONLY, 12,0 MM	217	OSTEOTOME 14MM 13,5CM	304
NABATOFF, OLIVE ONLY, 6,0 MM	217	OSTEOTOME 16MM 13,5CM	304
NABATOFF, OLIVE ONLY, 9,0 MM	217	OSTEOTOME, 8MM, 13,5 CM	304
NABATOFF, PROBE TIP PLASTIC MATERIAL	217	O'SULLIVAN-O'CONNOR ABDOMINAL RETRACTOR	205
NABATOFF, PROBE TIP ONLY METAL	217	O'SULLIVAN-O'CONNOR BLADE 110X70 MM	205
NAEGELE, OBSTETRICAL FORCEPS, 36,0 CM	290	O'SULLIVAN-O'CONNOR FRAME	205
NAEGELE, OBSTETRICAL FORCEPS, 40,0 CM	290	OVERHOLT ART.FCPS S-SHAPED 21.0 CM	109
NAGER LIGATURE NEEDLE 24.0 CM	150	OVERHOLT ART.FCPS S-SHAPED 21.5 CM	109
NAIL NIPPER FORCEPS, 13,0 CM	296	OVERHOLT ART.FCPS.S-SHAPED 18,5 CM	109
NAIL NIPPER FORCEPS, 13,5 CM	296	OVERHOLT ART.FCPS.S-SHAPED 20,5 CM	109
NAIL NIPPER FORCEPS, WITH LOCK, STRAIGHT BLADES, 14,0 CM	296	OVERHOLT-GEISSENDOERFER FIG.1 21.0 CM	110
NAIL NIPPER FORCEPS, WITH LOCK, CURVED BLADES, 14,0 CM	296	OVERHOLT-GEISSENDOERFER FIG.1 27.0 CM	110
NEEDLE CASE 65 MM	310	OVERHOLT-GEISSENDOERFER FIG.2 21.0 CM	110
NEEDLE CASE, INSERT ONLY, Ø 65 MM	310	OVERHOLT-GEISSENDOERFER FIG.2 27.0 CM	110
NEEDLE HOLDER, SWEDISH PATTERN, WITH TC, 15,0 CM	137	OVERHOLT-GEISSENDOERFER FIG.3 21.0 CM	110
NEEDLE HOLDER, SWEDISH PATTERN, WITH TC, 17,0 CM	137	OVERHOLT-GEISSENDOERFER FIG.3 27.0 CM	110
NEEDLE HOLDER, SWEDISH PATTERN, WITH TC, 20,0 CM	137	OVERHOLT-GEISSENDOERFER FIG.4 21.0 CM	110
NEEDLE LARGE	149	OVERHOLT-GEISSENDOERFER FIG.4 27.0 CM	110
NEEDLE MEDIUM	149	OVERHOLT-GEISSENDOERFER FIG.5 21.0 CM	110
NEEDLE SMALL	149	OVERHOLT-GEISSENDOERFER FIG.5 27.0 CM	110
NEGUS GALL DUCT CLAMP FIG.1 19.0 CM	107	OVERHOLT-GEISSENDOERFER FIG.6 21.0 CM	110
NEGUS GALL DUCT CLAMP FIG.2 19.0 CM	107	OVERHOLT-GEISSENDOERFER FIG.6 27.0 CM	110
NEIVERT NEEDLE HOLDER SMOOTH JAWS 13.0CM	124	OVERHOLT-GEISSENDOERFER FIG.7 21.0 CM	110

OVERHOLT-GEISSENDOERFER FIG.7 27.0 CM	110	PRATT FISTULA HOOK 21,0 CM FIG.2	256
OVERHOLT-MIXTER FORCEPS CVD 21.0 CM	108	PRATT FISTULA HOOK 21,0 CM FIG.3	256
PAR TYPE, FINE DISSEC. SCS., SUPERCUT, CURVED, BL/BL, 12.0 CM	58	PRATT HAEMORRHOIDAL FORCEPS 15,0 CM	98
PAR TYPE, FINE DISSEC. SCS., SUPERCUT, STRAIGHT, BL/BL, 12.0 CM	58	PRATT SET OF 8 DILAT. 4.5/5-13.6/14.3MM	272
PARKER RETRACTOR SET SMALL FIG.1+2	168	PRATT UTERINE DILAT.F.37/39, 12.3/13MM	272
PARKER-LANGENBECK US-ARMY SET FIG.1+2	169	PRATT UTERINE DILAT.F.41/43, 13.6/14.3MM	272
PARTSCH BONE CHISEL WIDTH 3 MM 13.5 CM	304	PRATT UTERINE DILAT.FIG.33/35,11/11.6MM	272
PARTSCH BONE CHISEL WIDTH 4 MM 13.5 CM	304	PRATT UTERINE DILATOR F.17/19,5.6/6.3MM	272
PARTSCH BONE CHISEL WIDTH 5 MM 13.5 CM	304	PRATT UTERINE DILATOR F.29/31,9.6/10.3	272
PARTSCH BONE CHISEL WIDTH 6 MM 13.5 CM	304	PRATT UTERINE DILATORS F.13/15, 4.5/5MM	272
PARTSCH BONE GOUGE WIDTH 3 MM 13.5 CM	304	PRATT UTERINE DILATORS F.21/23, 7/7.6MM	272
PARTSCH BONE GOUGE WIDTH 4 MM 13.5 CM	304	PRATT UTERINE DILATORS F.25/27, 8.3/9MM	272
PARTSCH BONE GOUGE WIDTH 5 MM 13.5 CM	304	PRATT VULSELLUM FORCEPS 4X4 T. 28.0 CM	275
PARTSCH BONE GOUGE WIDTH 6 MM 13.5 CM	304	PRESBYTERIAN CLAMP 16.5 CM	91
PARTSCH MALLET 200GR LEAD FILLED 18.0 CM	306	PRESBYTERIAN TUBING CLAMP 18.0 CM	91
PAYR INT.CRUSHING CLAMP W.PIN 21.0 CM	249	PRESBYTERIAN, TUBING CLAMP, 18.0 CM	91
PAYR INT.CRUSHING CLAMP W.PIN 29.0 CM	249	PRICE-THOMAS FORCEPS 22,0 CM	117
PAYR INT.CRUSHING CLAMP W/O PIN 29.0 CM	249	PRICE-THOMAS FORCEPS 22,0 CM	118
PAYR INT.CRUSHING CLAMP W/O PIN 21.0 CM	249	PRICE-THOMAS FORCEPS 22,0 CM	118
PAYR LIGATURE CONDUCTOR CVD. 22.0 CM	152	PRINCE TONSIL SCISSORS CVD 17.5 CM	36
PAYR LIGATURE CONDUCTOR STR 22.0 CM	152	PROBE + DIRECTOR 11.5 CM 1 MM	214
PAYR-BABY INT.CRUSHING CLAMP 15.0 CM	249	PROBE + DIRECTOR 11.5 CM 2 MM	214
PAYR-BABY INT.CRUSHING CLAMP 15.0 CM	249	PROBE + DIRECTOR 13.0 CM 1 MM	214
PEAN ARTERY FORCEPS STRAIGHT 14.0 CM	99	PROBE + DIRECTOR 13.0 CM 2 MM	214
PEAN ARTERY FORCEPS STRAIGHT 16.0 CM	99	PROBE + DIRECTOR 14.5 CM 1 MM	214
PEAN-DELICATE ART.FCPS.CVD 13.0 CM	105	PROBE + DIRECTOR 14.5 CM 2 MM	214
PEAN-DELICATE ART.FCPS.CVD 16.0 CM	105	PROBE + DIRECTOR 16.0 CM 1 MM	214
PEAN-DELICATE ART.FCPS.STR 13.0 CM	105	PROBE + DIRECTOR 16.0 CM 2 MM	214
PEAN-DELICATE ART.FCPS.STR 16.0 CM	105	PROBE + DIRECTOR 18.0 CM 1 MM	214
PEAN-DELICATE FCPS.CVD 14.0 CM	105	PROBE + DIRECTOR 18.0 CM 2 MM	214
PEAN-DELICATE FCPS.STR 14.0 CM	105	PROBE + DIRECTOR 20.0 CM 1 MM	214
PEDERSON VAGINAL SPECULUM 100X22 MM	260	PROBE + DIRECTOR 20.0 CM 2 MM	214
PEDERSON VAGINAL SPECULUM 120X25 MM	260	PROBE W.EYE 11.5 CM 2 MM	214
PEDERSON VAGINAL SPECULUM 75X13 MM	260	PROBE W.EYE 13.0 CM 2 MM	214
PEERS TOWEL FORCEPS 14,5 CM	88	PROBE W.EYE 14.5 CM 2 MM	214
PELKMANN DRESSING FORCEPS CVD 25.0 CM	89	PROBE W.EYE 16.0 CM 2 MM	214
PELKMANN DRESSING FORCEPS STR 25.0 CM	89	PROBE W.EYE 18.0 CM 2 MM	214
PENNINGTON FORCEPS 15,5 CM	97	PROBE W.EYE 20.0 CM 2 MM	214
PENNINGTON FORCEPS 20.0 CM	97	PYE-SMITH (HARRISON), STERILIZING FORCEPS, 35.0 CM	308
PESTALOZZA, OVUM CURETTE, 30,0 CM	291	QUINKE, LUMBAR PUNCTURE NEEDLE, Ø 0,7 X 50 MM	226
PHANEUF FCPS.CVD 1X2 T 21.5 CM	119	QUINKE, LUMBAR PUNCTURE NEEDLE, Ø 0,7 X 76 MM	226
PHANEUF FCPS.STR 1X2 T 21.5 CM	119	QUINKE, LUMBAR PUNCTURE NEEDLE, Ø 0,7 X 89 MM	226
PIERCE ANTRUM TROCAR W.TUB.CONN. 3.0 MM	220	QUINKE, LUMBAR PUNCTURE NEEDLE, Ø 1,0 X 76 MM	226
PIERCE ANTRUM TROCAR W.TUB.CONN. 4.0 MM	220	QUINKE, LUMBAR PUNCTURE NEEDLE, Ø 1,0 X 89 MM	226
PIERCE ANTRUM TROCAR W.TUB.CONN. 5.0 MM	220	QUINKE, LUMBAR PUNCTURE NEEDLE, Ø 1,2 X 76 MM	226
PIFFARD, LUPUS CURETTE, Ø 3 MM, 14,0 CM	294	QUINKE, LUMBAR PUNCTURE NEEDLE, Ø 1,2 X 89 MM	226
PIFFARD, LUPUS CURETTE, Ø 4 MM, 14,0 CM	294	RADOLF NAIL FORCEPS 13,5CM	296
PIFFARD, LUPUS CURETTE, Ø 5 MM, 14,0 CM	294	RAGNELL, RETRACTOR DOUBLE-ENDED, 8x3/ 16x5 MM, 15,0 CM	163
PIPER, OBSTETRICAL FORCEPS, 44.0 CM	290	RAGNELL-DAVIS RETRACTOR 14.0 CM	163
PLASTER-OF-PARIS SHEARS 20.0 CM	45	RAMPLEY SPONGE HOLDING FORCEPS 18.0 CM	90
PLESTER, RETRACTOR LEFT 11.0 CM	192	RAMPLEY SPONGE HOLDING FORCEPS 25.0 CM	90
PLESTER, RETRACTOR RIGHT 11.0 CM	192	RAMSEY, DRESSING FORCEPS, 18.0 CM	68
PLESTER, SELF-RETAINING RETRACTOR, 2x2 PRONGS, BLUNT, 13.0 CM	192	RAMSEY, TISSUE FCPS., 1X2 TEETH, 18.0 CM	76
PLESTER, SELF-RETAINING RETRACTOR, 2x2 PRONGS, SHARP, 13.0 CM	192	RAMSEY, TISSUE FCPS., 2X3 TEETH, 18.0 CM	76
POOLE SUCTION TUBE CURVED, Ø 6 MM, 22.0 CM	221	RANDALL KIDNEY STONE FCPS FIG.1 23.0 CM	232
POOLE SUCTION TUBE CURVED, Ø 8 MM, 22.0 CM	221	RANDALL KIDNEY STONE FCPS FIG.2 22.0 CM	232
POOLE, SUCTION TUBE, STRAIGHT, Ø 10,0 MM, 22.0CM	221	RANDALL KIDNEY STONE FCPS FIG.3 22.0 CM	232
POOLE, SUCTION TUBE, STRAIGHT, Ø 6,0 MM, 22.0 CM	221	RANDALL KIDNEY STONE FCPS FIG.4 22.0 CM	232
POPEN (FERGUSON), SUCTION TUBE Ø 2.0 MM, 14.0 CM, LUER ATTACHMENT	223	RANDALL KIDNEY STONE FCPS.FIG.5 19,0 CM	232
POPEN (FERGUSON), SUCTION TUBE Ø 2.7 MM, 14.0 CM, LUER ATTACHMENT	223	RANDALL KIDNEY STONE FCPS.FIG.6 19,0 CM	232
POPEN (FERGUSON), SUCTION TUBE Ø 3.3. MM, 14.0 CM, LUER ATTACHMENT	223	RANDALL, SUCTION BIOPSY CURETTE Ø 4.0 MM, 24.0 CM	278
POPEN (FERGUSON), SUCTION TUBE Ø 4.0 MM, 14.0 CM, LUER ATTACHMENT	223	RECAMIER, UTERINE CURETTE, BLUNT, MALLEABLE, FIG. 0, Ø 6 MM, 31,0 CM	283
POTTS DE MARTEL, VASCULAR SCS. TC, 24.0 CM	53	RECAMIER, UTERINE CURETTE, BLUNT, MALLEABLE, FIG. 00, Ø 5 MM, 31,0 CM	283
POTTS, VASCULAR SCS., SUPERCUT, 25°, SH/SH, 19,0 CM	58	RECAMIER, UTERINE CURETTE, BLUNT, MALLEABLE, FIG. 1, Ø 7 MM, 31,0 CM	283
POTTS, VASCULAR SCS., SUPERCUT, 45°, SH/SH, 19,0 CM	58	RECAMIER, UTERINE CURETTE, BLUNT, MALLEABLE, FIG. 10, Ø 20 MM, 31,0 CM	283
POTTS, VASCULAR SCS., SUPERCUT, 60°, SH/SH, 19,0 CM	58	RECAMIER, UTERINE CURETTE, BLUNT, MALLEABLE, FIG. 2, Ø 8 MM, 31,0 CM	283
POTTS-DE MARTEL, VASCULAR SCISSORS 60°, 21,0 CM	37	RECAMIER, UTERINE CURETTE, BLUNT, MALLEABLE, FIG. 3, Ø 9 MM, 31,0 CM	283
POTTS-DE MARTEL, VASCULAR SCISSORS, 60°, 24,0 CM	37	RECAMIER, UTERINE CURETTE, BLUNT, MALLEABLE, FIG. 4, Ø 11 MM, 31,0 CM	283
POTTS-SMITH, TISSUE FORCEPS, STRAIGHT, 1 X 2 TEETH, 18,0 CM	74	RECAMIER, UTERINE CURETTE, BLUNT, MALLEABLE, FIG. 5, Ø 12 MM, 31,0 CM	283
POTTS-SMITH, DISSECTING SCISSORS, 19,0 CM	42	RECAMIER, UTERINE CURETTE, BLUNT, MALLEABLE, FIG. 6, Ø 14 MM, 31,0 CM	283
POTTS-SMITH, DRESSING FCPS., TC, 15,0 CM	83	RECAMIER, UTERINE CURETTE, BLUNT, MALLEABLE, FIG. 7, Ø 15 MM, 31,0 CM	283
POTTS-SMITH, DRESSING FCPS., TC, 18,0 CM	83	RECAMIER, UTERINE CURETTE, BLUNT, MALLEABLE, FIG. 8, Ø 16 MM, 31,0 CM	283
POTTS-SMITH, DRESSING FCPS., TC, 20,0 CM	83	RECAMIER, UTERINE CURETTE, BLUNT, MALLEABLE, FIG. 9, Ø 19 MM, 31,0 CM	283
POTTS-SMITH, DRESSING FORCEPS, CURVED, 18,0 CM	67	RECAMIER, UTERINE CURETTE, BLUNT, RIGID, FIG. 0, Ø 6 MM, 31,0 CM	283
POTTS-SMITH, DRESSING FORCEPS, CURVED, 21,0 CM	67	RECAMIER, UTERINE CURETTE, BLUNT, RIGID, FIG. 00, Ø 5 MM, 31,0 CM	283
POTTS-SMITH, DRESSING FORCEPS, CURVED, 25,0 CM	67	RECAMIER, UTERINE CURETTE, BLUNT, RIGID, FIG. 3, Ø 19 MM, 31,0 CM	283
POTTS-SMITH, DRESSING FORCEPS, STRAIGHT, 18,0 CM	67	RECAMIER, UTERINE CURETTE, BLUNT, RIGID, FIG. 10, Ø 20 MM, 31,0 CM	283
POTTS-SMITH, DRESSING FORCEPS, STRAIGHT, 21,0 CM	67	RECAMIER, UTERINE CURETTE, BLUNT, RIGID, FIG. 2, Ø 8 MM, 31,0 CM	283
POTTS-SMITH, DRESSING FORCEPS, STRAIGHT, 25,0 CM	67	RECAMIER, UTERINE CURETTE, BLUNT, RIGID, FIG. 3, Ø 9 MM, 31,0 CM	283
POTTS-SMITH, TISSUE FORCEPS, CURVED, 1 X 2 TEEHT, 25,0 CM	74	RECAMIER, UTERINE CURETTE, BLUNT, RIGID, FIG. 4, Ø 11 MM, 31,0 CM	283
POTTS-SMITH, TISSUE FORCEPS, CURVED, 1 X 2 TEETH, 18,0 CM	74	RECAMIER, UTERINE CURETTE, BLUNT, RIGID, FIG. 5, Ø 12 MM, 31,0 CM	283
POTTS-SMITH, TISSUE FORCEPS, CURVED, 1 X 2 TEETH, 21,0 CM	74	RECAMIER, UTERINE CURETTE, BLUNT, RIGID, FIG. 6, Ø 14 MM, 31,0 CM	283
POTTS-SMITH, TISSUE FORCEPS, STRAIGHT, 1 X 2 TEETH, 21,0 CM	74	RECAMIER, UTERINE CURETTE, BLUNT, RIGID, FIG. 7, Ø 15 MM, 31,0 CM	283
POTTS-SMITH, TISSUE FORCEPS, STRAIGHT, 1 X 2 TEETH, 25,0 CM	74	RECAMIER, UTERINE CURETTE, BLUNT, RIGID, FIG. 8, Ø 16 MM, 31,0 CM	283
POTTS-SMITH, VASCULAR SCISSORS 25° ANGLED, WITH TC-INSERTS, 19,0 CM	54	RECAMIER, UTERINE CURETTE, BLUNT, RIGID, FIG. 9, Ø 19 MM, 31,0 CM	283
POTTS-SMITH, VASCULAR SCISSORS, 40° ANGLED, WITH TC-INSERTS, 19,0 CM	54	RECAMIER, UTERINE CURETTE, SHARP, MALLEABLE, FIG. 0, Ø 6 MM, 31,0 CM	282
POTTS-SMITH, VASCULAR SCISSORS, 55° BEND, 18,0 CM	37	RECAMIER, UTERINE CURETTE, SHARP, MALLEABLE, FIG. 0, Ø 6 MM, 26,0 CM	280
POTTS-SMITH, VASCULAR SCISSORS, 60° ANGLED, WITH TC-INSERTS, 19,0 CM	54	RECAMIER, UTERINE CURETTE, SHARP, MALLEABLE, FIG. 00, Ø 5 MM, 31,0 CM	282
POZZI, UTERINE TENACULUM FORCEPS, STRONG PAT., 25,0CM	273	RECAMIER, UTERINE CURETTE, SHARP, MALLEABLE, FIG. 00, Ø 5 MM, 31,0 CM	280
PRATT FISTULA HOOK 21,0 CM FIG.1	256	RECAMIER, UTERINE CURETTE, SHARP, MALLEABLE, FIG. 1, Ø 7 MM, 31,0 CM	282

Inhaltsverzeichnis  
Index

RECAMIER, UTERINE CURETTE, SHARP, MALLEABLE, FIG. 1, Ø7 MM, 26,0 CM	280	RIBBON, ABDOMINAL SPATULA, 330x25 MM, MALLEABLE	210
RECAMIER, UTERINE CURETTE, SHARP, MALLEABLE, FIG. 10, Ø 20 MM, 31,0 CM	282	RIBBON, ABDOMINAL SPATULA, 330X32 MM, MALLEABLE	210
RECAMIER, UTERINE CURETTE, SHARP, MALLEABLE, FIG. 2, Ø 8 MM, 31,0 CM	282	RIBBON, ABDOMINAL SPATULA, 330X40 MM, MALLEABLE	210
RECAMIER, UTERINE CURETTE, SHARP, MALLEABLE, FIG. 2, Ø8 MM, 26,0 CM	280	RIBBON, ABDOMINAL SPATULA, 330X50 MM, MALLEABLE	210
RECAMIER, UTERINE CURETTE, SHARP, MALLEABLE, FIG. 3, Ø 9 MM, 31,0 CM	282	RICARD ABDOMINAL RETRACTOR 280 MM OPEN.	198
RECAMIER, UTERINE CURETTE, SHARP, MALLEABLE, FIG. 3, Ø9 MM, 26,0 CM	280	RICARD ABDOMINAL RETRACTOR 300MM OPENING	198
RECAMIER, UTERINE CURETTE, SHARP, MALLEABLE, FIG. 4, Ø 11 MM, 31,0 CM	282	RICARD, ABDOMINAL RETRACTOR, MIDDLE VALVE ONLY, 55X70 MM	200
RECAMIER, UTERINE CURETTE, SHARP, MALLEABLE, FIG. 4, Ø11 MM, 26,0 CM	280	RICARD, ABDOMINAL RETRACTOR, MIDDLE VALVE ONLY, 65X50 MM	200
RECAMIER, UTERINE CURETTE, SHARP, MALLEABLE, FIG. 5, Ø 12 MM, 31,0 CM	282	RICARD, ABDOMINAL RETRACTOR, MIDDLE VALVE ONLY, 90X80 MM	200
RECAMIER, UTERINE CURETTE, SHARP, MALLEABLE, FIG. 5, Ø12 MM, 26,0 CM	280	RICHARDSON-EASTMAN RETRACTOR FIG.1 26 CM	178
RECAMIER, UTERINE CURETTE, SHARP, MALLEABLE, FIG. 6, Ø 14 MM, 31,0 CM	282	RICHARDSON-EASTMAN RETRACTOR FIG.1+2	178
RECAMIER, UTERINE CURETTE, SHARP, MALLEABLE, FIG. 6, Ø14 MM, 26,0 CM	280	RICHARDSON-EASTMAN RETRACTOR FIG.2 28 CM	178
RECAMIER, UTERINE CURETTE, SHARP, MALLEABLE, FIG. 7, Ø 15 MM, 31,0 CM	282	RICHTER OPERATING SCISS. BL/BL 14.5 CM	32
RECAMIER, UTERINE CURETTE, SHARP, MALLEABLE, FIG. 8, Ø 16 MM, 31,0 CM	282	RICHTER RETRACTOR 16.0 CM	196
RECAMIER, UTERINE CURETTE, SHARP, MALLEABLE, FIG. 9, Ø 19 MM, 31,0 CM	282	RICHTER-HEATH CLIP FORCEPS 14.0 CM	154
RECAMIER, UTERINE CURETTE, SHARP, RIGID, FIG. 0, Ø 6 MM, 31,0 CM	282	ROBERTS ARTERY FORCEPS CURVED 22,0 CM	107
RECAMIER, UTERINE CURETTE, SHARP, RIGID, FIG. 00, Ø 5 MM, 31,0 CM	282	ROBERTS ARTERY FORCEPS STRAIGHT 22,0 CM	107
RECAMIER, UTERINE CURETTE, SHARP, RIGID, FIG. 1, Ø 7 MM, 31,0 CM	282	ROBIN-MASSÉ ABDOMINAL RETRACTOR	199
RECAMIER, UTERINE CURETTE, SHARP, RIGID, FIG. 10, Ø 20 MM, 31,0 CM	282	ROBIN-MASSÉ, ABDOMINAL RETRACTOR, VALVE ONLY, 40X64 MM	200
RECAMIER, UTERINE CURETTE, SHARP, RIGID, FIG. 2, Ø 8 MM, 31,0 CM	282	ROBIN-MASSÉ, ABDOMINAL RETRACTOR, VALVE ONLY, 55X65 MM	200
RECAMIER, UTERINE CURETTE, SHARP, RIGID, FIG. 3, Ø 9 MM, 31,0 CM	282	ROBIN-MASSÉ, ABDOMINAL RETRACTOR, VALVE ONLY, 55X75 MM	200
RECAMIER, UTERINE CURETTE, SHARP, RIGID, FIG. 4, Ø 11 MM, 31,0 CM	282	ROCHARD, ABDOMINAL RETRACTOR, 105X48 MM	209
RECAMIER, UTERINE CURETTE, SHARP, RIGID, FIG. 5, Ø 12 MM, 31,0 CM	282	ROCHARD, ABDOMINAL RETRACTOR, 115X48 MM	209
RECAMIER, UTERINE CURETTE, SHARP, RIGID, FIG. 6, Ø 14 MM, 31,0 CM	282	ROCHARD, ABDOMINAL RETRACTOR, 125X48 MM	209
RECAMIER, UTERINE CURETTE, SHARP, RIGID, FIG. 7, Ø 15 MM, 31,0 CM	282	ROCHARD, ABDOMINAL RETRACTOR, 155X48 MM	209
RECAMIER, UTERINE CURETTE, SHARP, RIGID, FIG. 8, Ø 16 MM, 31,0 CM	282	ROCHARD, ABDOMINAL RETRACTOR, 95X48 MM	209
RECAMIER, UTERINE CURETTE, SHARP, RIGID, FIG. 9, Ø 19 MM, 31,0 CM	282	ROCHARD, FIXATION DEVICE FOR ABDOMINAL RETRACTOR	209
RECAMIER, UTERINE CURETTE, SHARP, RIGID FIG. 11, Ø 21 MM, 26,0 CM	280	ROCHARD, MOUNTING FRAME WITH 1 ARM	209
RECAMIER, UTERINE CURETTE, SHARP, RIGID FIG. 12, Ø 23 MM, 26,0 CM	280	ROCHARD, MOUNTING FRAME WITH 2 ARMS	209
RECAMIER, UTERINE CURETTE, SHARP, RIGID, FIG. 0, Ø6 MM, 26,0 CM	280	ROCHESTER-CARMALT FCPS CVD 16.0 CM	105
RECAMIER, UTERINE CURETTE, SHARP, RIGID, FIG. 00, Ø5 MM, 26,0 CM	280	ROCHESTER-CARMALT FCPS CVD 20.0 CM	105
RECAMIER, UTERINE CURETTE, SHARP, RIGID, FIG. 1, Ø7 MM, 26,0 CM	280	ROCHESTER-CARMALT FCPS STR 16.0 CM	105
RECAMIER, UTERINE CURETTE, SHARP, RIGID, FIG. 10, Ø 20 MM, 26,0 CM	280	ROCHESTER-CARMALT FCPS STR 20.0 CM	105
RECAMIER, UTERINE CURETTE, SHARP, RIGID, FIG. 2, Ø8 MM, 26,0 CM	280	ROCHESTER-PEAN ARTERY FCPS CVD 26.0 CM	106
RECAMIER, UTERINE CURETTE, SHARP, RIGID, FIG. 3, Ø9 MM, 26,0 CM	280	ROCHESTER-PEAN ARTERY FCPS STR 16.0 CM	106
RECAMIER, UTERINE CURETTE, SHARP, RIGID, FIG. 4, Ø11 MM, 26,0 CM	280	ROCHESTER-PEAN ARTERY FCPS STR 18.0 CM	106
RECAMIER, UTERINE CURETTE, SHARP, RIGID, FIG. 5, Ø12 MM, 26,0 CM	280	ROCHESTER-PEAN ARTERY FCPS STR 20.0 CM	106
RECAMIER, UTERINE CURETTE, SHARP, RIGID, FIG. 6, Ø14 MM, 26,0 CM	280	ROCHESTER-PEAN ARTERY FCPS STR 24.0 CM	106
RECAMIER, UTERINE CURETTE, SHARP, RIGID, FIG. 7, Ø15 MM, 26,0 CM	280	ROCHESTER-PEAN ARTERY FCPS STR 26.0 CM	106
RECAMIER, UTERINE CURETTE, SHARP, RIGID, FIG. 8, Ø16 MM, 26,0 CM	280	ROCHESTER-PEAN ARTERY FCPS STR 30.0 CM	106
RECAMIER, UTERINE CURETTE, SHARP, RIGID, FIG. 9, Ø19 MM, 26,0 CM	280	ROCHESTER-PEAN FCPS CVD 14.0 CM	106
RECTAL, RECTAL SCS., CURVED, BL/BL, 32.5 CM	42	ROCHESTER-PEAN FCPS CVD 16.0 CM	106
RETRACTOR BLUNT 1 PRONG 16.0 CM	160	ROCHESTER-PEAN FCPS CVD 18.0 CM	106
RETRACTOR BLUNT 2 PRONGS 16.0 CM	160	ROCHESTER-PEAN FCPS CVD 20.0 CM	106
RETRACTOR BLUNT 3 PRONGS 16.0 CM	160	ROCHESTER-PEAN FCPS CVD 22.0 CM	106
RETRACTOR BLUNT 4 PRONGS 16.0 CM	160	ROCHESTER-PEAN FCPS CVD 24.0 CM	106
RETRACTOR BLUNT FLEX 3 PRONGS 16.0 CM	160	ROCHESTER-PEAN FCPS CVD 30.0 CM	106
RETRACTOR BLUNT FLEX 4 PRONGS 16.0 CM	160	ROCHESTER-PEAN FCPS STR 14.0 CM	106
RETRACTOR BLUNT FLEX.2 PRONGS 16.0 CM	160	ROCHESTER-PEAN FCPS STR 22.0 CM	106
RETRACTOR SEMI-SHARP 1 PRONG 16.0 CM	160	ROEDER TOWEL FORCEPS 13.0 CM	86
RETRACTOR SEMI-SHARP 2 PRONGS 16.0 CM	160	ROEDER TOWEL FORCEPS 15.0 CM	87
RETRACTOR SEMI-SHARP 3 PRONGS 16.0 CM	160	ROGGE STERILIZING FORCEPS 23,0 CM	308
RETRACTOR SEMI-SHARP 4 PRONGS 16.0 CM	160	ROUX RETRACTOR FIG.1	167
RETRACTOR SHARP 1 PRONG 16.0 CM	160	ROUX RETRACTOR FIG.2	167
RETRACTOR SHARP 2 PRONGS 16.0 CM	160	ROUX RETRACTOR FIG.3	167
RETRACTOR SHARP 3 PRONGS 16.0 CM	160	ROUX RETRACTOR SET FIG.1-3	167
RETRACTOR SHARP 4 PRONGS 16.0 CM	160	ROUX, RETRACTOR, FIG.4	167
RETRACTOR SHARP FLEX. 2 PRONGS 16.0 CM	160	RUDD HAEMORRHOIDAL LIGATORS	255
RETRACTOR SHARP FLEX. 3 PRONGS 16.0 CM	160	RUMEL DISS.FORCEPS FIG.4, 23.0 CM	109
RETRACTOR SHARP FLEX. 4 PRONGS 16.0 CM	160	RUMEL FORCEPS FIG.1, 23.0 CM	109
RETRACTOR, 2 PRONG, 14x8 MM, BLUNT, 16,0 CM	162	RUMEL FORCEPS FIG.2, 23.0 CM	109
REVERDIN NEEDLE FIG.1 14.0 CM	145	RUMEL FORCEPS FIG.3, 23.0 CM	109
REVERDIN NEEDLE FIG.1 19.5 CM	145	RUSS.MODEL TISSUE FCPS 15.0 CM	74
REVERDIN NEEDLE FIG.1 22.5 CM	145	RUSS.MODEL TISSUE FCPS 20.0 CM	74
REVERDIN NEEDLE FIG.2 14.0 CM	145	RUSS.MODEL TISSUE FORCEPS 25.0 CM	74
REVERDIN NEEDLE FIG.2 19.5 CM	145	RYDER/FRENCH-EYE NEEDLE HOLDER TC 13 CM	137
REVERDIN NEEDLE FIG.2 22.5 CM	145	RYDER/FRENCH-EYE NEEDLE HOLDER TC 15 CM	137
REVERDIN NEEDLE FIG.3 14.0 CM	145	RYDER/FRENCH-EYE NEEDLE HOLDER TC 18 CM	137
REVERDIN NEEDLE FIG.3 19.5 CM	145	RYDER/FRENCH-EYE NEEDLE HOLDER TC 20 CM	137
REVERDIN NEEDLE FIG.3 22.5 CM	145	RYDER/FRENCH-EYE NEEDLE HOLDER TC 23 CM	137
REVERDIN NEEDLE FIG.4 14.0 CM	145	RYDER/FRENCH-EYE NEEDLE HOLDER TC 26 CM	137
REVERDIN NEEDLE FIG.4 19.5 CM	145	SAALFELD, COMEDO EXTRACTOR, 10,0 CM	295
REVERDIN NEEDLE FIG.4 22.5 CM	145	SAALFELD, COMEDO EXTRACTOR, 14,0 CM	295
REVERDIN, ABDOMINAL SPATULA, 280 x 45/60 MM	210	SAENGER OVUM FORCEPS, CURVED, 27.0CM	291
REYNOLDS DISS.SCISSORS CVD SHARP 18.0 CM	26	SANVENERO SCISSORS CVD SH/SH 14.0 CM	27
REYNOLDS DISS.SCISSORS CVD SHARP 20.0 CM	26	SANVENERO SCISSORS STR SH/SH 14.0 CM	27
REYNOLDS DISS.SCISSORS CVD SHARP 23.0 CM	26	SAROT ARTERY FORCEPS CVD 24.0 CM	107
REYNOLDS DISS.SCISSORS STR SHARP 15.0 CM	26	SAROT ARTERY FORCEPS STR 24.0 CM	107
REYNOLDS DISS.SCISSORS STR SHARP 18.0 CM	26	SAROT NEEDLE HOLDER TC 18.0 CM	134
REYNOLDS DISSECTING SCISSORS, CURVED, 15,0 CM	26	SAROT NEEDLE HOLDER TC 26.0 CM	134
REYNOLDS, DISSEC.-SCS. TC, CURVED,16.0CM	51	SAROT, NEEDLE HOLDER WITH TC, 20,0 CM	134
REYNOLDS, DISSEC.-SCS. TC, STRAIGHT, 15,0 CM	51	SATINSKY ARTERY SCISSORS S-SHAPED 24.5CM	39
REYNOLDS, DISSEC.-SCS., SUPERCUT, STRAIGHT, BL/BL, 12,5 CM	57	SAUERBRUCH RETRACTOR 44X16 MM 22.5 CM	176
REYNOLDS, DISSECTING SCISSORS, POINTED, CURVED, 25,0 CM	26	SAUERBRUCH RETRACTOR 55X22 MM 22.5 CM	176
RIBBON, ABDOMINAL SPATULA, 200 x 12 MM, MALLEABLE	210	SAUERBRUCH RETRACTOR 72X19 MM 22.5 CM	176
RIBBON, ABDOMINAL SPATULA, 200 x 17 MM, MALLEABLE	210	SAW BLADE ONLY FOR KA 910/17, 20MM	296
RIBBON, ABDOMINAL SPATULA, 200 x 20 MM, MALLEABLE	210	SAW BLADE ONLY, FOR 186-420-17, Ø 30 MM	296
RIBBON, ABDOMINAL SPATULA, 200 x 25 MM, MALLEABLE	210	SCALP-CONTOUR RETRACTOR BLUNT 14.0 CM	189
RIBBON, ABDOMINAL SPATULA, 200 x 6 MM, MALLEABLE	210	SCALP-CONTOUR RETRACTOR SHARP 14.0 CM	189
RIBBON, ABDOMINAL SPATULA, 330x13 MM, MALLEABLE	210	SCALPEL HANDLE NO.3	2

SCALPEL HANDLE NO.3 L CHR.	2	SIMPSON-BRAUN, OBSTETRICAL FORCEPS, 33,0 CM	289
SCALPEL HANDLE NO.4	3	SIMPSON-BRAUN, OBSTETRICAL FORCEPS, 36,0 CM	289
SCALPEL HANDLE NO.4 L	3	SIMPSON-LUIKART, OBSTETRICAL FORCEPS, 36,0 CM,	289
SCALPEL HANDLE NO.7	2	SIMS GYNEC. SCISSORS CVD BL/BL 23.0 CM	40
SCALPEL HANDLE NO.7K	2	SIMS GYNEC. SCISSORS CVD SH/BL 20.0 CM	40
SCALPEL HANDLE, HOLLOW, NO.8	3	SIMS GYNEC. SCISSORS CVD SH/BL 23.0 CM	40
SCALPEL HANDLE, HOLLOW, NO.9	3	SIMS GYNEC. SCISSORS CVD SH/SH 23.0 CM	40
SCALPEL HANDLE, NO.3 WITH SCALE	2	SIMS GYNEC. SCISSORS STR BL/BL 20.0 CM	39
SCHAEDEL TOWEL FORCEPS 9,0 CM	86	SIMS GYNEC. SCISSORS STR BL/BL 23.0 CM	39
SCHAMBERG, COMEDO EXTRACTOR, 10,0 CM	295	SIMS GYNEC. SCISSORS STR BL/BL 23.0 CM	39
SCHEDE, BONE CURETTE, FIG.0, 17,0 CM	298	SIMS GYNEC. SCISSORS STR SH/BL 20.0 CM	39
SCHEDE, BONE CURETTE, FIG.00, 17,0 CM	298	SIMS GYNEC. SCISSORS STR SH/BL 23.0 CM	39
SCHEDE, BONE CURETTE, FIG.000, 17,0 CM	298	SIMS GYNEC. SCISSORS STR SH/SH 20.0 CM	39
SCHEDE, BONE CURETTE, FIG.1, 17,0 CM	298	SIMS RECTAL SPECULA FENESTRATED 15,0 CM	252
SCHEDE, BONE CURETTE, FIG.2, 17,0 CM	298	SIMS RECTAL SPECULA FULL BLADES 15,0 CM	252
SCHEDE, BONE CURETTE, FIG.3, 17,0 CM	298	SIMS SCISSORS CVD BL/BL 20.0 CM	40
SCHEDE, BONE CURETTE, FIG.4, 17,0 CM	298	SIMS SCISSORS CVD SH/SH 20.0 CM	40
SCHERBAK VAGINAL SPECULA BLADE ONLY, FIG. 1, 80 X 30 MM	261	SIMS UTERINE PROBE MALLEABLECM*32.0 CM*	277
SCHERBAK VAGINAL SPECULA,SET COMPLETE	261	SIMS UTERINE PROBE RIGID CM 32.0 CM	277
SCHERBAK, VAGINAL SPECULA WEIGHT ONLY, 800G	261	SIMS VAG.SPECULUM DOUBLE 60X25+30 MM	267
SCHERBAK, VAGINAL SPECULA BLADE ONLY, FIG. 2, 85 X 35 MM	261	SIMS VAG.SPECULUM DOUBLE 70X30+35 MM	267
SCHERBAK, VAGINAL SPECULA BLADE ONLY, FIG. 3, 90 X 40 MM	261	SIMS VAG.SPECULUM DOUBLE 80X35+40 MM	267
SCHERBAK, VAGINAL SPECULA BLADE ONLY, FIG. 4, 40/60X55 MM	261	SIMS, GYN.- SCISSORS TC, STRAIGHT, BL/BL, 23.0 CM	52
SCHERBAK, VAGINAL SPECULA BLADE ONLY, FIG. 5, 45/70 X 70 MM	261	SIMS, GYN.- SCISSORS TC, STRAIGHT, BL/BL, 20.0 CM	52
SCHERBAK, VAGINAL SPECULA HANDLE ONLY	261	SIMS, GYN.-SCISSORS TC, CURVED, BL/BL, 20.0 CM	52
SCHERBAK, VAGINAL SPECULA, WEIGHT ONLY, 400G	261	SIMS, GYN.-SCISSORS TC, CURVED, BL/BL, 23.0 CM	52
SCHINK, DERMATOME, SPARE BLADES ONLY	11	SIMS, GYN.-SCISSORS TC, CURVED, SH/BL, 20.0 CM	52
SCHINK, DERMATOME, 30.0 CM	11	SIMS, GYN.-SCISSORS TC, CURVED, SH/BL, 23.0 CM	52
SCHINK, DERMATOMES, SKIN STRAIGHTENING PLATE ONLY	10	SIMS, GYN.-SCISSORS TC, CURVED, SH/SH, 20.0 CM	52
SCHMID NEEDLE 15,0 CM 3MM	224	SIMS, GYN.-SCISSORS TC, CURVED, SH/SH, 23.0 CM	52
SCHMID NEEDLE 15,0 CM 4 MM	224	SIMS, GYN.-SCISSORS TC, STRAIGHT, SH/BL, 20.0 CM	52
SCHMID NEEDLE 15,0 CM 5 MM	224	SIMS, GYN.-SCISSORS TC, STRAIGHT, SH/BL, 23.0 CM	52
SCHMID NEEDLE 15,0 CM 6 MM	224	SIMS, GYN.-SCISSORS TC, STRAIGHT, SH/SH, 20.0 CM	52
SCHMIEDEN LIGATURE CONDUCTOR 19,0 CM	152	SIMS, GYN.-SCISSORS TC, STRAIGHT, SH/SH, 23.0 CM	52
SCHMIEDEN LIGATURE NEEDLE 21.0 CM	148	SIMS, UTERINE CURETTE, BLUNT, MALLEABLE, FIG. 0, Ø 6 MM, 26,0 CM	281
SCHMIEDEN-PAYR LIGATURE CONDUCTOR 19,0CM	152	SIMS, UTERINE CURETTE, BLUNT, MALLEABLE, FIG. 00, Ø 5 MM, 26,0 CM	281
SCHMIEDEN-TAYLOR DURA SCISSORS 17.0 CM	35	SIMS, UTERINE CURETTE, BLUNT, MALLEABLE, FIG. 1, Ø 7 MM, 26,0 CM	281
SCHROEDER FCPS CVD 24.0 CM, 2X2	274	SIMS, UTERINE CURETTE, BLUNT, MALLEABLE, FIG. 10, Ø 20 MM, 26,0 CM	281
SCHROEDER FORCEPS BOX LOCK, 25,0 CM	273	SIMS, UTERINE CURETTE, BLUNT, MALLEABLE, FIG. 2, Ø 8 MM, 26,0 CM	281
SCHROEDER VULSELLUM FCPS STR 2X2T 24.0CM	274	SIMS, UTERINE CURETTE, BLUNT, MALLEABLE, FIG. 3, Ø 9 MM, 26,0 CM	281
SCHUBERT, CERV.BIOPSY+SPEC.FCPS 26.0 CM	287	SIMS, UTERINE CURETTE, BLUNT, MALLEABLE, FIG. 4, Ø 11 MM, 26,0 CM	281
SCHUBERT, CERVICAL BIOPSY FORCEPS, 21.0 CM	286	SIMS, UTERINE CURETTE, BLUNT, MALLEABLE, FIG. 5, Ø 12 MM, 26,0 CM	281
SCHUBERT, CERVICAL BIOPSY FORCEPS, 29 CM	286	SIMS, UTERINE CURETTE, BLUNT, MALLEABLE, FIG. 6, Ø 14 MM, 26,0 CM	281
SCHUMACHER CERVICAL BIOPSY+SPEC.FCPS 5MM	287	SIMS, UTERINE CURETTE, BLUNT, MALLEABLE, FIG. 7, Ø 15 MM, 26,0 CM	281
SCHUMACHER CERVICAL BIOPSY+SPEC.FCPS 7MM	287	SIMS, UTERINE CURETTE, BLUNT, MALLEABLE, FIG. 8, Ø 16 MM, 26,0 CM	281
SCHUMACHER UMBILICAL SCISSORS 16.0 CM	43	SIMS, UTERINE CURETTE, BLUNT, MALLEABLE, FIG. 9, Ø 19 MM, 26,0 CM	281
SCHUMACHER-VAN DOREN FCPS FIG.1	286	SIMS, UTERINE CURETTE, BLUNT, RIGID, FIG. 0, Ø 6 MM, 26,0 CM	281
SCUDDER INTEST.CLAMP FCPS. CVD. 33.0 CM	250	SIMS, UTERINE CURETTE, BLUNT, RIGID, FIG. 00, Ø 5 MM, 26,0 CM	281
SCUDDER INTEST.CLAMP FCPS. STR. 33,0 CM	250	SIMS, UTERINE CURETTE, BLUNT, RIGID, FIG. 1, Ø 7 MM, 26,0 CM	281
SEDILLOT, RASPARTORY FINGERRINGHANDLE, 15 MM, 21.0 CM	303	SIMS, UTERINE CURETTE, BLUNT, RIGID, FIG. 10, Ø 20 MM, 26,0 CM	281
SEGDOND MYOMA KNIFE, 27,0CM	279	SIMS, UTERINE CURETTE, BLUNT, RIGID, FIG. 2, Ø 8 MM, 26,0 CM	281
SELDINGER-STILLE, BIOPSY-CANNULA, Ø 1,6 x 70 MM	225	SIMS, UTERINE CURETTE, BLUNT, RIGID, FIG. 3, Ø 9 MM, 26,0 CM	281
SELDINGER-STILLE, BIOPSY-CANNULA, Ø 2,0 x 70 MM	225	SIMS, UTERINE CURETTE, BLUNT, RIGID, FIG. 4, Ø 11 MM, 26,0 CM	281
SEMB BRONCHUS CLAMPS 22.0 CM	118	SIMS, UTERINE CURETTE, BLUNT, RIGID, FIG. 5, Ø 12 MM, 26,0 CM	281
SEMB BRONCHUS CLAMPS 22,0 CM	118	SIMS, UTERINE CURETTE, BLUNT, RIGID, FIG. 6, Ø 14 MM, 26,0 CM	281
SEMKEN TISSUE FCPS STR 1X2 TEETH 12.5CM	73	SIMS, UTERINE CURETTE, BLUNT, RIGID, FIG. 7, Ø 15 MM, 26,0 CM	281
SEMKEN TISSUE FCPS STR 2X3 TEETH 12,0cm	73	SIMS, UTERINE CURETTE, BLUNT, RIGID, FIG. 8, Ø 16 MM, 26,0 CM	281
SEMKEN, DRESSING FORCEPS STRAIGHT, 12.5 CM	67	SIMS, UTERINE CURETTE, BLUNT, RIGID, FIG. 9, Ø 19 MM, 26,0 CM	281
SEMKEN, DRESSING FORCEPS STRAIGHT, 15.0 CM	67	SIMS, UTERINE CURETTE, SHARP, MALLEABLE, FIG. 10, Ø20 MM, 26,0 CM	280
SEMKEN, TISSUE FCPS, 1X2 TEETH, TC, 12,5 CM	82	SIMS, UTERINE CURETTE, SHARP, MALLEABLE, FIG. 7, Ø15 MM, 26,0 CM	280
SEMKEN, TISSUE FCPS, 1X2 TEETH, TC, 15,5 CM	82	SIMS, UTERINE CURETTE, SHARP, MALLEABLE, FIG. 8, Ø16 MM, 26,0 CM	280
SEMKEN, TISSUE FORCEPS, STRAIGHT, 1 X 2TEETH, 15.0 CM	73	SIMS, UTERINE CURETTE, SHARP, MALLEABLE, FIG. 9, Ø19 MM, 26,0 CM	280
SEMM VAGINAL SPECULA 100X17/20MM	260	SIMS, VAGINAL SPECULA, DOUBLE, 102X44 / 95X38 MM	266
SEMM VAGINAL SPECULA 100X25/30MM	260	SIMS, VAGINAL SPECULA, DOUBLE, 76X25 / 70X22 MM	266
SEMM VAGINAL SPECULA 90X14/18MM	260	SIMS, VAGINAL SPECULA, DOUBLE, 82X30 / 76X25 MM	266
SEMM, ABDOMINAL RETRACTOR, FRAME ONLY, 275X250 MM	207	SIMS, VAGINAL SPECULA, DOUBLE, 95X38 / 82X30 MM	266
SEMM, ABDOMINAL RETRACTOR, VALVE ONLY, 105X35 MM	208	SINGLEY-TUTTLE GRASPING FORCEPS 23,0 CM	68
SEMM, ABDOMINAL RETRACTOR, VALVE ONLY, 47X65 MM	208	SKENE, UTERINE TENACULUM FORCEPS, 24,0 CM	274
SEMM, ABDOMINAL RETRACTOR, VALVE ONLY, 50X54 MM	208	SMITH (MOD.USA)BANDAGE SCISSORS 16.0 CM	45
SEMM, ABDOMINAL RETRACTOR, VALVE ONLY, 76X98 MM	208	SMITH (MOD.USA)BANDAGE SCISSORS 18.0 CM	45
SEMM, ABDOMINAL RETRACTOR, VALVE ONLY, 98X52 MM	208	SMITH (MOD.USA)BANDAGE SCISSORS 20.0 CM	45
SENN-GREEN RETRACTOR 10X6 MM 15.0 CM	162	SMITH (MOD.USA)BANDAGE SCISSORS 23.0 CM	45
SENN-GREEN RETRACTOR 20X6 MM 15.0 CM	162	SMITH-BUIE ANAL RETRACTOR 75X23MM 15,0CM	252
SENN-MILLER RETRACTOR BLOUNT 16.0 CM	163	SMITH-PETERSEN GOUGE 14MM	306
SENN-MILLER RETRACTOR SHARP 16.0 CM	163	SMITH-PETERSEN GOUGE 14MM	306
SETTING FORCEPS F.BULLDOG CLAMPS 23.0 CM	94	SMITH-PETERSEN GOUGE 16MM	306
SIEBOLD GYNEC.SCS S-CURVED BL/BL 24.0 CM	40	SMITH-PETERSEN GOUGE 16MM	306
SILVER, DERMATOMES, 19.0 CM	11	SMITH-PETERSEN GOUGE 19MM	306
SILVER, DERMATOMES, SPARE BLADES ONLY	11	SMITH-PETERSEN GOUGE 19MM	306
SIMON FISTULA HOOK 2 PRONGS 22.0 CM	279	SMITH-PETERSEN GOUGE 19MM	306
SIMON UTERINE SCOOP,FIG.1,25CM	286	SMITH-PETERSEN GOUGE 25MM	306
SIMON UTERINE SCOOP,FIG.2,25CM	286	SMITH-PETERSEN GOUGE 25MM	306
SIMON UTERINE SCOOP,FIG.3,25CM	286	SMITH-PETERSEN GOUGE 9MM	306
SIMON UTERINE SCOOP,FIG.4,25CM	286	SMITH-PETERSEN GOUGE 9MM	306
SIMON UTERINE SCOOP,FIG.5,25CM	286	SMITH-PETERSEN OSTEOTOME 13MM	305
SIMON UTERINE SCOOP,FIG.6,25CM	286	SMITH-PETERSEN OSTEOTOME 13MM	305
SIMON, RETRACTOR, 115 x 22 MM, 28,0 CM	180	SMITH-PETERSEN OSTEOTOME 16MM	305
SIMON, RETRACTOR, 115 x 27 MM, 28,0 CM	180	SMITH-PETERSEN OSTEOTOME 16MM	305
SIMPSON, OBSTETRICAL FORCEPS, 30.0 CM	289	SMITH-PETERSEN OSTEOTOME 19MM	305
SIMPSON, UTERINE PROBE, MALLEABLE, 29,0 CM	277	SMITH-PETERSEN OSTEOTOME 19MM	305
		SMITH-PETERSEN OSTEOTOME 25MM	305



Inhaltsverzeichnis  
Index

SMITH-PETERSEN OSTEOTOME 25MM	305	STANDARD OPER.SCS. CVD.SH/BL 16.5 CM	14
SMITH-PETERSEN OSTEOTOME 32MM	305	STANDARD OPER.SCS. CVD.SH/BL 18.5 CM	14
SMITH-PETERSEN OSTEOTOME 32MM	305	STANDARD OPER.SCS. CVD.SH/BL 20.0 CM	14
SMITH-PETERSEN OSTEOTOME 6MM	305	STANDARD OPER.SCS. CVD.SH/SH 11.5 CM	15
SMITH-PETERSEN OSTEOTOME 6MM	305	STANDARD OPER.SCS. CVD.SH/SH 13.0 CM	15
SMITH-PETERSEN OSTEOTOME 9MM	305	STANDARD OPER.SCS. CVD.SH/SH 14.5 CM	15
SMITH-PETERSEN OSTEOTOME 9MM	305	STANDARD OPER.SCS. CVD.SH/SH 15.5 CM	15
SOLUTION BOWL 165 x 60 MM	309	STANDARD OPER.SCS. CVD.SH/SH 16.5 CM	15
SOLUTION BOWL 175 x 70 MM	309	STANDARD OPER.SCS. STR.BL/BL 20.0 CM	14
SOLUTION BOWL 220 x 80 MM	309	STANDARD OPER.SCS. STR.SH/BL 17.5 CM	14
SOLUTION BOWL 225 x 90 MM	309	STANDARD OPER.SCS. STR.SH/SH 10.5 CM	15
SOLUTION BOWL 240 x 110 MM	309	STANDARD OPER.SCS. STR.SH/SH 17.5 CM	15
SOLUTION BOWL 275 x 115 MM	309	STANDARD OPER.SCS. STR.SH/SH 18.5 CM	15
SOLUTION BOWL 290 x 125 MM	309	STANDARD OPER.SCS. STR.SH/SH 20.0 CM	15
SOLUTION BOWL 310 x 120 MM	309	STANDARD OPER.SCS. STR.BL/BL 18.5 CM	14
SOLUTION BOWL 345 x 125 MM	309	STANDARD OPER.SCS. STR.BL/BL 10.5 CM	14
SOLUTION BOWL 380 x 130 MM	309	STANDARD OPER.SCS. STR.BL/BL 13.0 CM	14
SOMER, UTERINE ELEVATING FORCEPS, 23.0 CM	276	STANDARD OPER.SCS. STR.BL/BL 14.5 CM	14
SPENCER, LIGATURE SCISSORS, 10.5 CM	33	STANDARD OPER.SCS. STR.BL/BL 15.5 CM	14
SPENCER, LIGATURE SCISSORS, 9.0 CM	33	STANDARD OPER.SCS. STR.BL/BL 16.5 CM	14
SPENCER, LIGATURE SCISSORS, 12.5 CM	33	STANDARD OPER.SCS. STR.SH/BL 10.5 CM	14
SPENCER-WELLS, ART.FCPS.CVD 13.0 CM	99	STANDARD OPER.SCS. STR.SH/BL 11.5 CM	14
SPENCER-WELLS, ART.FCPS.CVD 15.5 CM	99	STANDARD OPER.SCS. STR.SH/BL 13.0 CM	14
SPENCER-WELLS, ART.FCPS.STR 13.0 CM	99	STANDARD OPER.SCS. STR.SH/BL 14.5 CM	14
SPENCER-WELLS, ART.FCPS.STR 15.5 CM	99	STANDARD OPER.SCS. STR.SH/BL 15.5 CM	14
SPENCER-WELLS, ARTERY FCPS CVD 20.0 CM	99	STANDARD OPER.SCS. STR.SH/BL 16.5 CM	14
SPENCER-WELLS, ARTERY FCPS STR 20.0 CM	99	STANDARD OPER.SCS. STR.SH/BL 18.5 CM	14
SPENCER-WELLS, ARTERY FCPS. STR 18.0 CM	99	STANDARD OPER.SCS. STR.SH/BL 20.0 CM	14
SPENCER-WELLS, ARTERY FORCEPS CURVED, 18.0 CM	99	STANDARD OPER.SCS. STR.SH/SH 11.5 CM	15
SPLINTER FCPS CVD SERRAT 9.0 CM	77	STANDARD OPER.SCS. STR.SH/SH 13.0 CM	15
SPLINTER FCPS CVD SERRAT.10.5 CM	77	STANDARD OPER.SCS. STR.SH/SH 14.5 CM	15
SPLINTER FCPS CVD SERRAT.11.5 CM	77	STANDARD OPER.SCS. STR.SH/SH 15.5 CM	15
SPLINTER FCPS CVD SERRAT.13.0 CM	77	STANDARD OPER.SCS. STR.SH/SH 16.5 CM	15
SPLINTER FCPS CVD SERRAT.14.5 CM	77	STANDARD SCS TC CVD BL/BL 14.5 CM	46
SPLINTER FCPS CVD SERRAT.8.0 CM	77	STANDARD SCS TC CVD BL/BL 16.5 CM	46
SPLINTER FCPS WITH PIN SERRAT CVD 8.0 CM	77	STANDARD SCS TC CVD BL/BL 18.5 CM	46
SPLINTER FCPS WITH PIN SERRAT CVD 9.0 CM	77	STANDARD SCS TC CVD SH/BL 14.5 CM	46
SPLINTER FCPS WITH PIN SERRAT CVD10.5 CM	77	STANDARD SCS TC CVD SH/BL 16.5 CM	46
SPLINTER FCPS WITH PIN SERRAT CVD11.5 CM	77	STANDARD SCS TC CVD SH/BL 18.5 CM	46
SPLINTER FCPS WITH PIN SERRAT CVD13.0 CM	77	STANDARD SCS TC CVD SH/SH 14.5 CM	46
SPLINTER FCPS WITH PIN SERRAT CVD14.5 CM	77	STANDARD SCS TC CVD SH/SH 16.5 CM	46
SPLINTER FCPS WITH PIN SERRAT STR 8.5 CM	77	STANDARD SCS TC CVD SH/SH 18.5 CM	46
SPLINTER FCPS WITH PIN SERRAT STR 9.0 CM	77	STANDARD SCS TC STR BL/BL 16.5 CM	46
SPLINTER FCPS WITH PIN SERRAT STR10.5 CM	77	STANDARD SCS TC STR BL/BL 18.5 CM	46
SPLINTER FCPS WITH PIN SERRAT STR11.5 CM	77	STANDARD SCS TC STR SH/BL 14.5 CM	46
SPLINTER FCPS WITH PIN SERRAT STR13.0 CM	77	STANDARD SCS TC STR SH/BL 16.5 CM	46
SPLINTER FCPS WITH PIN SERRAT STR14.5 CM	77	STANDARD SCS TC STR SH/BL 18.5 CM	46
SPLINTER FCPS. SERRAT STR 10.5CM	77	STANDARD SCS TC STR SH/SH 14.5 CM	46
SPLINTER FCPS. SERRAT STR 11.5 CM	77	STANDARD SCS TC STR SH/SH 16.5 CM	46
SPLINTER FCPS. SERRAT STR 13.0CM	77	STANDARD SCS TC STR SH/SH 18.5 CM	46
SPLINTER FCPS. SERRAT STR 14.5 CM	77	STANDARD TISSUE FCPS., WITH PIN, 1X2 T STR 13.0 CM	70
SPLINTER FCPS. SERRAT STR 8.0 CM	77	STANDARD TISSUE FCPS., WITH PIN, 1X2 T STR 14.5 CM	70
SPLINTER FCPS. SERRAT STR 9.0 CM	77	STANDARD TISSUE FCPS., WITH PIN, 1X2 T STR 15.0 CM	70
SPLINTER FORCEPS, ANGLED, 10.0 CM	78	STANDARD TISSUE FCPS., WITH PIN, 1X2 T STR 16.0 CM	70
SPLINTER FORCEPS, STRAIGHT, 10.0 CM	78	STANDARD TISSUE FCPS., WITH PIN, 1X2 T STR 18.0 CM	70
ST.MARKS, RETRACTOR, FIG.1, 29.0 CM	186	STANDARD TISSUE FCPS., WITH PIN, 1X2 T STR 20.0 CM	70
ST.MARKS, RETRACTOR, FIG.2, 32.5 CM	186	STANDARD TISSUE FCPS., WITH PIN, 1X2 T STR 25.0 CM	70
ST.MARKS, RETRACTOR, FIG.3, 29.0 CM	186	STANDARD TISSUE FCPS., WITH PIN, 1X2 T STR 30.0 CM	70
ST.MARKS, RETRACTOR, FIG.4, 32.5 CM	186	STANDARD TROCER, W. SHIELD A. STOPCOCK, Ø 3,0 MM, 12,0 CM	218
STACKE EAR PROBE 1 MM DIAMETER 10.5 CM	214	STANDARD TROCER, W. SHIELD A. STOPCOCK, Ø 3,5 MM, 12,0 CM	218
STANDARD DRESSING FORCEPS STR 10.5 CM	64	STANDARD TROCER, W. SHIELD A. STOPCOCK, Ø 4,0 MM, 12,0 CM	218
STANDARD DRESSING FORCEPS STR 11.5 CM	64	STANDARD TROCER, W. SHIELD A. STOPCOCK, Ø 4,5 MM, 12,0 CM	218
STANDARD DRESSING FORCEPS STR 13.0 CM	64	STANDARD TROCER, W. SHIELD A. STOPCOCK, Ø 5,0 MM, 12,0 CM	218
STANDARD DRESSING FORCEPS STR 14.5 CM	64	STANDARD TROCER, W. SHIELD A. STOPCOCK, Ø 5,5 MM, 12,0 CM	218
STANDARD DRESSING FORCEPS STR 15.0 CM	64	STANDARD TROCER, W. SHIELD A. STOPCOCK, Ø 6,0 MM, 12,0 CM	218
STANDARD DRESSING FORCEPS STR 16.0 CM	64	STANDARD TROCER, W. SHIELD, Ø 3,0 MM, 11,0 CM	218
STANDARD DRESSING FORCEPS STR 18.0 CM	64	STANDARD TROCER, W. SHIELD, Ø 3,5 MM, 11,0 CM	218
STANDARD DRESSING FORCEPS STR 20.0 CM	64	STANDARD TROCER, W. SHIELD, Ø 4,0 MM, 11,0 CM	218
STANDARD DRESSING FORCEPS STR 25.0 CM	64	STANDARD TROCER, W. SHIELD, Ø 4,5 MM, 11,0 CM	218
STANDARD DRESSING FORCEPS STR 30.0 CM	64	STANDARD TROCER, W. SHIELD, Ø 5,0 MM, 11,0 CM	218
STANDARD OPER.SCS CVD SH/BL 10.5 CM	14	STANDARD TROCER, W. SHIELD, Ø 5,5 MM, 11,0 CM	218
STANDARD OPER.SCS CVD SH/BL 13.0 CM	14	STANDARD TROCER, W. SHIELD, Ø 6,0 MM, 11,0 CM	218
STANDARD OPER.SCS CVD SH/BL 17.5 CM	14	STANDARD TROCER, W.SHIELD, STOPCOCK A.TUBE, Ø 3.0 MM, 12,0 CM	218
STANDARD OPER.SCS STR. BL/BL 17.5 CM	14	STANDARD TROCER, W.SHIELD, STOPCOCK A.TUBE, Ø 3.5 MM, 12,0 CM	218
STANDARD OPER.SCS. CVD BL/BL 10.5 CM	14	STANDARD TROCER, W.SHIELD, STOPCOCK A.TUBE, Ø 4.0 MM, 12,0 CM	218
STANDARD OPER.SCS. CVD BL/BL 11.5 CM	14	STANDARD TROCER, W.SHIELD, STOPCOCK A.TUBE, Ø 4.5 MM, 12,0 CM	218
STANDARD OPER.SCS. CVD BL/BL 17.5 CM	14	STANDARD TROCER, W.SHIELD, STOPCOCK A.TUBE, Ø 5.0 MM, 12,0 CM	218
STANDARD OPER.SCS. CVD SH/SH 10.5 CM	15	STANDARD TROCER, W.SHIELD, STOPCOCK A.TUBE, Ø 5.5 MM, 12,0 CM	218
STANDARD OPER.SCS. CVD SH/SH 17.5 CM	15	STANDARD TROCER, W.SHIELD, STOPCOCK A.TUBE, Ø 6.0 MM, 12,0 CM	218
STANDARD OPER.SCS. CVD SH/SH 18.5 CM	15	STAUDE-MOORE, UTERINE TENACULUM FORCEPS, 17,0 CM	272
STANDARD OPER.SCS. CVD SH/SH 20.0 CM	15	STELZNER, LOBECTOMY AND RECTAL SCS., CURVED, BL/BL, 31.0 CM	42
STANDARD OPER.SCS. CVD.BL/BL 13.0 CM	14	STELZNER, LOBECTOMY AND RECTAL SCS., STRAIGHT, BL/BL, 31.0 CM	42
STANDARD OPER.SCS. CVD.BL/BL 14.5 CM	14	STERILIZING FORCEPS, 20.0 CM	308
STANDARD OPER.SCS. CVD.BL/BL 15.5 CM	14	STEVENS TENOTOM.SCS BLUNT CVD 10.5 CM	31
STANDARD OPER.SCS. CVD.BL/BL 16.5 CM	14	STEVENS TENOTOM.SCS BLUNT STR 10.5 CM	31
STANDARD OPER.SCS. CVD.BL/BL 18.5 CM	14	STEVENS TENOTOM.SCS POINTED CVD 10.5 CM	31
STANDARD OPER.SCS. CVD.BL/BL 20.0 CM	14	STEVENS TENOTOM.SCS POINTED STR 10.5 CM	31
STANDARD OPER.SCS. CVD.SH/BL 11.5 CM	14	STEVENS TENOTOM.SCS.CVD POINTED 11.5 CM	31
STANDARD OPER.SCS. CVD.SH/BL 14.5 CM	14	STEVENS TENOTOM.SCS.STR BLUNT 11.5 CM	31
STANDARD OPER.SCS. CVD.SH/BL 15.5 CM	14	STEVENS TENOTOM.SCS.STR POINTED 11.5CM	31

STEVENS, MICRO-SCISSORS, BAJONETT SHAPED HANDLE, 45° ANGLED, SH/SH, 18.5 CM	59	THOREK, DISSECTING SCISSORS, CURVED, 25.0 CM	27
STEVENS, MICRO-SCISSORS, BAJONETT SHAPED HANDLE, 45° ANGLED, SH/SH, 22.5 CM	59	THREE-WAY-STOPCOCK, 3 X LUER-LOCK FEMALE	229
STEVENS, MICRO-SCISSORS, BAJONETT SHAPED HANDLE, CURVED, LANCETTE SH/SH, 22.5 CM	59	TISCHLER-KEVORKIAN, CERVICAL BIOPSY FORCEPS	288
STEVENS, MICRO-SCISSORS, BAJONETT SHAPED HANDLE, CURVED, LANCETTESH/SH, 18.5 CM	59	TISCHLER-MORGAN, CERVICAL BIOPSY AND SPECIMEN FORCEPS, 21.0 CM	288
STEVENS, MICRO-SCISSORS, BAJONETT SHAPED HANDLE, LEFT CVD., SH/SH, 18.5 CM	59	TISSUE FCPS., DELICATE, CURVED, WITH PIN, 1X2 T STR 13.0 CM	70
STEVENS, MICRO-SCISSORS, BAJONETT SHAPED HANDLE, LEFT CVD., SH/SH, 22.5 CM	59	TISSUE FCPS., DELICATE, CURVED, WITH PIN, 1X2 T STR 14.5 CM	70
STEVENS, MICRO-SCISSORS, BAJONETT SHAPED HANDLE, RIGHT CVD., SH/SH, 18.5 CM	59	TISSUE FCPS., DELICATE, CURVED, WITH PIN, 1X2 T STR 16.0 CM	70
STEVENS, MICRO-SCISSORS, BAJONETT SHAPED HANDLE, RIGHT CVD., SH/SH, 22.5 CM	59	TISSUE FCPS., DELICATE, CURVED, WITH PIN, 1X2 T STR 18.0 CM	70
STEVENS, MICRO-SCISSORS, BAJONETT SHAPED HANDLE, STRAIGHT, LANCETTE SH/SH, 18.5 CM	59	TISSUE FCPS., DELICATE, CURVED, WITH PIN, 1X2 T STR 20.0 CM	70
STEVENS, MICRO-SCISSORS, BAJONETT SHAPED HANDLE, STRAIGHT, LANCETTE SH/SH, 22.5 CM	59	TISSUE FORCEPS 2X3 TEETH STR 11.5 CM	69
STEVENS, MICRO-SCISSORS, BAJONETT SHAPED HANDLE, STRAIGHT, SH/SH, 18.5 CM	59	TISSUE FORCEPS 2X3 TEETH STR 13.0 CM	69
STEVENS, MICRO-SCISSORS, BAJONETT SHAPED HANDLE, STRAIGHT, SH/SH, 22.5 CM	59	TISSUE FORCEPS 2X3 TEETH STR 14.5 CM	69
STEVENS, TENOTOMY SCS., SUPERCUT, CURVED, SH/SH, 11.0 CM	57	TISSUE FORCEPS 2X3 TEETH STR 16.0 CM	69
STEVENS, TENOTOMY SCS., SUPERCUT, STRAIGHT, SH/SH, 11.0 CM	57	TISSUE FORCEPS 2X3 TEETH STR 18.0 CM	69
STILLE DRESSING FORCEPS 15.0 CM	66	TISSUE FORCEPS 2X3 TEETH STR 20.0 CM	69
STILLE KIDNEY PED.CLAMP FCPS 23.0 CM	116	TISSUE FORCEPS 2X3 TEETH STR 25.0 CM	69
STILLE TISSUE FCPS 2X3 TEETH STR 15.0 CM	72	TISSUE FORCEPS 2X3 TEETH STR 30.0 CM	69
STILLE TISSUE FCPS STR 1X2 TEETH 15.0 CM	72	TISSUE FORCEPS 3X4 TEETH STR 13.0 CM	69
STILLE, CHISEL 10 MM, 20.0 CM	305	TISSUE FORCEPS 3X4 TEETH STR 14,5 CM	69
STILLE, CHISEL 12 MM, 20.0 CM	305	TISSUE FORCEPS 3X4 TEETH STR 16.0 CM	69
STILLE, CHISEL 15 MM, 20.0 CM	305	TISSUE FORCEPS 3X4 TEETH STR 18.0 CM	69
STILLE, CHISEL 25 MM 20.0 CM	305	TISSUE FORCEPS 3X4 TEETH STR 20.0 CM	69
STILLE, GOUGE 10 MM, 20.0 CM	305	TISSUE FORCEPS 3X4 TEETH STR 20.0 CM	69
STILLE, GOUGE 12 MM, 20.0 CM	305	TISSUE FORCEPS 4X5 TEETH STR 13.0 CM	69
STILLE, GOUGE 15 MM, 20.0 CM	305	TISSUE FORCEPS 4X5 TEETH STR 14.5 CM	69
STILLE, GOUGE 25 MM, 20.0 CM	305	TISSUE FORCEPS 4X5 TEETH STR 16.0 CM	69
STILLE, OSTEOTOME 15 MM, 20.0 CM	304	TISSUE FORCEPS 4X5 TEETH STR 18.0 CM	69
STILLE, OSTEOTOME 20 MM, 20.0 CM	304	TISSUE FORCEPS 4X5 TEETH STR 20.0 CM	69
STILLE, OSTEOTOME 25 MM, 20.0 CM	304	TISSUE FORCEPS NARROW 1X2 TEETH 14,5 CM	70
STILLE, OSTEOTOME, 10 MM, 20.0 CM	304	TISSUE FORCEPS NARROW 1X2 TEETH 15,5 CM	70
STOCKMANN MEATUS CLAMP W/O CATCH	240	TISSUE FORCEPS NARROW 1X2 TEETH 16.0 CM	70
STOPCOCK, 1 X LUER-LOCK MALE 2 X LUER-LOCK, FEMALE	229	TISSUE FORCEPS NARROW 1X2 TEETH 18.0 CM	70
STOPCOCK, LUER-LOCK, 1 X MALE, 1 X FEMALE	229	TISSUE FORCEPS NARROW 1X2 TEETH 20.0 CM	70
STOPCOCK, LUER-LOCK, FEMALE	229	TISSUE FORCEPS NARROW 1X2 TEETH 25.0 CM	70
STRABISMUS SCISSORS CVD BLUNT 11.5 CM	28	TISSUE FORCEPS NARROW 1X2 TEETH 30.0 CM	70
STRABISMUS SCISSORS CVD BLUNT 11.5 CM SC	57	TISSUE FORCEPS, ENGL. PATTERN, 1X2 T STR 13.0 CM	70
STRABISMUS SCISSORS STR BL. 11,5CM SC	57	TISSUE FORCEPS, ENGL. PATTERN, 1X2 T STR 14,5 CM	70
STRABISMUS SCISSORS STR BLUNT 11.5 CM	28	TISSUE FORCEPS, ENGL. PATTERN, 1X2 T STR 15.0 CM	70
STRATTE NEEDLE HOLDER 23.0 CM	128	TISSUE FORCEPS, NARROW STRAIGHT, 1X2 TEETH, 13.0 CM	70
STRATTE NEEDLE HOLDER TC CVD 22.0 CM	140	TISSUE FORCEPS, STANDARD, 1X2 TEEHT, STRAIGHT, 20.0 CM	69
STRATTE NEEDLE HOLDER TC CVD 23.0 CM	140	TISSUE FORCEPS, STANDARD, 1X2 TEETH, STRAIGHT, 18.0 CM	69
STRAUSS MEATUS CLAMP WITH RUBBER COVER	240	TISSUE FORCEPS, STANDARD, STRAIGHT, 1X2 TEETH, 16.0 CM	69
STRULLY NEUROSURGICAL SCS CVD 22.0 CM	34	TISSUE FORCEPS, STANDARD, 1X2 T STR 10.5 CM	69
SURGICAL SCISSORS, STANDARD WITH TUNGSTEN CARBIDE INSERTS STRAIGHT, BLUNT/BLUNT, 14.5 CM	46	TISSUE FORCEPS, STANDARD, 1X2 T STR 11,5 CM	69
SYRINGE, LUER, 1 ML	227	TISSUE FORCEPS, STANDARD, 1X2 T STR 13.0 CM	69
SYRINGE, LUER, 10 ML	227	TISSUE FORCEPS, STANDARD, 1X2 T STR 14,5 CM	69
SYRINGE, LUER, 2 ML	227	TISSUE FORCEPS, STANDARD, 1X2 T STR 15.0 CM	69
SYRINGE, LUER, 20 ML	227	TISSUE FORCEPS, STANDARD, 1X2 T STR 25.0 CM	69
SYRINGE, LUER, 30 ML	227	TISSUE FORCEPS, STANDARD, 1X2 T STR 30.0 CM	69
SYRINGE, LUER, 5 ML	227	TITAN BULLDOG CLAMPS, ARTERIA, 35MM, CVD	95
SYRINGE, LUER-LOCK, 1 ML	227	TITAN BULLDOG CLAMPS, ARTERIA, 35MM, STR	95
SYRINGE, LUER-LOCK, 10 ML	227	TITAN BULLDOG CLAMPS, ARTERIA, 40MM, CVD	95
SYRINGE, LUER-LOCK, 10 ML	228	TITAN BULLDOG CLAMPS, ARTERIA, 40MM, STR	95
SYRINGE, LUER-LOCK, 2 ML	227	TITAN BULLDOG CLAMPS, VENA, 35MM, CURVED	95
SYRINGE, LUER-LOCK, 20 ML	227	TITAN BULLDOG CLAMPS, VENA, 35MM, STR.	95
SYRINGE, LUER-LOCK, 20 ML	228	TITAN BULLDOG CLAMPS, VENA, 40MM, CURVED	95
SYRINGE, LUER-LOCK, 30 ML	228	TITAN BULLDOG CLAMPS, VENA, 40MM, STR.	95
SYRINGE, LUER-LOCK, 5 ML	227	TOENNIS ARTERY FORCEPS CVD 1X2 T 21.0 CM	111
SYRINGE, LUER-LOCK, 50 ML	227	TOENNIS ARTERY FORCEPS CVD 1X2 T 26.0CM	111
SYRINGE, LUER-LOCK, 50 ML	228	TOENNIS ARTERY FORCEPS CVD 21.0 CM	111
SYRINGE, THREERING-, LUER-LOCK, 10 ML	227	TOENNIS ARTERY FORCEPS CVD 26.0 CM	111
SYRINGE, THREERING-, LUER-LOCK, 2 ML	227	TOENNIS ARTERY FORCEPS STR 1X2 T. 21.0CM	111
SYRINGE, THREERING-, LUER-LOCK, 5 ML	227	TOENNIS ARTERY FORCEPS STR 1X2 T.,26,0CM	111
TAYLOR DRESSING FCPS BAY-SHAPED 17.5 CM	66	TOENNIS ARTERY FORCEPS STR 21.0 CM	111
TAYLOR DRESSING FORCEPS CVD 17.5 CM	66	TOENNIS ARTERY FORCEPS STR 26.0 CM	111
TAYLOR DRESSING FORCEPS STR 17.5 CM	66	TOENNIS DISS.SCISSORS CVD BL 18.0 CM	33
TAYLOR TISSUE FCPS BAY-SHAPED 17.5 CM	73	TOENNIS DISS.SCISSORS STR 18.0 CM	32
TAYLOR TISSUE FCPS CVD 1X2 TEETH 17.5 CM	73	TOENNIS NEEDLE HOLDER 18.0 CM	128
TAYLOR TISSUE FCPS STR 1X2 TEETH 17.5 CM	73	TOENNIS, NEEDLE HOLDER WITH TC, 18,0 CM	140
TEALE FCPS CVD 3X4 T. 23.0 CM	274	TOENNIS-ADSON DISS.SCS CVD 17.5 CM	24
TENOTOMY SCISSORS CVD BLUNT 11.5 CM	31	TOENNIS-ADSON SCS DELI TC CVD 17.5 CM	50
TERRIER, ARTERY FORCEPS STRAIGHT, 1X2 TEETH, 10.0 CM	98	TOENNIS-ADSON, DISSEC.-SCS. SUPERCUT, CURVED, BL/BL, 17.5 CM	56
THOMS-ALLIS INT.TISSUE FCPS. 6X7 20.0 CM	243	TOHOKU-JAPAN TOWEL FORCEPS	88
THOMS-GAYLOR, CERVICAL BIOPSY FORCEPS, 24.0 CM	286	TOHOKU-JAPAN TOWEL FORCEPS	88
THOMS-GAYLOR, CERVICAL BIOPSY FORCEPS, 24.0 CM	287	TOWEL FCPS WITH CLIP FOR TUBING 11.0 CM	86
THOMSON-WALKER, BLADDER RETRACTOR	237	TOWEL FCPS., FOR PAPER CLOTHS, 13,5 CM	87
THOREK, DISSECTING SCISSORS, CURVED, 19,0 CM	27	TRELAT LIGATURE NEEDLE 23.0 CM	150
		TREVES, TISSUE FCPS., 1X2 TEETH, 13.0 CM	76
		TREVES, TISSUE FCPS., 1X2 TEETH, 15.0 CM	76
		TUBERCULINE SYRINGE, LUER-LOCK, 1 ML	228
		TUBING CLAMP 15.5 CM	91
		TUBING CLAMP 15.5 CM WITH CLIP	91
		TUBING CLAMP 18.0 CM	91
		TUBING CLAMP 20.0 CM	91
		TUBING CLAMP 20.0 CM WITH CLIP	91
		TUFFIER ABDOMINAL SPATULA 20.0 CM	210
		TUFFIER ARTERY FORCEPS 5X4 TEETH 13.0 CM	96
		TUFFIER RIB SPREADER 50X45MM/165MM	211
		TUOHY NEEDLE,76 MM X 16 G	226
		TUOHY NEEDLE,76 MM X 17 G	226
		TUOHY NEEDLE,76 MM X 18 G	226

Inhaltsverzeichnis  
Index

TURNER-WARWICK MODIF., ABDOMINAL RETRACTOR, FRAME ONLY, 455 x 330 MM			
203			
TURNER-WARWICK MODIF., ABDOMINAL RETRACTOR, FRAME ONLY, Ø 180 MM	203		
TURNER-WARWICK MODIF., ABDOMINAL RETRACTOR, FRAME ONLY, Ø 230 MM	203		
TURNER-WARWICK MODIF., ABDOMINAL RETRACTOR, FRAME ONLY, Ø 305 MM	203		
TURNER-WARWICK MODIF., ABDOMINAL RETRACTOR, VALVES ONLY, 114X60 MM	204		
TURNER-WARWICK MODIF., ABDOMINAL RETRACTOR, VALVES ONLY, 13 MM	204		
TURNER-WARWICK MODIF., ABDOMINAL RETRACTOR, VALVES ONLY, 19X76 MM	204		
TURNER-WARWICK MODIF., ABDOMINAL RETRACTOR, VALVES ONLY, 38X102 MM,			
WITHOUT SLIDING PART, STAINLESS FINISH	204		
TURNER-WARWICK MODIF., ABDOMINAL RETRACTOR, VALVES ONLY, 51x38 MM MM	204		
TURNER-WARWICK MODIF., ABDOMINAL RETRACTOR, VALVES ONLY, 57X114 MM	204		
TURNER-WARWICK MODIF., ABDOMINAL RETRACTOR, VALVES ONLY, 57X89 MM			
WITHOUT SLIDING PART, STAINLESS FINISH	204		
TURNER-WARWICK MODIF., ABDOMINAL RETRACTOR, VALVES ONLY, 76X60 MM,			
WITHOUT SLIDING PART, STAINLESS FINISH	204		
TURNER-WARWICK MODIF., ABDOMINAL RETRACTOR, VALVES ONLY, 89X60 MM	204		
TURNER-WARWICK, GALL STONE FORCEPS, FIG. 1, 18,0 CM	233		
TURNER-WARWICK, GALL STONE FORCEPS, FIG. 3, 17,5 CM	233		
UCKERMANN COTTON APPLICATOR 15 CM W.HOLE	216		
ULRICH POLYPUS FORCEPS CURVED 22.0 CM	89		
ULRICH POLYPUS FORCEPS CURVED 25.0 CM	89		
ULRICH POLYPUS FORCEPS CURVED 27.0 CM	89		
ULRICH POLYPUS FORCEPS STRAIGHT 22.0 CM	89		
ULRICH POLYPUS FORCEPS STRAIGHT 25.0 CM	89		
ULRICH POLYPUS FORCEPS STRAIGHT 27.0 CM	89		
UNIVERSAL BANDAGE SCISSORS 14.0 CM	45		
UNIVERSAL BANDAGE SCISSORS 16.0 CM	45		
UNIVERSAL BANDAGE SCISSORS 18.0 CM	45		
UNIVERSAL TROCARS SET OF 3 FLAT HDL.	218		
UNIVERSAL TROCARS SET OF 4 FLAT HDL.	218		
UNIVERSAL TROCARS, SET OF 3 PCS., ROUND HANDLE	219		
UNIVERSAL TROCARS, SET OF 4 PCS., ROUND HANDLE	219		
UNIVERSAL WIRE SCISSORS SAW EDGE 12.0 CM	44		
UNIVERSAL WIRE SHEARS TC 12.0 CM	55		
UNNA, COMEDO EXTRACTOR, Ø OVAL, 14,0 CM	295		
UNNA, COMEDO EXTRACTOR, Ø ROUND, 14,0 CM	295		
URO-TANGENTIAL FORCEPS 26CM	117		
URO-TANGENTIAL FORCEPS 28CM	117		
UTERINE CURETTE BLUNT MALLE 26 CM 21 MM	281		
UTERINE CURETTE BLUNT MALLE 26 CM 23 MM	281		
UTERINE CURETTE BLUNT MALLE 31 CM 21 MM	283		
UTERINE CURETTE BLUNT MALLE 31 CM 23 MM	283		
UTERINE CURETTE BLUNT RIGID 26 CM 21 MM	281		
UTERINE CURETTE BLUNT RIGID 26 CM 23 MM	281		
UTERINE CURETTE BLUNT RIGID 31 CM 21 MM	283		
UTERINE CURETTE BLUNT RIGID 31 CM 23 MM	283		
UTERINE CURETTE SH.MALLE 31 CM 21 MM	282		
UTERINE CURETTE SH.MALLE 31 CM 23 MM	282		
UTERINE CURETTE SHARP MALLE 26 CM 21 MM	280		
UTERINE CURETTE SHARP MALLE 26 CM 23 MM	280		
UTERINE PERFORATOR, MOD. ERLANGEN MODIF., Ø 2,5 MM, 25,0 CM	279		
UTERUS CURETTE SHARP RIGID 31 CM 21 MM	282		
UTERUS CURETTE SHARP RIGID 31 CM 23 MM	282		
VALLEIX UTERINE PROBE W.SLIDE 25.0 CM	277		
VERRES NEEDLE 2.0X100 MM	225		
VERRES NEEDLE 2.0X150 MM	225		
VERRES TUBES 2,0 X 120MM	225		
VESSEL DILATOR Ø 0.3 MM, BLUNT, 12.5 CM	81		
VESSEL DILATOR Ø 0.3 MM, BLUNT, 13.5 CM	81		
VESSEL DILATORS CURVED, Ø 0.4 MM, 12.0 CM	81		
VESSEL DILATORS, 0,3 MM, 11.0 CM	80		
VESSEL DILATORS, 0,3 MM, 45° ANGLED, 11.0 CM	80		
VESSEL DILATORS, 0,3 MM, 45° ANGLED, 13.5 CM	81		
VESSEL DILATORS, 0,3 MM, 90° ANGLED, 11.0 CM	80		
VESSEL DILATORS, DIAMOND COATED, 0,3 MM, 45° ANGLED, 11.0 CM	80		
VIRCHOW, BRAIN KNIFE, BLADE 16.0 CM	9		
VIRCHOW, BRAIN KNIFE, BLADE 20.0 CM	9		
VIRCHOW, BRAIN KNIFE, BLADE 24.0 CM	9		
VOLKMANN BONE CURETTE, FIG.00	298		
VOLKMANN BONE CURETTE, FIG.000	298		
VOLKMANN BONE CURETTE, FIG.0000	298		
VOLKMANN BONE CURETTE, FIG.1	298		
VOLKMANN BONE CURETTE, FIG.2	298		
VOLKMANN BONE CURETTE, FIG.3	298		
VOLKMANN BONE CURETTE, FIG.4	298		
VOLKMANN BONE CURETTE, FIG.5	298		
VOLKMANN BONE CURETTE, FIG.6	298		
VOLKMANN CURETTE FIG.0	298		
VOLKMANN RETR.BLUNT 1 PRONG 21.5 CM	171		
VOLKMANN RETR.BLUNT 2 PRONGS 21.5 CM	171		
VOLKMANN RETR.BLUNT 3 PRONGS 21.5 CM	171		
VOLKMANN RETR.BLUNT 4 PRONGS 21.5 CM	171		
VOLKMANN RETR.BLUNT 6 PRONGS 21.5 CM	171		
VOLKMANN RETR.SEMI-SHARP 2 PRONGS 21.5CM	170		
VOLKMANN RETR.SEMI-SHARP 3 PRONGS 21.5CM	170		
VOLKMANN RETR.SEMI-SHARP 4 PRONGS 21.5CM	170		
VOLKMANN RETR.SEMI-SHARP 6 PRONGS 21.5CM	170		
VOLKMANN RETR.SHARP 1 PRONG 21.5 CM	170		
VOLKMANN RETR.SHARP 2 PRONGS 21.5 CM	170		
VOLKMANN RETR.SHARP 3 PRONGS 21.5 CM	170		
VOLKMANN RETR.SHARP 4 PRONGS 21.5 CM	170		
VOLKMANN RETR.SHARP 6 PRONGS 21.5 CM	170		
VOLKMANN, BONE CURETTE OVAL/OVAL, 13.0 CM	300		
VOLKMANN, BONE CURETTE OVAL/OVAL, 14.0 CM	300		
VOLKMANN, BONE CURETTE, OVAL/OVAL, 17.0 CM	300		
VOLKMANN, RETRACTOR SEMI-SHARP, 1 PRONG, 21,5 CM	170		
VOLKMANN, RETRACTOR, 8 PRONGS, SEMI-SHARP, 21,5 CM	170		
VOLKMANN, RETRACTOR, 8 PRONGS, BLUNT, 21,5 CM	171		
VOLKMANN, RETRACTOR, 8 PRONGS, SHARP, 21,5 CM	170		
WACHENFELDT SUTURE FORCEPS 12.5 CM	154		
WAGNER FINE SCISSORS CVD BL/BL 12.0 CM	28		
WAGNER FINE SCISSORS CVD SH/SH 12.0 CM	28		
WAGNER FINE SCISSORS STR BL/BL 12.0 CM	28		
WAGNER FINE SCISSORS STR SH/SH 12.0 CM	28		
WALB, BRAIN KNIFE, BLADE 11,0 CM	9		
WALB, BRAIN KNIFE, BLADE 14,0 CM	9		
WALB, BRAIN KNIFE, BLADE 17,0 CM	9		
WALDMANN EPISIOTOMY SCS SAW EDGE 18.0 CM	43		
WALLICH OVUM SCOOPS, 42,0CM	292		
WALTER-CARMALT SPLINTER FCPS CVD 10.5 CM	78		
WALTER-CARMALT SPLINTER FCPS STR 10.5 CM	78		
WANGENSTEEN NEEDLE HOLDER 27.0 CM	127		
WANGENSTEEN TISSUE FORCEPS TC 15.0 CM	82		
WANGENSTEEN TISSUE FORCEPS TC 23.0 CM	82		
WANGENSTEEN, NEEDLE HOLDER WITH TC, 27.0 CM	138		
WANGENSTEEN, TISSUE FORCEPS, TC, 25.0 CM	82		
WATSON-CHEYNE, DISSECTOR, 17,5 CM	301		
WAUGH, DRESSING FORCEPS, 15,0 CM	68		
WAUGH, DRESSING FORCEPS, 20,0 CM	68		
WAUGH, TISSUE FCPS., 1X2 T, SERRATED, 15,0 CM	74		
WAUGH, TISSUE FCPS., 1X2 T, SERRATED, 20,0 CM	74		
WEBSTER NEEDLE HOLDER SMOOTH JAWS 13.0CM	124		
WEBSTER NEEDLE HOLDER TC 13.0 CM	133		
WEBSTER NEEDLE HOLDER TC, SMOOTH, 13,0 CM	133		
WEISSBARTH, VAGINAL SPECULA, W. REMOVABLE WIRE BASKET	260		
WEITLANER RETRACTOR BLUNT 13.0 CM	191		
WEITLANER RETRACTOR BLUNT 16.5 CM	191		
WEITLANER RETRACTOR BLUNT 20.0 CM	191		
WEITLANER RETRACTOR SHARP 13.0 CM	191		
WEITLANER RETRACTOR SHARP 16.5 CM	191		
WEITLANER RETRACTOR SHARP 20.0 CM	191		
WEITLANER-BABY RETRACTOR 13.0 CM	193		
WEITLANER-LOKTITE, RETRACTOR SELF-RETAINING, BLUNT 2X3 TEETH, 10,5 CM	191		
WEITLANER-LOKTITE, RETRACTOR SELF-RETAINING, SHARP 2X3 TEETH, 10,5 CM	191		
WERTHEIM CLAMP-FCPS EXTRA STRONG 24,0CM	119		
WERTHEIM CLAMP-FORCEPS 25.0 CM	119		
WERTHEIM OPER.SCISSORS CVD BL/BL 19.5 CM	41		
WERTHEIM OPER.SCISSORS CVD BL/BL 22.5 CM	41		
WERTHEIM, VAGINAL SPECULA, 95X38MM	268		
WERTHEIM-CULLEN CLAMP-FORCEPS 21.5 CM	120		
WESTCOTT TENOTOMY SCISSORS BLUNT 11.0 CM	59		
WESTCOTT TENOTOMY SCS.POINTE 11.0 CM	59		
WIKSTROEM DISS.AND LIG.FCPS.CVD 19.0 CM	112		
WIKSTROEM DISS.AND LIG.FCPS.CVD 21.0 CM	112		
WIKSTROEM DISS.AND LIG.FCPS.CVD 24.0 CM	112		
WILLAUER, LOBECTOMY AND RECTAL SCS., STRAIGHT, BL/BL, 25.0 CM	42		
WILLAUER, LOBECTOMY AND RECTAL SCS., STRAIGHT, BL/BL, 25.0 CM	42		
WILLAUER, LOBECTOMY AND RECTAL SCS., STRAIGHT, BL/BL, 28.0 CM	42		
WILLAUER, LOBECTOMY AND RECTAL SCS., STRAIGHT, BL/BL, 28.0 CM	42		
WILLET-MARTEL SCALP FLAP FORCEPS 19,0 CM	97		
WILLIAMS, INTESTINAL GRASPING FORCEPS, 16,0 CM	244		
WILLIGER ELEVATOR 16.0 CM	301		
WILLIGER ELEVATOR 17.0 CM	301		
WILLIGER, BONE CURETTE FIG.00/0, 14.0 CM	300		
WILLIGER, BONE CURETTE FIG.1/2, 14.0 CM	300		
WILLIGER, BONE CURETTE, FIG.0/1, 14.0 CM	300		
WILLIGER, PERIOSTEAL RASPATORY, 8 MM, 16,0 CM	303		
WILLIGER, PERIOSTEAL RASPATORY, 4 MM, 16,0 CM	303		
WILLIGER, PERIOSTEAL RASPATORY, 6 MM, 16,0 CM	303		
WILLIGER, SHARP SPOON FIG. 2, OVAL, 17,0 CM	300		
WILLIGER, SHARP SPOON FIG.1, OVAL, 17,0 CM	300		
WINTER OVUM FORCEPS, FIG.3,STR.,28.0CM	291		
WINTER OVUM FORCEPS, STRAIGHT, 27,0CM	291		
WINTER OVUM FORCEPS,FIG.1,CURVED 28.0CM	291		
WINTER OVUM FORCEPS,FIG.1,STR.,28.0CM	291		
WINTER OVUM FORCEPS,FIG.2,CURVED 28.0CM	291		
WINTER OVUM FORCEPS,FIG.2,STR.,28.0CM	291		
WINTER OVUM FORCEPS,FIG.3,CURVED,28.0CM	291		
WIRE TWISTING FORCEPS, WITH TC-INSERTS, 20.0 CM	139		
WITTNER BIOPSY FORCEPS CURVED 23.0 CM	287		
WITTNER BIOPSY FORCEPS STRAIGHT 23.0 CM	287		
WRIGLEY, OBSTETRICAL FORCEPS, 28,0CM	289		
WULLSTEIN, SELF-RETAINING RETRACTOR, BLUNT, 3X3 PRONGS, 10,5 CM	190		
WULLSTEIN, SELF-RETAINING RETRACTOR, BLUNT, 3X3 PRONGS, 13,5 CM	190		
WULLSTEIN, SELF-RETAINING RETRACTOR, BLUNT, 3X3 PRONGS, 15,0 CM	190		
WULLSTEIN, SELF-RETAINING RETRACTOR, BLUNT, 3X3 PRONGS, 18,0 CM	190		

WULLSTEIN, SELF-RETAINING RETRACTOR, SHARP, 3X3 PRONGS, 15,0 CM	190
WULLSTEIN, SELF-RETAINING RETRACTOR, SHARP, 3X3 PRONGS, 18,0 CM	190
WULLSTEIN, SELF-RETAINING RETRACTOR, SHARP, 3X3PRONGS, 10,5 CM	190
WULLSTEIN, SELF-RETAINING RETRACTOR, SHARP, 3X3PRONGS, 13,0 CM	190
YANKAUER, SUCTION TUBE, CENTRAL HOLE Ø 2.0 MM, OUTER DIAM. 6.0MM	28.5 CM
222	
YEOMAN RECTAL BIOPSY FCPS FIG.1 28.0 CM	255
YEOMAN RECTAL BIOPSY FCPS FIG.1 35.0 CM	255
YEOMAN RECTAL BIOPSY FCPS FIG.1 42.0 CM	255
YEOMAN RECTAL BIOPSY FCPS FIG.2 28.0 CM	255
YEOMAN RECTAL BIOPSY FCPS FIG.2 35.0 CM	255
YEOMAN RECTAL BIOPSY FCPS FIG.2 42.0 CM	255
YEOMAN RECTAL BIOPSY FCPS FIG.3 28.0 CM	255
YEOMAN RECTAL BIOPSY FCPS FIG.3 35.0 CM	255
YEOMAN RECTAL BIOPSY FCPS FIG.3 42.0 CM	255
YEOMAN RECTAL BIOPSY FCPS FIG.4 28.0 CM	255
YEOMAN RECTAL BIOPSY FCPS FIG.4 35.0 CM	255
YEOMAN RECTAL BIOPSY FCPS FIG.4 42.0 CM	255
YOUNG PROSTATIC RETRACTOR 21CM	239
YOUNG PROSTATIC RETRACTOR 21CM	239
YOUNG PROSTATIC RETRACTOR 22CM	239
YOUNG PROSTATIC RETRACTOR 22CM	239
ZENKER DISS.FCPS SLIGHTLY CVD 29.5 CM	113
ZENKER DISS.FCPS STRONGLY CVD 29.5 CM	113
ZENKER RETRACTOR 35X8 MM 26.0 CM	182
ZENKER RETRACTOR 60X12 MM 26.0 CM	182
ZENKER RETRACTOR 75X12 MM 26.0 CM	182
ZWEIFEL NEEDLE HOLDER TC 20.0 CM	143
ZWEIFEL NEEDLE HOLDER TC 23.0 CM	143